

Canon

Large Format Printer

 **imagePROGRAF**

iPF6100

User Manual

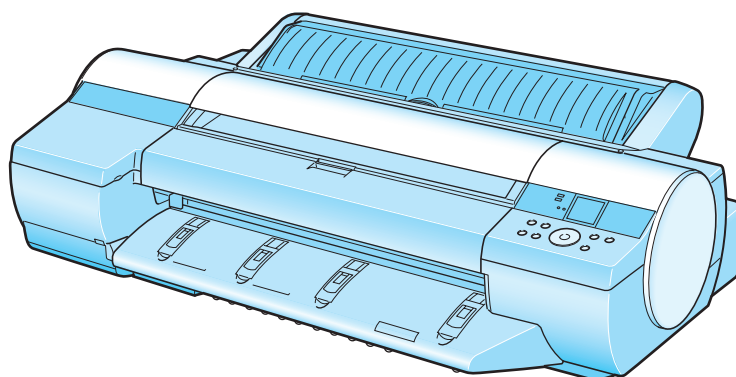

ENG

Contents

Introduction 1

How to use this manual	1
About This User Manual	1
Viewing Videos of Explanations	3
HTML Version of the Manual for Printing.....	4

Printer Parts 8

Printer parts	8
Front	8
Back	9
Top Cover (Inside)	10
Tray Feed Area	11
Roll Paper Unit Cover (Inside).....	12
Carriage.....	13
Ink Tank Cover (Inside).....	14
Control Panel.....	15
Vents	18
Control Panel	19
Turning the Printer On and Off	19
Printer Modes	21
Switching Modes	26
Printer Menu Operations	29
Main Menu Operations	30
Menu Structure	35
Main Menu Settings.....	49
Main Menu Settings (During Printing)	59
Submenu Display	61
Status Print.....	62
Optional accessories	69
Stand	69
Roll Holder Set	70
IEEE 1394 Expansion Board.....	71
Printer Specifications	72
Specifications	72
Basic Environmental Performance	77
Print Area.....	78

Basic Printing Workflow	80
Printing procedure	80
Loading and Printing on Rolls	80
Loading and Printing on Sheets in the Paper Feed Slot	85
Printing Options Using Rolls and Sheets	87
Printing from Windows	88
Printing from Mac OS X.....	89
Printing from Mac OS 9	91
Specifying Paper in the Printer Driver (Windows)	93
Specifying Paper in the Printer Driver (Mac OS X)	95
Specifying Paper in the Printer Driver (Mac OS 9).....	97
Canceling print jobs	99
Canceling Print Jobs from the Control Panel	99
Canceling Print Jobs from Windows.....	101
Canceling Print Jobs from Mac OS X.....	103
Canceling Print Jobs from Mac OS 9	105
Handling Paper	107
Paper	107
Paper.....	107
Types of Paper	108
Paper Sizes	113
Handling rolls	115
Selecting the Roll as the Paper Source.....	115
Loading Rolls on the Roll Paper Holder	116
Removing Rolls From the Roll Holder	118
Loading Rolls in the Roll Feed Unit	119
Removing Rolls from the Roll Feed Unit	122
Selecting the Paper Type (Roll).....	124
Specifying the Paper Length (Roll).....	125
Feeding Roll Paper Manually	126
Detection of the Remaining Roll Paper	127
Cutting the Leading Edge of Roll Paper Automatically	128
Specifying the Cutting Method for Rolls	129
Reducing Dust from Cutting Rolls	134
Specifying the Ink Drying Time for Rolls.....	135
Clearing Jammed Roll Paper	138
Clearing Jammed Paper (Paper Feed Slot)	142
Roll Holder Set	143
Attaching Accessories to the Roll Holder	144
Feeding Paper from the Roll Feed Unit.....	146
Removing the Roll Feed Unit	147
Installing the Roll Feed Unit	148
Accessing the Printer Driver Dialog Box from the Operating System Menu (Windows)	149
Media Detailed Settings Dialog Box (Windows)	151
Media Detailed Settings Dialog Box (Mac OS X)	152
Media Detailed Settings Dialog Box (Mac OS 9).....	153

Handling sheets for paper feed slots	154
Selecting the Sheet as the Paper Source	154
Loading Sheets Manually	156
Selecting the Paper Type (Sheet).....	162
Selecting the Paper Size (Sheet)	163
Removing Sheets from the Top Paper Feed Slot	164
Removing Heavyweight Paper from the Front Paper Feed Slot	165
Clearing Jammed Paper from the Tray	166
Output Stacker	169
Using the Output Stacker	169
Output Stacker Precautions	171

Enhanced Printing Options 172

Print quality and color settings	172
Choosing a Paper for Printing	172
Giving Priority to Particular Graphic Elements and Colors for Printing	173
Printing Photos and Images (Windows, Mac OS X).....	177
Printing Photos and Images (Mac OS 9).....	179
Printing Line Drawings and Text (Windows, Mac OS X).....	181
Printing Line Drawings and Text (Mac OS 9).....	182
Printing Office Documents.....	183
Adjusting the Color in the Printer Driver	184
Printing in Ideal Colors for Light in the Viewing Environment.....	188
Printing Photos in Monochrome	189
Choosing the Document Type and Printing Conditions (Windows).....	190
Choosing the Document Type and Printing Conditions (Mac OS X)	192
Choosing the Document Type and Printing Conditions (Mac OS 9).....	195
Fine-Tuning Colors of Photos and Images (Windows)	198
Fine-Tuning Colors of Photos and Images (Mac OS X)	201
Fine-Tuning Colors of Photos and Images (Mac OS 9).....	204
Fine-Tuning Monochrome Settings When Printing Photos (Windows).....	207
Fine-Tuning Monochrome Settings When Printing Photos (Mac OS X).....	209
Fine-Tuning Monochrome Settings When Printing Photos (Mac OS 9)	212
Printing Line Drawings and Text (Windows).....	215
Printing Line Drawings and Text (Mac OS X)	217
Printing Line Drawings and Text (Mac OS 9).....	220
Printing Office Documents (Windows).....	222
Printing Office Documents (Mac OS X).....	224
Printing Office Documents (Mac OS 9)	226
Printing Photos and Images (Windows)	228
Printing Photos and Images (Mac OS X)	230
Printing Photos and Images (Mac OS 9).....	233
Printing Photos in Monochrome (Windows)	236
Printing Photos in Monochrome (Mac OS X)	238
Printing Photos in Monochrome (Mac OS 9).....	241

Printing enlargements or reductions	244
Resizing Originals to Match the Paper Size	244
Resizing Originals to Fit the Roll Width	245
Resizing Originals by Entering a Scaling Value.....	246
Printing Enlargements of Scanned Originals from a Color imageRUNNER.....	247
Printing Enlargements of Scanned Originals from a Color imageRUNNER (Windows).....	248
Printing Enlargements of Scanned Originals from a Color imageRUNNER (Mac OS X).....	250
Resizing Originals by Entering a Scaling Value (Windows).....	252
Resizing Originals by Entering a Scaling Value (Mac OS X).....	254
Resizing Originals by Entering a Scaling Value (Mac OS 9)	257
Resizing Originals to Fit the Roll Width (Windows)	261
Resizing Originals to Fit the Roll Width (Mac OS X)	263
Resizing Originals to Fit the Roll Width (Mac OS 9).....	266
Resizing Originals to Match the Paper Size (Windows)	269
Resizing Originals to Match the Paper Size (Mac OS X)	271
Resizing Originals to Match the Paper Size (Mac OS 9).....	274
Printing at full size	277
Printing on Oversized Paper	277
Borderless Printing at Actual Size	279
Borderless Printing at Actual Size (Windows)	281
Borderless Printing at Actual Size (Mac OS X)	283
Borderless Printing at Actual Size (Mac OS 9).....	286
Printing at Full Size (Windows)	290
Printing at Full Size (Mac OS X).....	292
Printing at Full Size (Mac OS 9)	295
Borderless Printing	297
Borderless Printing on Paper of Equivalent Size.....	297
Borderless Printing by Resizing Originals to Fit the Roll Width.....	299
Borderless Printing at Actual Size	301
Borderless Printing at Actual Size (Windows)	303
Borderless Printing at Actual Size (Mac OS X)	305
Borderless Printing at Actual Size (Mac OS 9).....	308
Borderless Printing by Resizing Originals to Fit the Roll Width (Windows).....	312
Borderless Printing by Resizing Originals to Fit the Roll Width (Mac OS X).....	314
Borderless Printing by Resizing Originals to Fit the Roll Width (Mac OS 9)	317
Borderless Printing by Resizing Originals to Match the Paper Size (Windows).....	321
Borderless Printing by Resizing Originals to Match the Paper Size (Mac OS X)	323
Borderless Printing by Resizing Originals to Match the Paper Size (Mac OS 9)	326
Printing banners or at other non-standard sizes	330
Printing Vertical or Horizontal Banners (Large-Format Printing)	330
Printing on Non-Standard Paper Sizes	331
Printing on Non-Standard Paper Sizes (Windows)	332
Printing on Non-Standard Paper Sizes (Mac OS X).....	336
Printing on Non-Standard Paper Sizes (Mac OS 9)	338
Printing Vertical or Horizontal Banners (Large-Format Printing; Windows).....	341
Printing Vertical or Horizontal Banners (Large-Format Printing; Mac OS X).....	345
Printing Vertical or Horizontal Banners (Large-Format Printing; Mac OS 9)	348

Tiling and multiple pages per sheet	352
Printing Multiple Originals Next to Each Other	352
Printing Multiple Pages Continuously	354
Printing Multiple Pages Per Sheet.....	355
Printing Posters in Sections	356
Printing Large Posters (Windows).....	357
Printing Large Posters (Mac OS 9)	359
Printing Multiple Originals Next to Each Other (Windows)	361
Printing Multiple Originals Next to Each Other (Mac OS X)	363
Printing Multiple Pages Continuously (Windows).....	365
Printing Multiple Pages Continuously (Mac OS X)	366
Printing Multiple Pages Continuously (Mac OS 9)	368
Printing Multiple Pages Per Sheet (Windows).....	370
Printing Multiple Pages Per Sheet (Mac OS X).....	372
Printing Multiple Pages Per Sheet (Mac OS 9)	375
Centering originals	378
Printing Originals Centered on Rolls	378
Printing Originals Centered on Sheets	379
Printing Originals Centered on Rolls (Windows)	380
Printing Originals Centered on Rolls (Mac OS X)	382
Printing Originals Centered on Rolls (Mac OS 9).....	385
Printing Originals Centered on Sheets (Windows)	388
Printing Originals Centered on Sheets (Mac OS X)	390
Printing Originals Centered on Sheets (Mac OS 9).....	392
Conserving roll paper	395
Conserving Roll Paper by Rotating Originals 90 Degrees	395
Conserving Roll Paper by Printing Originals Without Top and Bottom Margins	396
Conserving Roll Paper by Printing Originals Without Top and Bottom Margins (Windows)	397
Conserving Roll Paper by Printing Originals Without Top and Bottom Margins (Mac OS X) ..	399
Conserving Roll Paper by Printing Originals Without Top and Bottom Margins (Mac OS 9)...	402
Conserving Roll Paper by Rotating Originals 90 Degrees (Windows)	404
Conserving Roll Paper by Rotating Originals 90 Degrees (Mac OS X).....	406
Conserving Roll Paper by Rotating Originals 90 Degrees (Mac OS 9)	409
Printing CAD Drawings	411
Printing CAD Drawings.....	411
Printing Line Drawings and Text (Windows).....	412
Printing Line Drawings and Text (Mac OS X)	414
Printing Line Drawings and Text (Mac OS 9).....	417
Other useful settings	419
Printing With Watermarks.....	419
Making the Original Orientation Match the Paper Orientation	420
Using Favorites	421
Cutting Roll Paper After Printing.....	421
Printing from Photoshop.....	422
Using PosterArtist to Compose Originals	423
Cutting Roll Paper After Printing (Windows).....	424
Cutting Roll Paper After Printing (Mac OS X).....	425
Cutting Roll Paper After Printing (Mac OS 9)	427

Making the Original Orientation Match the Paper Orientation (Windows).....	429
Making the Original Orientation Match the Paper Orientation (Mac OS X)	431
Making the Original Orientation Match the Paper Orientation (Mac OS 9)	434
Printing with Watermarks-COPY, FILE COPY, and so on (Windows).....	436
Printing with Watermarks-COPY, FILE COPY, and so on (Mac OS 9)	438

Software

441

Windows	441
Printer Driver Settings (Windows)	441
Confirming Print Settings (Windows).....	443
Previewing Images Before Printing (Windows)	445
Paper Information on Printer Dialog Box (Windows).....	446
Settings Summaries Dialog Box (Windows).....	447
Using Favorites (Windows)	448
Main Sheet (Windows)	450
Page Setup Sheet (Windows)	454
Layout Sheet (Windows)	456
Gray Adjustment Sheet (Windows)	458
Favorites Sheet (Windows)	459
Utility Sheet (Windows)	460
Support Sheet (Windows)	461
Device Settings Sheet (Windows).....	462
Using PosterArtist to Compose Originals (Windows).....	463
Printing Adobe RGB Images (Windows)	465
imagePROGRAF Status Monitor (Windows).....	468
imagePROGRAF Device Setup Utility.....	469
Installing imagePROGRAF Device Setup Utility	470
Configuring the IP Address Using imagePROGRAF Device Setup Utility.....	471
Digital Photo Front-Access.....	472
Accessing the Printer Driver Dialog Box from Applications (Windows)	473
Accessing the Printer Driver Dialog Box from the Operating System Menu (Windows)	475
Color Settings Sheet: Color (Windows).....	477
Color Settings Sheet: Monochrome (Windows)	483
Confirming the Print Image Before Printing.....	485
Media Detailed Settings Dialog Box (Windows)	486
Media Size Options Dialog Box (Windows).....	487
Printing Enlargements of Scanned Originals from a Color imageRUNNER (Windows).....	488
Special Settings Dialog Box (Windows)	490
View Settings Dialog Box for the Printing Application (Windows).....	491
Mac OS X	492
Printer Driver Settings (Mac OS X)	492
Confirming Print Settings (Mac OS X).....	493
Checking the Layout Before Printing.....	495
Checking the Layout Before Printing (Mac OS X)	496
Previewing Images Before Printing (Mac OS X)	497
Paper Information on Printer Dialog Box (Mac OS X)	498
Main Pane (Mac OS X)	499
Page Setup Pane (Mac OS X)	501
Utility Pane (Mac OS X)	503

Gray Adjustment Pane (Mac OS X).....	504
Additional Settings Pane (Mac OS X)	505
Support Pane (Mac OS X).....	506
Using Favorites (Mac OS X).....	506
Printing Adobe RGB Images (Mac OS X).....	507
imagePROGRAF Printmonitor (Macintosh).....	510
Accessing the Printer Driver Dialog Box from Applications (Mac OS X)	511
Color Settings Pane: Color (Mac OS X)	512
Color Settings Pane: Monochrome (Mac OS X).....	514
Media Detailed Settings Dialog Box (Mac OS X)	515
View Settings Dialog Box for the Printing Application (Mac OS X).....	516
Mac OS 9.....	517
Printer Driver Settings (Mac OS 9).....	517
Confirming Print Settings (Mac OS 9)	518
Previewing Images Before Printing (Mac OS 9).....	520
Main Pane (Mac OS 9).....	521
Page Setup Pane (Mac OS 9).....	523
Finishing Pane (Mac OS 9)	525
Gray Adjustment Pane (Mac OS 9)	526
Device Settings Pane (Mac OS 9).....	527
Additional Settings Pane (Mac OS 9).....	528
Using Favorites (Mac OS 9)	529
Printing Adobe RGB Images (Mac OS 9)	531
imagePROGRAF Printmonitor (Macintosh).....	534
Accessing the Printer Driver Dialog Box from Applications (Mac OS 9).....	535
Color Settings Pane: Color (Mac OS 9)	537
Color Settings Pane: Monochrome (Mac OS 9)	540
Media Detailed Settings Dialog Box (Mac OS 9).....	542
Special Settings Dialog Box (Mac OS 9).....	543
View Settings Dialog Box for the Printing Application (Mac OS 9)	544

Network Setting

545

Network Setting	545
Network Environment.....	545
Configuring the IP Address on the Printer	547
Initializing the Network Settings	548
Configuring the Printer's TCP/IP Network Settings	549
Configuring the IP Address Using the Printer Control Panel	551
Configuring the IP Address Using ARP and PING Commands	552
Specifying Printer-Related Information.....	554
Using RemoteUI	555
Email Notification When Printing is Finished or Errors Occur	556
Network Setting (Windows)	557
Configuring the Printer's NetWare Network Settings.....	557
Specifying the Printer's Frame Type.....	559
Specifying NetWare Print Services.....	561
Specifying NetWare Protocols.....	564
Configuring NetWare Network Settings.....	566
Configuring the Printer Driver Destination (Windows).....	567

Sharing the Printer in Windows	568
Installing imagePROGRAF Device Setup Utility	570
Configuring the IP Address Using imagePROGRAF Device Setup Utility	571
Network Setting (Macintosh)	572
Configuring the Printer's AppleTalk Network Settings	572
Configuring the Printer Driver Destination (Macintosh)	573
Configuring the Destination for AppleTalk Network (Macintosh)	574
Configuring the Destination for TCP/IP Network (Macintosh)	578
Configuring the Destination for Bonjour Network (Macintosh)	582

Maintenance 584

Adjusting the Printhead	584
Correcting Print Misalignment	584
Adjusting the Printhead Alignment Automatically	584
Adjusting the Printhead Alignment Manually	586
Adjusting the Printhead Height	588
Adjusting the feed amount	589
Adjusting the Feed Amount Automatically	589
Adjusting the Feed Amount Manually	592
Adjusting the Vacuum Strength	595
Adjusting the Measurement Scale for Better Accuracy	596
Adjusting Color on the Trailing Edge of Sheets	598
Color adjustment	600
Using Color Calibration to Adjust Colors	600
Printing in Ideal Colors for Light in the Viewing Environment	603
By selecting color tones on Charts before printing (Windows)	604
Printing in Colors Matching the Measured Ambient Light	608
Accessing the Printer Driver Dialog Box from Applications (Windows)	611
Ink Tanks	613
Ink Tank	613
Replacing Ink Tanks	614
Checking Ink Tank Levels	620
When to Replace Ink Tanks	621
Printheads	622
Printhead	622
Checking the Print Quality	622
Improving the Print Quality	622
Checking for Nozzle Clogging	623
Cleaning the Printhead	624
Replacing the Printhead	625
Maintenance Cartridge	632
Maintenance Cartridge	632
Replacing the Maintenance Cartridge	632
Checking the Remaining Maintenance Cartridge Capacity	637
When to Replace the Maintenance Cartridge	638

Cleaning the Printer	639
Cleaning the Printer Exterior	639
Cleaning Inside the Top Cover	640
Cleaning the Paper Retainer	643
Cleaning Spurs Used in Paper Feeding	644
Cleaning the Printhead	647
Other Maintenance	648
Preparing to Transfer the Printer	648
Updating the Firmware	652

Troubleshooting **653**

Frequently Asked Questions	653
Frequently Asked Questions	653
Specifying Paper in the Printer Driver	655
Printing does not start	656
The Data lamp on the Control Panel does not light up	656
The Printer Does Not Respond Even if Print Jobs are Sent	656
The Display Screen indicates the system is filling with ink	656
Cannot print over a network	657
Cannot connect the printer to the network	657
Configuring the Communication Mode Manually	658
Cannot print over a TCP/IP network	659
Cannot print over AppleTalk or Bonjour networks	660
Cannot print over a NetWare network	661
The printer stops during a print job	662
An error message is shown on the Display Screen	662
The printer ejects blank, unprinted paper	662
Problems with the printing quality	663
Printing is faint	663
Paper rubs against the Printhead	664
The edges of the paper are dirty	665
The surface of the paper is dirty	666
The back side of the paper is dirty	666
Banding in different colors occurs	666
The contrast becomes uneven during printing	667
Colors in printed images are uneven	667
Problems with the printing quality caused by the type of paper	668
Lines are misaligned	668
The length of printed images is inaccurate	668
Documents are printed in monochrome	668
Printed colors are inaccurate	669
Image Edges are Blurred or White Banding Occurs	670
Documents are printed crooked	670
White dots about 1 mm (0.039 in) apart appear on printed documents, in the direction paper is fed	670

Immediately After Borderless Printing, the Trailing Edge Margin is Soiled During Regular Printing	670
Roller marks are left across the trailing edge of paper	671
Line thickness is not uniform (Windows)	671
Installation problems	672
The IEEE 1394 Driver Cannot Be Installed Correctly	672
Removing Installed Printer Drivers	673
Clearing jammed paper	674
Clearing Jammed Roll Paper	674
Clearing Jammed Paper (Paper Feed Slot)	678
Clearing Jammed Paper from the Tray	679
If the Printer makes a strange sound	682
If the Printer Makes a Strange Sound	682
Other problems	683
The printer consumes a lot of ink	683
A message to check the Maintenance Cartridge is not cleared after you replace the Maintenance Cartridge	683
Paper is not cut straight	683
Paper cannot be cut	683
Depression on the leading edge is left	684
Roller marks are left across the trailing edge of paper	684
The printer does not go on	684
Roll paper cannot be inserted into the Paper Feed Slot	684
Cannot Load Sheets	684
Ink level detection	685

Error Message 687

Responding to Messages	687
Responding to Error Messages	687
Error Messages	689
Messages regarding paper	691
Paper Mismatch	691
Paper Type Mismatch	691
Paper Size Mismatch	692
This paper cannot be used	692
Insufficient paper for job	693
Roll printing is selected, but sheets are loaded	694
Roll printing is selected.	694
Sheet printing is selected.	694
Wrong paper feed slot for this paper type.	695
Manual printing is selected, but a roll is loaded	695
Cannot feed paper	695
Borderless printing not possible.	696
Paper loaded askew	697
Paper size not detected	697
Cannot detect paper	698

End of paper feed.....	698
Cannot feed paper.....	698
Paper jam.....	699
Cannot cut paper.....	699
The roll is empty.....	700
Roll feed unit err.....	700
No Roll Feed Unit.....	700
Messages regarding ink.....	701
Ink Level: Check.....	701
No ink tank loaded.....	701
Ink insufficient.....	702
Ink tank is empty.....	703
Ink tank error.....	703
Remaining level of the ink cannot be correctly detected.....	703
Messages regarding printing or adjustment.....	704
Use another paper.....	704
Cannot execute this command. Use other paper.....	704
Cannot print as specified.....	704
Cannot adjust band.....	704
Cannot adjust printhead.....	705
Excessive temperature or humidity.....	705
Cannot calibrate.....	705
Messages regarding printheads.....	706
Cannot adjust printhead.....	706
Cannot adjust band.....	706
x printhead needs cleaning. (x is Left or Right).....	706
PHeads: wrong pos.....	706
Problem with Printhead x (x is L, R, or LR).....	707
x printhead error (x is Left or Right).....	707
Messages regarding the maintenance cartridge.....	708
No maintenance cartridge.....	708
Prepare for maint cart replacement.....	708
No Maintenance Cartridge capacity.....	708
Maintenance cartridge full.....	708
Maintenance cartridge problem.....	708
Other Messages.....	709
GARO Wxxxx (x represents a number).....	709
Top cover is open.....	709
ERROR Exxx-xxxx (x represents a letter or number).....	709
Unknown file.....	709
Prepare for parts replacement.....	709
Parts replacement time has passed.....	709
Multi-sensor error.....	710
Roll feed unit err.....	710
No Roll Feed Unit.....	710
Hardware error. xxxxxxxx-xxxx (x represents a letter or number).....	710



Introduction

How to use this manual

■ ■ ■ About This User Manual

- Symbols

The following symbols are used in this User Manual to indicate safety information and explanations on restrictions or precautions in use.

	Important	Indicates important information that must be followed when using the printer. Be sure to read this information to prevent printer damage or operating errors.
	Caution	Indicates caution items for which operating error poses a risk of injury or damage to equipment or property. To ensure safe use, always follow these precautions.
	Note	Indicates helpful reference information and supplemental information on particular topics.

- Button names and user interface elements

Key and button names on the control panel and user interface elements in software (such as menus and buttons) are indicated as follows in this User Manual.

Control Panel Buttons	Example: Press the OK button.
Control Panel Interface Items and Messages	Example: Head Cleaning is displayed.
Software Interface Items (Menus and Buttons)	Example: Click OK .
Keyboard Keys	Example: Press the Tab key.

- Part Names

Names of printer parts are indicated as follows in this User Manual.

Printer part names	Example: Open the Top Cover .
--------------------	-------------------------------

How to use this manual

- Cross-reference

Other pages or manuals that provide related information are indicated as follows in this User Manual.

Cross-Reference in the Same User Manual	Example: see “Turning the Printer On and Off”. (→P.19) Click the link to jump to the corresponding page.
Cross-Reference in Related Manuals	Example: See the Paper Reference Guide .
Other Cross-Reference	Example: See the printer driver help.

- Figures and software screens

- Figures in this User Manual may be different from the actual appearance of the printer in some cases.
- Screens depicted in this User Manual for the printer driver or other software may be different from the actual screens because of subsequent updates.
- Windows XP screens are used in explanations of Windows operations in this User Manual.

- Trademarks

- Canon, the Canon logo, and imagePROGRAF are trademarks or registered trademarks of Canon Inc.
- Microsoft and Windows are registered trademarks of Microsoft Corporation in the United States and other countries.
- Macintosh is a registered trademark of Apple Inc. in the United States and other countries.
- Other company and product names are trademarks or registered trademarks of their respective owners.

- Copyright

© 2007 Canon Inc.

- Unauthorized reproduction of this User Manual in whole or part is prohibited.

- May we request

Thank you for understanding the following points.

- The information in this User Manual is subject to change without notice.
- We strive to ensure accuracy of information in this User Manual, but if you notice errors or omissions, please contact us.

Viewing Videos of Explanations

To view videos related to topic pages, click the **View Video** button. The video will play in a separate window. This way, you can learn by watching demonstrations of the actual procedures.

Video Requirements: In Windows, Adobe Flash Player must be installed to view the videos.

If it is not installed, download it by clicking the following URL.

<http://www.adobe.com/products/flashplayer/>

Note that this URL is subject to change. If you cannot access this URL, download Adobe Flash Player by visiting the main Adobe website and navigating to the appropriate page.

HTML Version of the Manual for Printing

For your convenience when printing this manual, HTML versions of the sections in “Using the Printer” on the top page are available. All topics in a section are combined in one file for printing. This section describes how to print sections of the manual, using the content of **Printing Procedure** in **Basic Printing Workflow** as an example.

1. On the top page, click **Basic Printing Workflow**.

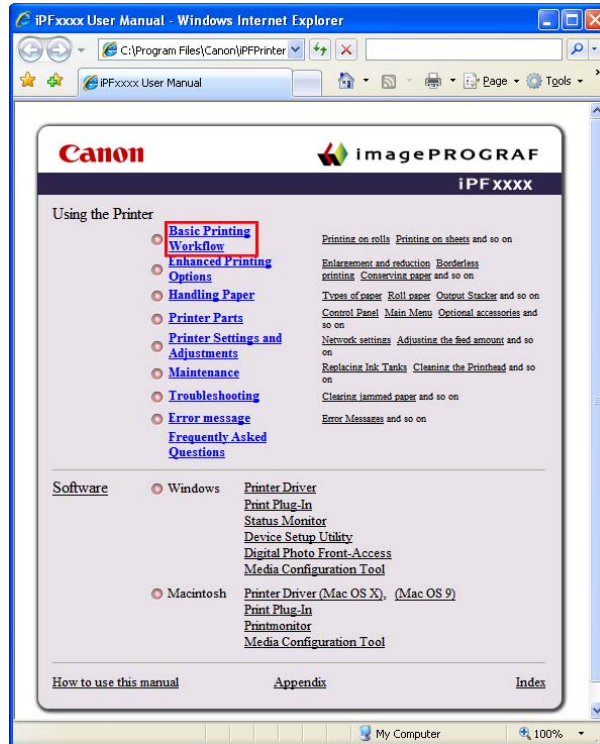

2. Under **Basic Printing Workflow** in the left frame, click **Printing Procedure**.

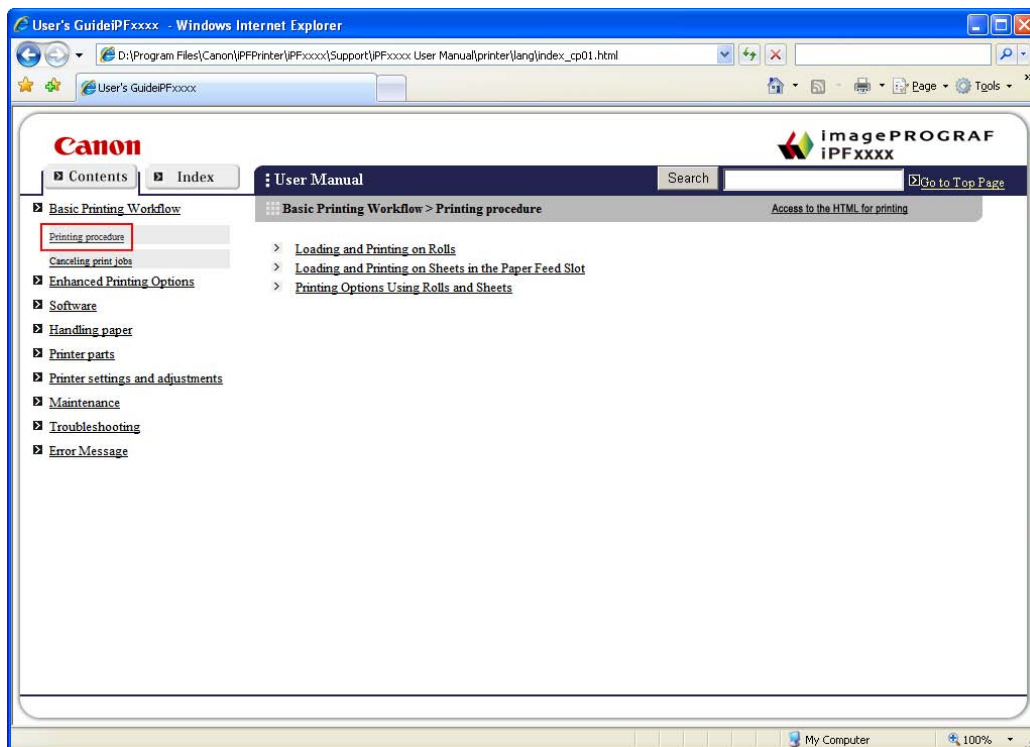

3. In the title area of **Printing Procedure**, click **Access to the HTML for printing**.

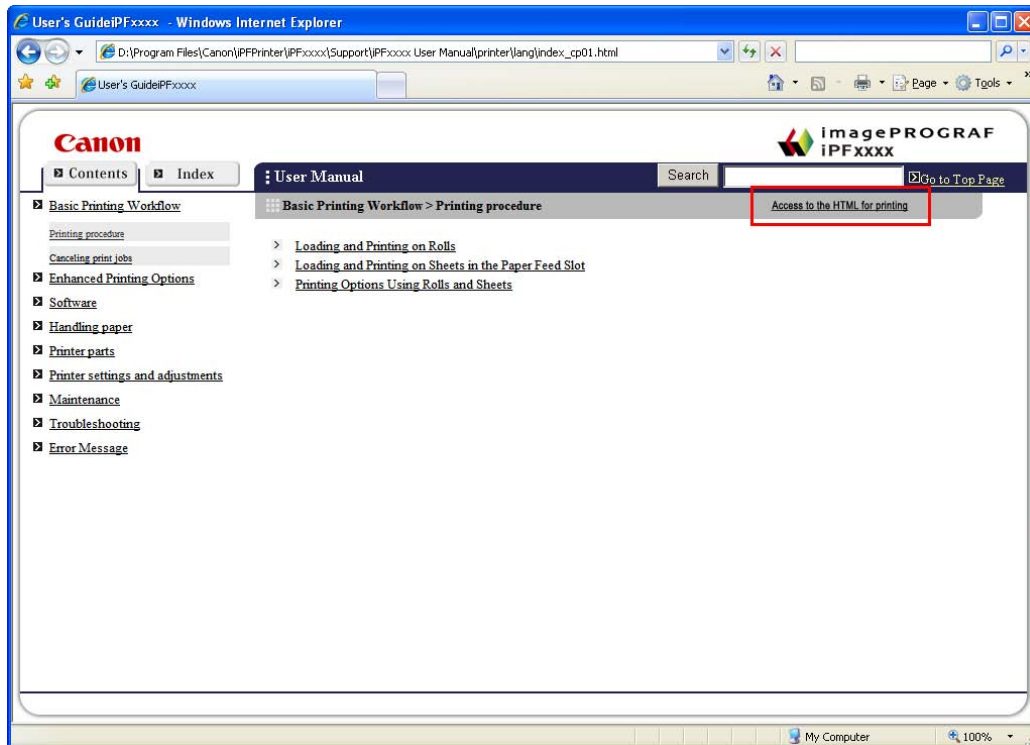

An HTML version of the topics in **Printing Procedure** is displayed, suitable for printing.

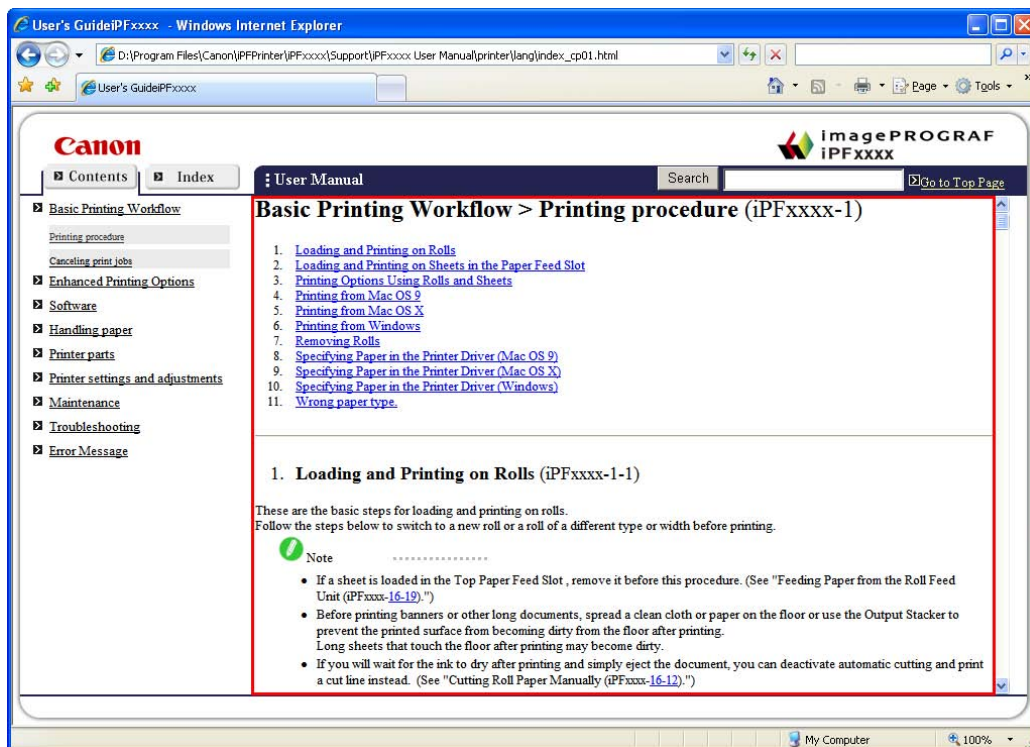

4. Access the printing dialog box as follows, depending on your computer's operating system.

• Windows

In Windows, right-click anywhere in the explanation area except on a figure or a link. In the shortcut menu, click **Print** to display the **Print** dialog box.

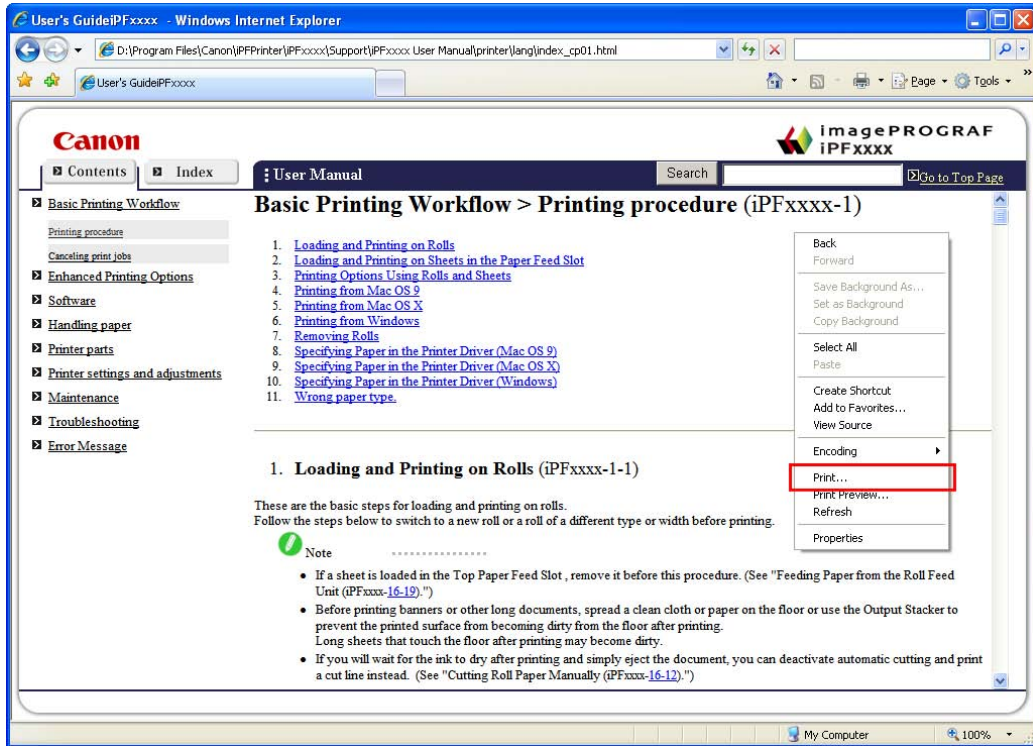

• Macintosh

On a Macintosh computer, click anywhere in the explanation area except on a figure or a link while holding the Ctrl key. In the shortcut menu, click **Print Frame** to display the **Print** dialog box.

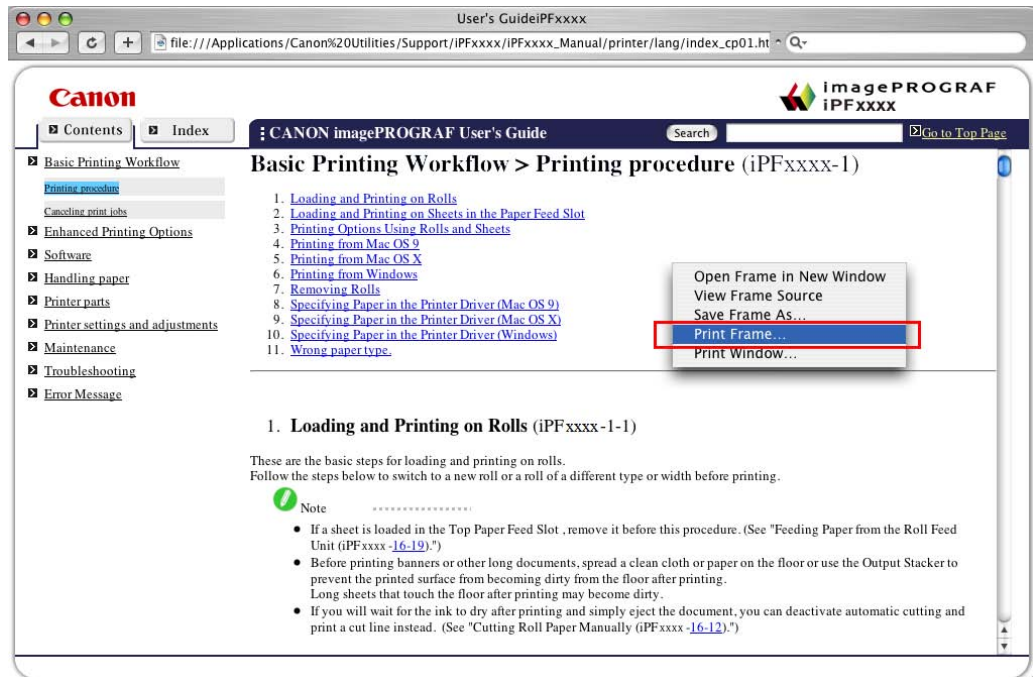

5. Specify conditions as needed, and then click **Print** (Windows) or **Print** (Macintosh).

- Windows

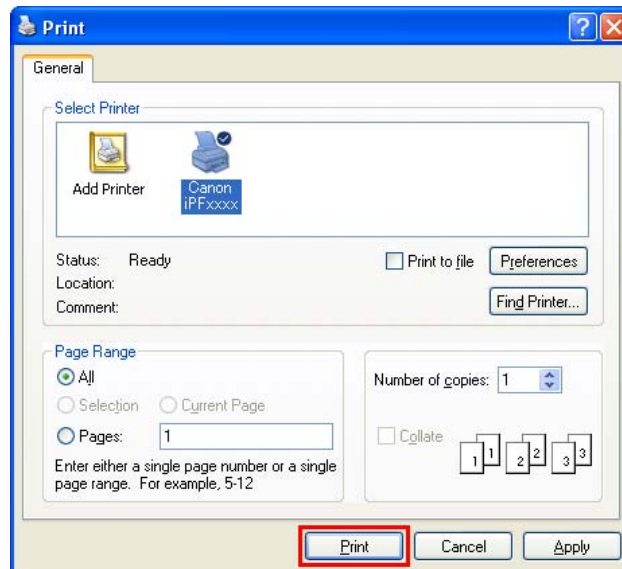

- Macintosh

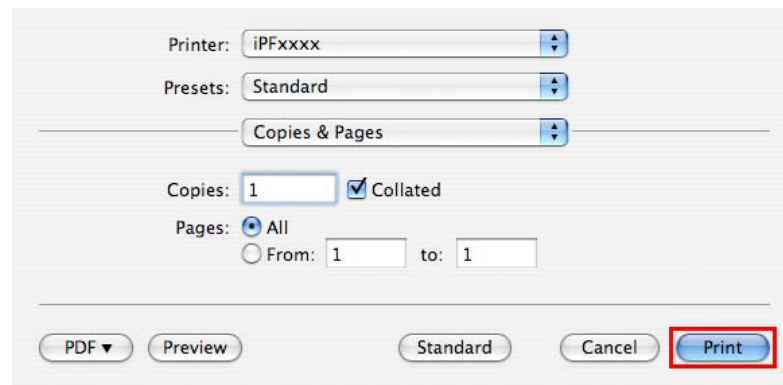

Note

- To print “Software” on the top page or individual topics that are displayed, follow steps 4 and 5.

Printer Parts

Printer parts

Front

Standard

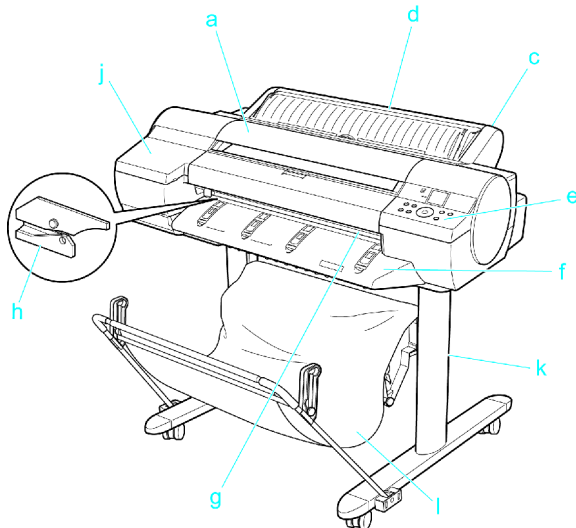

When the Ejection Guide is removed

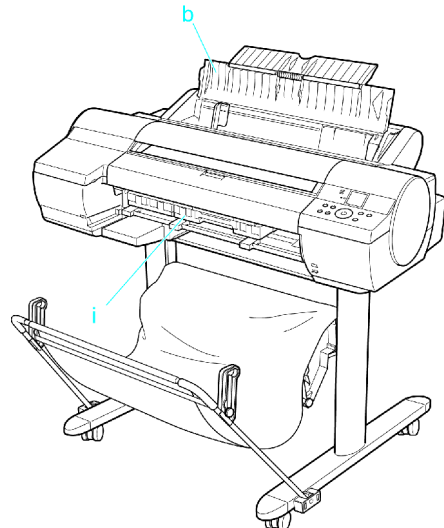

a. Top Cover

Open this cover to install the Printhead and remove any jammed paper from inside the printer, as needed. (→P.10)

b. Paper Tray Cover

Open this cover to load sheets in the Top Paper Feed Slot. (→P.11)

c. Roll Feed Unit

Load rolls in this unit. You can also load sheets in this unit manually.

d. Roll Paper Unit Cover

Open this cover to load rolls. (→P.12)

e. Control Panel

Use this panel to operate the printer and check the printer status. (→P.15)

f. Ejection Guide

Supports paper as it is ejected to prevent it from rising.

g. Output Tray (Front Paper Feed Slot)

All printed documents are ejected to the output tray. Also, use this slot when loading heavyweight paper. (→P.11)

h. Cutter Unit

A round-bladed cutter for automatic cutting of roll paper. The cutter is retracted inside when not cutting.

i. Maintenance Cartridge

Absorbs excess ink.

j. Ink Tank Cover

Open this cover to replace Ink Tank. (→P.14)

k. Stand

A stand on which the printer is installed. Equipped with casters so that the printer can be easily moved.

l. Output Stacker

Printed documents are ejected into the output tray. The Output Stacker (→P.171) can hold one sheet.

Back

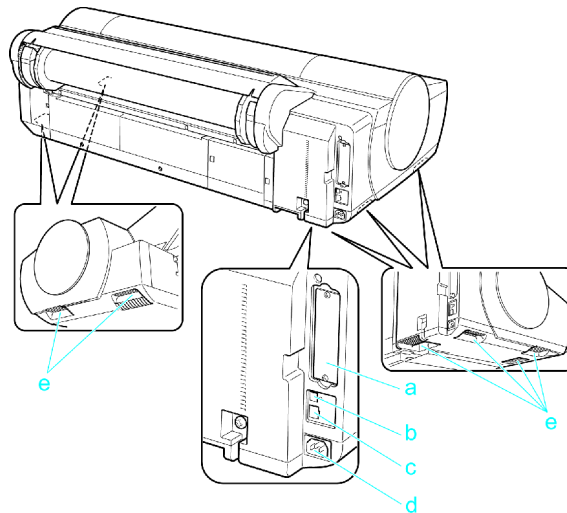

a. Expansion Board Slots

For installing an IEEE 1394 (FireWire) expansion board, as desired.

b. USB Port

Connect a USB cable to this port. This port is compatible with High Speed USB 2.0.

c. Ethernet Port

Connect an Ethernet cable to this port.

d. Power Supply Connector

Connect the power cord to this connector.

e. Carrying handles (at six positions)

When carrying the printer, hold it by these handles under both sides.

☐☐☐ Top Cover (Inside)

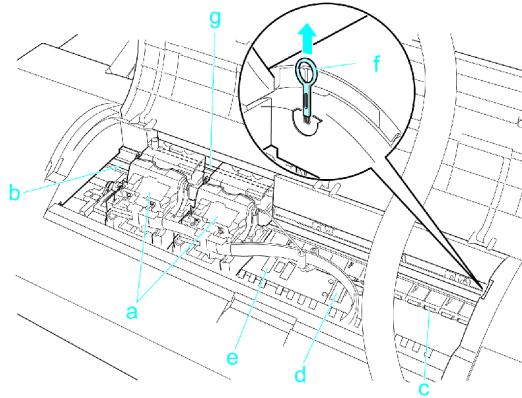

a. Carriage

Moves the Printhead. It serves a key role in printing. (→P.13)

b. Carriage Shaft

The Carriage slides along this shaft.

c. Paper Retainer

Important in supplying the paper. This retainer holds paper as it is fed.

d. Platen

The Printhead moves across the platen during printing. Vacuum holes on the platen hold paper in place.

e. Borderless Printing Ink Grooves

For catching ink outside the edges of paper during borderless printing.

f. Cleaning Brush

When cleaning inside the printer under the Top Cover, use this brush to sweep away paper dust on the Platen.

g. Linear Scale

The linear scale serves a key role in detecting the Carriage position. Be careful not to touch this part when cleaning inside the Top Cover or clearing paper jams.

Tray Feed Area

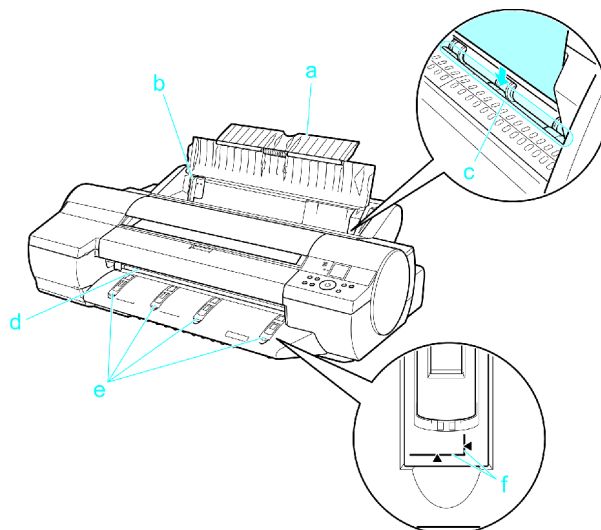

- a. Tray Extension
When loading sheets on the tray, open the Paper Tray Cover before opening the tray.
- b. Width Guide
When loading the sheets, move the guide to match the paper size.
- c. Top Paper Feed Slot
When loading sheets, insert them here.
- d. Front Paper Feed Slot (Output Tray)
When loading heavyweight paper, insert it here. Also, all printed documents are ejected from this slot.
- e. Front Tray Guides
Lift all of the guides before printing on heavyweight paper. When feeding heavyweight paper, rest the sheet on these guides, align it to the right, and insert the leading edge up to the Paper Alignment Line.
- f. Paper Alignment Line
When loading heavyweight paper, ensure the paper edge is parallel to this line.

Roll Paper Unit Cover (Inside)

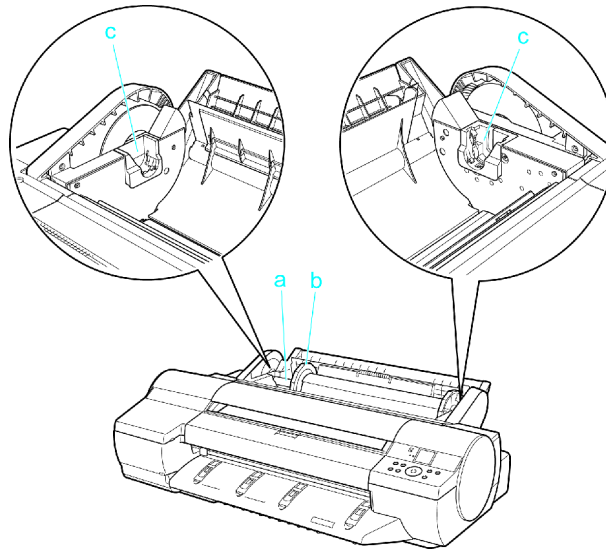

- a. Roll Holder
Load rolls on this holder.
- b. Holder Stopper
Secure rolls on the Roll Holder with this part.
- c. Roll Holder Slot
Slide the Roll Holder into this guide slot.

Carriage

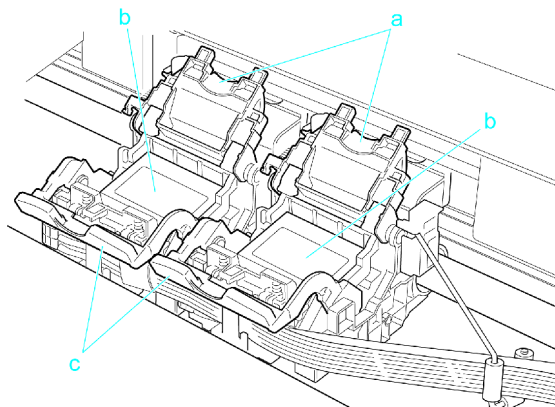

a. Printhead Fixer Cover

Holds the Printhead in place. Do not open this part except during Printhead replacement.

b. Printhead

The printhead is equipped with ink nozzles. It serves a key role in printing.

c. Printhead Fixer Lever

Locks the Printhead Fixer Cover. Do not open this part except during Printhead replacement.

■ Ink Tank Cover (Inside)

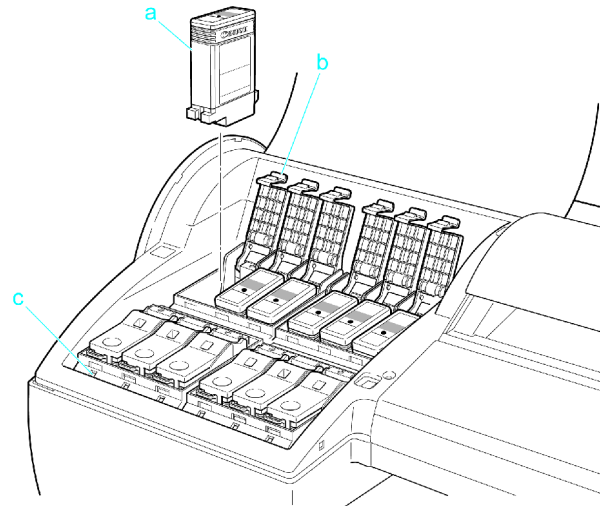

a. Ink Tank

Cartridges of ink in various colors.

b. Ink Tank Lock Lever

A lever that locks the Ink Tank in place and protects it. Open or close the lever when replacing an Ink Tank.

c. Ink Lamp (Red)

Indicates the state of the Ink Tank as follows when the Ink Tank Cover is opened.

- On
On: The Ink Tank is installed correctly.
- Off
Off: No Ink Tank is installed, or the ink level detection function is disabled.
- Flashing Slowly
Not much ink is left.
- Flashing Rapidly
There is no ink left.

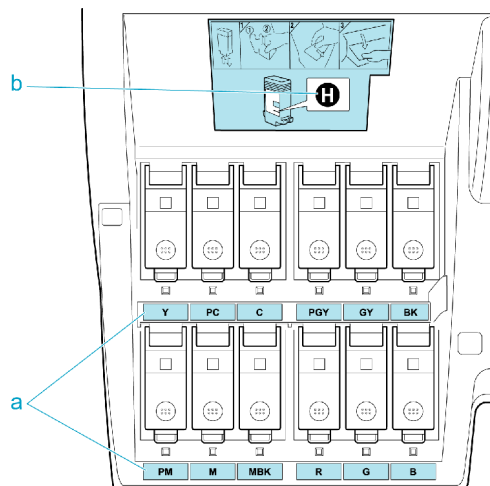

a. Ink Color Label

Load an Ink Tank corresponding to the color and name on these labels.

b. Ink Set

An Ink Tank that can be used in the printer (→P.613) is labeled with a white letter “H” in a black circle on the side. When purchasing an Ink Tank, make sure an “H” is printed on the label.

Control Panel

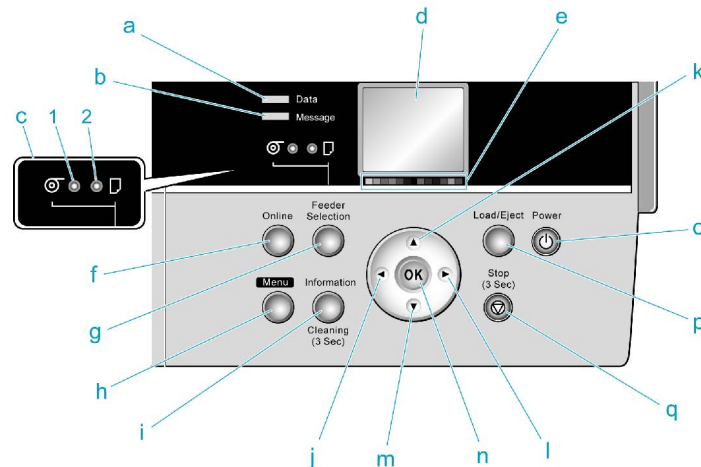

a. Data lamp (Green)

- Flashing
During printing, the Data lamp flashes when the printer is receiving or processing print jobs. Otherwise, this lamp flashes when the printer is paused or updating the firmware.
- Off
There are no active print jobs when the Data lamp is off.

b. Message lamp (Orange)

- On
A warning message is displayed.
- Flashing
An error message is displayed.
- Off
The printer is off or is operating normally.

c. Paper Source Section

After you press the **Feeder Selection** button, the lamp for your chosen paper source is lit.

1. Roll Media lamp (Green) (Rolls)

- On
Indicates that a roll is selected as the paper source.
- Off
Shows whether the Tray or Front Paper Feed Slot is selected as the paper source.

2. Cut Sheet lamp (Green)

- On
Shows whether the Tray or Front Paper Feed Slot is selected as the paper source.
- Off
Indicates that a roll is selected as the paper source.

d. Display Screen

Shows the printer menu, as well as the printer status and messages.

e. Color Label

These labels indicate the Ink Tank colors and names. The labels correspond to the ink levels on the Display Screen.

f. **Online** Button

Switches the printer online and offline. (→P.26)

- On (Green)
The printer is online.
- Flashing
The printer is recovering from Sleep mode.
- Off
The printer is offline.

g. **Feeder Selection** Button

Switches the paper source. Each time you press this button, the paper source switches between roll feed (when the paper source is a roll) and sheet feed (when the paper source is the Tray or Front Paper Feed Slot). The corresponding lamp in the paper source section is lit.

h. **Menu** Button

Displays the main menu of the printer. (→P.49)

i. **Information** Button

Displays printer submenus. Press this key to display information about ink, paper, and so on. (→P.61)

You can also hold down this button for three seconds to clean the Printhead (**Head Cleaning A**).

j. ◀ Button

Menu mode: Press this button to display the menu one level higher.

When you are entering numbers, the button moves the cursor to the next digit.

The instructions can be paused when [← **Pause**] is displayed.

When [← **Back**] is displayed, you can access the previous instruction screen.

k. ▲ Button

Offline mode: Press this button to rewind rolls manually. (→P.126)

Menu mode: Press this button to display the previous menu item or setting value.

l. ▶ Button

Menu mode: Press this button to display the menu one level lower.

When [**Fwd** →] is displayed, you can access the next instruction screen.

m. ▼ Button

Offline mode: Press this button to feed roll paper manually. (→P.126)

Menu mode: Press this button to display the next menu item or setting value.

n. **OK** Button

In menu mode, press this button to confirm or execute the selected item or setting.

At other times, pressing this button enables you to access the next screen after following the instructions on the Display Screen.

o. **Power** Button

Turns the printer on and off. (→P.19)

p. **Load/Eject** Button

You can check instructions on loading, replacing, and removing paper. Instructions for loading or replacing paper are shown on the Display Screen if pressed when no paper is loaded, and instructions for removing paper are shown if paper is loaded.

q. Stop Button

Hold down for at least a second to cancel print jobs in progress or end the ink drying period.

During display of instructions on loading sheets, for example, you can hold down this button for one second to pause the current screen.

**Note**

- When the printer is in Sleep mode, you can press any button to wake the printer and bring it online or offline again.

Vents

The vents are on top (1), on the right (2), and on the bottom on the right (3 and 4).

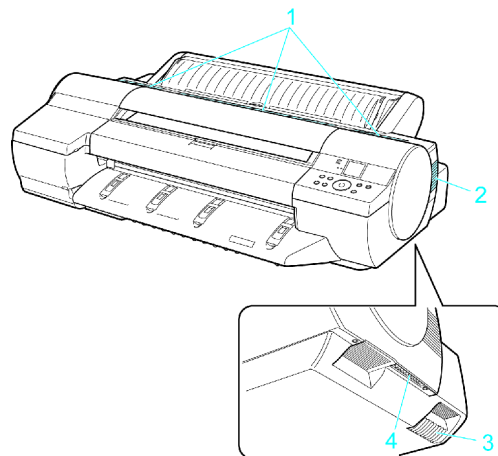

Caution

- Do not block these vents when the printer is on.
- Avoid setting paper or other light objects near the vents.

Control Panel

Turning the Printer On and Off

Turning the printer on

1. Press the **Power** button to turn on the printer.

The printer will now start up.

After the Display Screen shows the Canon logo, **Starting up... Please wait.** is displayed.

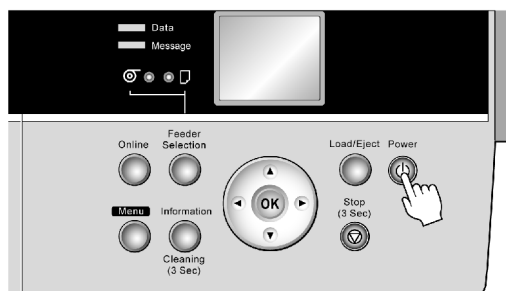

2. The printer goes online in preparation for printing after startup, and the Online lamp and paper source section lamp remain lit.

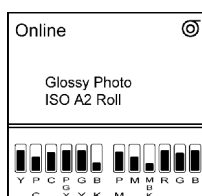
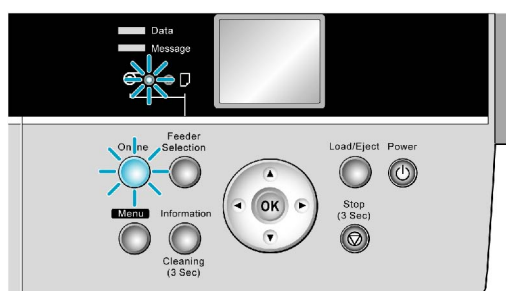

The printer will not go online in the following situations. Take action as needed.

- The Top Cover is open
Close the Top Cover.
- The Ink Tank Cover is open
Close the Ink Tank Cover.
- The Printhead is not installed
Please see "Replacing the Printhead". (→P.625)
- Ink Tank is not installed
Please see "Replacing Ink Tanks". (→P.614)
- "ERROR" is shown on the Display Screen
Turn off the printer and contact your Canon dealer.
- The Online lamp and **Message lamp** are not lit (even once), and nothing appears on the Display Screen
Make sure the printer is plugged in correctly. Check the connection at the plug and electrical outlet.

- No paper is loaded
Load paper. (→P.80) (→P.85)



Important

- Starting the printer when it is connected via the USB cable to a Macintosh computer that is off may cause the computer to start up at the same time. To prevent this, disconnect the USB cable before starting the printer. Connecting the printer to the computer via a USB hub may solve this issue.

Turning the printer off



Important

- Never turn the printer off or unplug it during a print job. This could damage the printer.

1. Make sure no print jobs are in progress.

If the **Message lamp** is flashing, check the message on the Display Screen and take action as necessary. (→P.689)

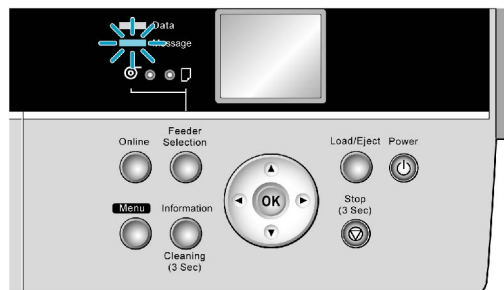

If the **Data lamp** is flashing, the printer is receiving a print job. Turn off the printer only after printing is finished.

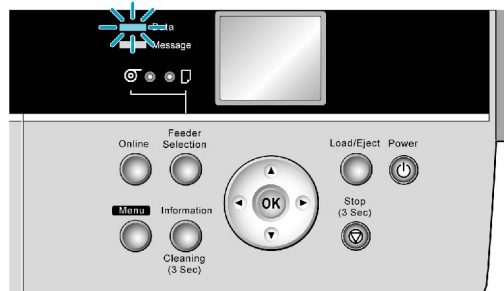

2. Hold down the **Power** button for more than a second.

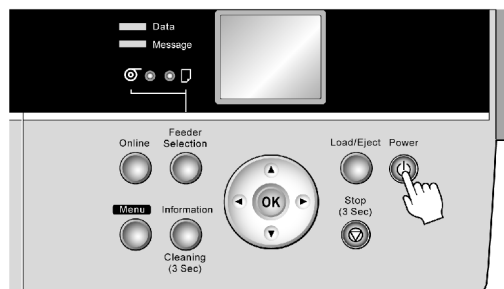

After **Shut Down.. Please Wait..** is shown on the Display Screen, the printer shuts off.

Printer Modes

Printer modes are classified as follows and described in this topic.

- Modes (→P.21)
- Mode transition (→P.22)
- Online, and state of the Control Panel (→P.23)
- Offline, and state of the Control Panel (→P.24)
- Menu mode, and state of the Control Panel (→P.25)
- Submenu mode, and state of the Control Panel (→P.25)

Modes

The printer has five modes as follows:

- Online
The printer is ready to receive jobs sent from the computer. Jobs sent from the computer are processed immediately. If jobs are received in other modes, they are printed the next time the printer goes online.
- Offline
Any jobs sent from the computer are held without being processed.
While the printer is offline, you can feed or cut roll paper manually.
The printer goes offline automatically if jobs cannot be processed, such as if errors occur.
- Menu mode
Menus are displayed on the printer, and you can select, set, or execute menu items. Any jobs sent from the computer are held without being printed.
- Submenus
Submenus are displayed regarding ink and paper information. Jobs can be received and printing is possible while submenus are displayed and the printer is online. In other modes, any jobs sent from the computer are held without being printed while submenus are displayed.
- Sleep mode
The printer is in power-saving mode. The printer automatically enters Sleep mode to conserve power if it is idle for a specific period (by factory default, five minutes), that is, if no print jobs are received or buttons are pressed while all covers are closed.
You can specify the period before the printer enters Sleep mode in the **Sleep Timer** menu. (→P.49)
If any print jobs are received when the printer is in Sleep mode (after it was originally online), the printer goes online and prints the jobs.

Online, and state of the Control Panel

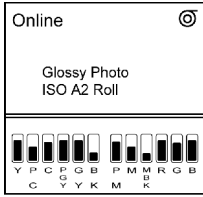
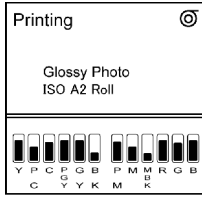

Not printing	Printing in progress (receiving or processing print jobs)
	
<p>Display Screen</p> <ul style="list-style-type: none"> • Top Level of the Display Screen The printer status is displayed here. The selected paper source is indicated by an icon in the upper-right corner. Any warning messages are displayed here on lines 2-4. Take action as needed. (→P.689) • Middle Level of the Display Screen The first and second lines display the paper type and size. • Bottom Level of the Display Screen Here, the remaining ink level is indicated. (→P.620) <p>Control Panel</p> <ul style="list-style-type: none"> • Online lamp (→P.15) Lit when the printer is online. • Data lamp (→P.15) Flashes when print jobs are being received or processed. • Message lamp (→P.15) Lit when warning messages are displayed. 	

Offline, and state of the Control Panel

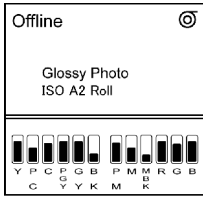
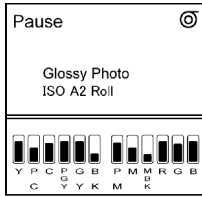
Offline

Not printing	Printing is paused
	
<p>Display Screen</p> <ul style="list-style-type: none"> • Display Screen The printer status is displayed here. The selected paper source is indicated by an icon in the upper-right corner. Any warning messages are displayed here on lines 2-4. Take action as needed. (→P.689) • Middle Level of the Display Screen The first and second lines display the paper type and size. • Bottom Level of the Display Screen Here, the remaining ink level is indicated. (→P.620) <p>Control Panel</p> <ul style="list-style-type: none"> • Message lamp (→P.15) Lit when warning messages are displayed. 	

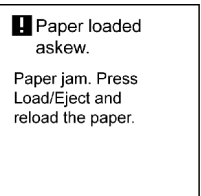
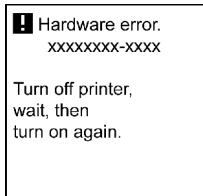

Error Messages

If action can be taken		If no action can be taken	
			
<ul style="list-style-type: none"> • Top and Middle Levels of the Display Screen Error messages are displayed. • Bottom Level of the Display Screen Here, the remaining ink level is indicated. (→P.620) 	<ul style="list-style-type: none"> • Top and Middle Levels of the Display Screen Error messages are displayed. • Bottom Level of the Display Screen The corrective actions are displayed here. 	<ul style="list-style-type: none"> • Top and Middle Levels of the Display Screen The error message is displayed with the following instructions: Turn off printer, wait, then turn on again. 	<ul style="list-style-type: none"> • Display Screen “ERROR” is displayed, followed by the error code and Call for service.
<ul style="list-style-type: none"> • Data lamp (→P.15) Flashes when print jobs are being received. • Message lamp (→P.15) Flashes when error messages are displayed. 		<ul style="list-style-type: none"> • Data lamp (→P.15) Flashes when print jobs are being received. • Message lamp (→P.15) Flashes when error messages are displayed. 	
<p>Take action as needed. (→P.689)</p>		<p>Turn off the printer and wait at least three seconds before restoring the power. If the message is still displayed after this, write down the error code and message, turn off the printer, and contact the Canon dealer for assistance.</p>	

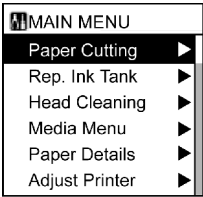
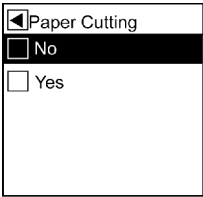
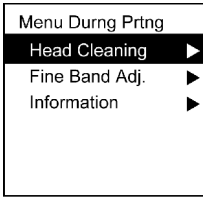
Menu mode, and state of the Control Panel

Main menu	Menu items and settings	Main menu (during printing)
		
<ul style="list-style-type: none"> • Display Screen Pressing the Menu button when printing is not in progress displays the main menu. The title of the selected menu is displayed on the first line, and items in this menu are displayed on the second and subsequent lines. If a scroll bar is shown at right, the menu is continued below but cannot be displayed all at once. (→P.30) 	<ul style="list-style-type: none"> • Display Screen The title of the selected menu is displayed on the first line, and menu items or settings are displayed on the second and subsequent lines. (→P.30) The menu of options available during printing (top figure) can be displayed by pressing the ▶ button when the main menu is displayed (left figure). 	<ul style="list-style-type: none"> • Display Screen The menu of options that are available during printing can be displayed while you are printing by pressing the Online button to pause printing and then pressing the Menu button. When you select a menu, the title of the selected menu is displayed on the first line and items in the menu are displayed on the second and subsequent lines. If a scroll bar is shown at right, the menu is continued below but cannot be displayed all at once. (→P.30)

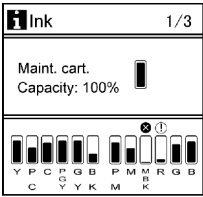
Submenu mode, and state of the Control Panel

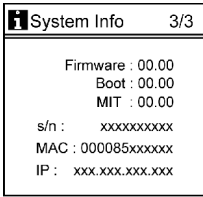
Remaining Maintenance Cartridge capacity and ink levels	Information of the loaded paper	Printer information
		
<p>Press the Information button to display this information, one after another: the Maintenance Cartridge capacity and remaining ink levels, paper information, and printer information. (→P.61)</p>		

Switching Modes

Switching the Printer Online/Offline

Press the **Online** button to switch the printer online or offline.

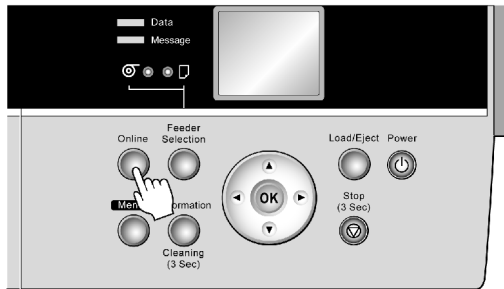

The Online lamp is lit in Online mode. Printing is possible in this mode.

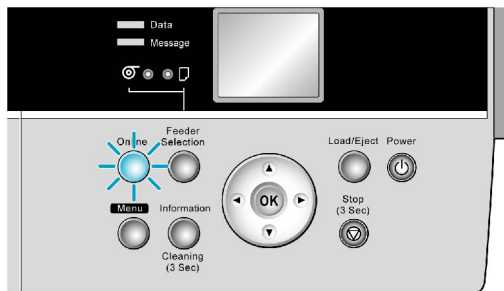

The Online lamp is off in Offline mode.

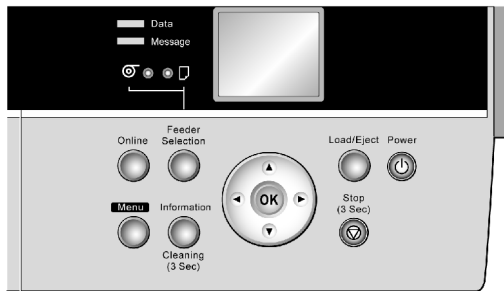

Depending on the status, the printer switches online and offline as follows.

Printer Status	When the Online Button is Pressed
Online	The printer switches offline and the Online lamp goes off.
Online, printing	Switches offline and printing is paused. When printing is paused, the Printing menu is available.
Offline	Switches online and the Online lamp is lit.
Offline, when an error message is displayed	In the case of error messages other than those shown below or if paper is not loaded, the printer remains offline until you solve the problem. The Online lamp remains off.
	If the following error messages are displayed, the printer switches online and printing is resumed. However, you may not be able to obtain the desired printing results. <ul style="list-style-type: none"> • Insufficient paper for job • PHead needs cleaning. • PapR Size Mismatch • PapR Type Mismatch
Menu mode	Switches online and the Online lamp is lit.
Menu mode, printing	Switches online and the Online lamp is lit. Printing is resumed.

Switching to Menu Mode

Press the **Menu** button to display the main menu.

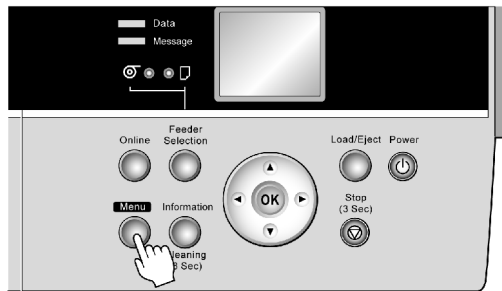

Depending on the status, the printer switches to Menu mode as follows.

Printer Status	When the Menu Button is Pressed
Online	Switches to Menu mode.
Online, printing	The printer stays online. It does not switch to Menu mode.
Offline	Switches to Menu mode.
Offline, printing	Menus available during printing are displayed.
Offline, when an error message is displayed	Not switch to Menu mode until the problem is solved.

Press the **Information** button to display the submenus.

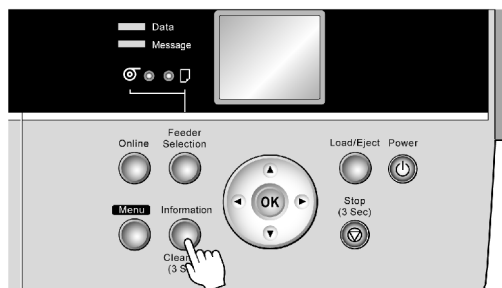

Press the **Information** button to display the Maintenance Cartridge capacity and remaining ink levels, as well as information on the loaded paper and the printer. Press the **Information** button repeatedly to change the information displayed. (→P.61)

Press any button other than the **Information** button to restore the previous mode.

After you display a submenu, the printer will revert to the previous mode in about ten seconds if no print job is received or if you do not operate the printer.



Note

- You can start **Head Cleaning A** by holding down the **Information** button for three seconds or more. (→P.624)

Printer Menu Operations

For instructions on selecting menu items, see “Main Menu Operations”. (→P.30)

For details on menu levels and menu items, see “Menu Structure”. (→P.35)

The printer menu structure is made up of a main menu and submenus.

Access the main menu by pressing the **Menu** button on the Control Panel. The principal settings available in the main menu are as follows:

- Paper Settings
Specify the type and size of paper.
- Print Settings
Adjust or clean the Printhead, or adjust the paper feed amount.
- Printer Settings
Configure the network settings, set the sleep timer, and specify the unit of measurement on the display.



Note

- By default, main menu settings apply to all print jobs. However, for settings that are also available in the printer driver, the values specified in the printer driver take priority.

Access the submenu by pressing the **Information** button on the Control Panel. You can check the following information in submenus.

- Ink levels
- Maintenance Cartridge capacity
- Size and type of paper that is selected
- Amount of roll paper left

☰ Main Menu Operations

Press the **Menu** button to display the main menu. For details, see “Main Menu Settings”. (→P.49)

- Main menu when no print job is in progress

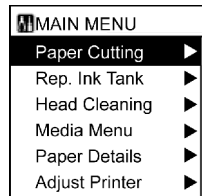

- Main menu during printing

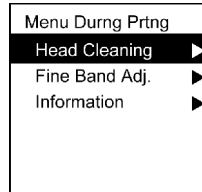

Note

- The main menu will not be displayed in the following cases even if you press the **Menu** button.
 - An error message is displayed
You can access the Menu mode after you have solved the problem.
- Pressing the **Menu** button when printing is paused (because you have pressed the **Online** button) displays main menu items that are available during printing.

To access each function menu from the main menu, and set or execute menu items, use buttons on the Control Panel.

The following section describes menu operations and how they are presented in this **User Manual**.

- Accessing Menus (→P.31)
- Specifying menu items (→P.32)
- Specifying numerical values (→P.33)
- Executing menu commands (→P.34)

Accessing Menus

Printer menus are grouped by function.

Menus are displayed with the upper line selected. Use the buttons on the Control Panel to access each menu.

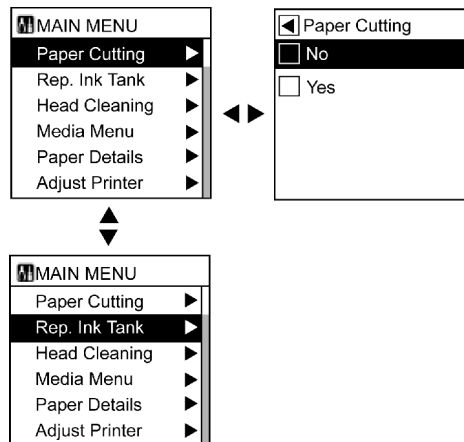

- Press ▲ to access a higher menu in the menu list, and press ▼ to access a lower one. If items of the menu list are more than the lines of the screen, press ▲ and ▼ to scroll the menu. If you navigate to the lowest-level menu and press the ▼ button again, the display switches to the top-level menu screen. If you navigate to the top-level menu and press the ▲ button again, the display switches to the lowest-level menu screen. Items you select are highlighted.

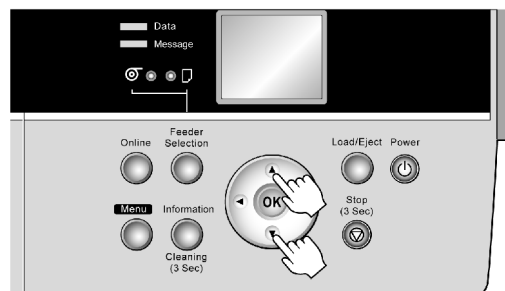

The scroll bar at right indicates the current position in the overall menu.

- To access these lower level menus, select a menu and press ▶.
- To return to upper level menus, press the ◀ button.

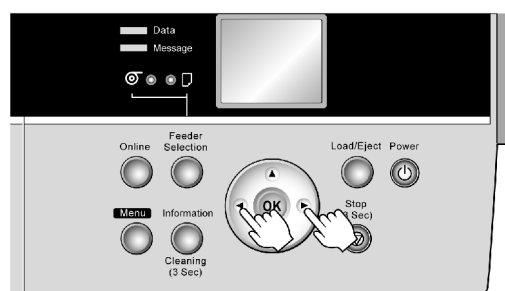

Specifying menu items

Follow the steps below to specify menu items.

1. Press ▲ or ▼ to select a menu, and then press the ► button.
Repeat these steps until the desired menu options are displayed.
2. Press ▲ or ▼ to select the desired setting, and then press the **OK** button.
The check box at left is selected, and the setting is confirmed.

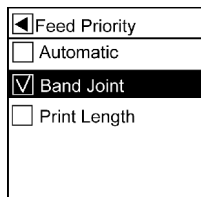
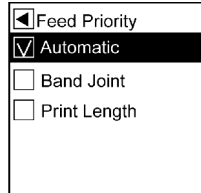

After two seconds, the display reverts to the upper level menu.

3. Press the **Online** button to bring the printer online.



Note

- If a confirmation message is displayed regarding the setting you entered, press the **OK** button. The setting is applied, and the printer goes online.

Specifying numerical values

Follow the steps below to enter numbers for items such as network settings.

1. Press ▲ or ▼ to select **Interface Setup**, and then press the ► button.
2. Press ▲ or ▼ to select **TCP/IP**, and then press the ► button.
3. Press ▲ or ▼ to select **IP Setting**, and then press the ► button.
4. Press ▲ or ▼ to select **IP Address**, and then press the ► button.
5. Press ◀ or ▶ to move the cursor () to each field for entering numbers.

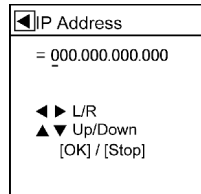

6. Press ▲ or ▼ to select the number, and then press the **OK** button.



Note

- Hold down ▲ or ▼ to increase or decrease the value continuously.
- Make sure the IP address you enter for the printer is not the same as any computer IP address in your network.

7. Repeat steps 2 and 3 to continue entering numbers.
8. Press the **Online** button to bring the printer online.



Note

- If a confirmation message is displayed regarding the setting you entered, press the **OK** button. The setting is applied, and the printer goes online.

Executing menu commands

Follow the steps below to execute menu commands.

1. Press ▲ or ▼ to select a menu, and then press the ► button.
Repeat these steps until the desired menu options are displayed.
2. Press ▲ or ▼ to select the action to execute, and then press the **OK** button.

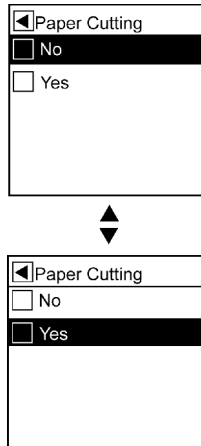

After two seconds, the menu command is executed. After commands are executed, the printer commonly reverts to the state before the menu operation, either online or offline.

Menu Structure

Main Menu

The structure of the main menu is as follows. Values at right indicated by an asterisk "*" are the defaults.

For instructions on menu operations, see "Main Menu Operations". (→P.30)

For details on menu items, see "Main Menu Settings". (→P.49)

First Level	Second Level	Third Level	Fourth Level	Fifth Level
Paper Cutting (*1)	No *			
	Yes			
Rep. Ink Tank	No *			
	Yes			
Head Cleaning	Head Cleaning A			
	Head Cleaning B			
Media Menu	Manual PaperType	Plain Paper (*5)		
		Plain Paper HQ (*5)		
		Plain Paper HG (*5)		
		Recycled Coated (*5)		
		High Resolution (*5)		
		Coated Paper (*5)		
		HW Coated (*5)		
		Ex HW Coated (*5)		
		Premium MatteP (*5)		
		Matte Photo (*5)		
		Glossy Photo (*5)		
		Semi-GI Photo (*5)		
		HW GlossyPhoto2 (*5)		
		HW SemiGIPhoto2 (*5)		
		Poster Semi-GI (*5)		
		SatinPhoto 190 (*5)		
		Photo PaperPlus (*5)		

Control Panel

First Level	Second Level	Third Level	Fourth Level	Fifth Level
		PhotoPlusSemiGI (*5)		
		Syn. Paper (*5)		
		Adh. Syn. Paper (*5)		
		Backlit Film (*5)		
		Backprint Film (*5)		
		Flame-Res.Cloth (*5)		
		ThinFab.Banner2 (*5)		
		Proofing Paper (*5)		
		News Proof 1 (*5)		
		News Proof 2 (*5)		
		FineArt Photo (*5)		
		FneArt HW Photo (*5)		
		FineArt Txtr (*5)		
		FineArt Wtrclr (*5)		
		FineArtBlockP (*5)		
		Canvas Matte2 (*5)		
		JPN Paper Washi (*5)		
		Colored Coated (*5)		
		CAD Trace Paper (*5)		
		CAD Matte Film (*5)		
		POP Board (*5)		
		Special # Here, the number is 1-10 (*5)		
	Manual PaperSize	ISO A1		
		ISO A2+		
		ISO A2		
		ISO A3+		
		ISO A3		

First Level	Second Level	Third Level	Fourth Level	Fifth Level
		ISO A4		
		ISO B2		
		ISO B3		
		ISO B4		
		JIS B2		
		JIS B3		
		JIS B4		
		22"x34"(ANSI D)		
		17"x22"(ANSI C)		
		11"x17" (Ledger)		
		13"x19" (Super B)		
		Letter (8.5"x11")		
		Legal (8.5"x14")		
		24"x36" (ARCH D)		
		18"x24" (ARCH C)		
		12"x18" (ARCH B)		
		9"x12" (ARCH A)		
		DIN C2		
		DIN C3		
		DIN C4		
		20"x24"		
		18"x22"		
		14"x17"		
		12"x16"		
		10"x12"		
		10"x15"		
		8"x10"		
		16"x20"		
		20"x30"		
		13"x22"		
		300x900mm		
		Free Size Setng		
	Roll Media Type (*1)	Plain Paper (*5)		
		Plain Paper HQ (*5)		

Control Panel

First Level	Second Level	Third Level	Fourth Level	Fifth Level
		Plain Paper HG (*5)		
		Recycled Coated (*5)		
		Coated Paper (*5)		
		HW Coated (*5)		
		Ex HW Coated (*5)		
		Premium MatteP (*5)		
		Glossy Photo (*5)		
		Semi-GI Photo (*5)		
		HW GlossyPhoto2 (*5)		
		HW SemiGIPhoto2 (*5)		
		Poster Semi-GI (*5)		
		SatinPhoto 190 (*5)		
		Syn. Paper (*5)		
		Adh. Syn. Paper (*5)		
		Backlit Film (*5)		
		Backprint Film (*5)		
		Flame-Res.Cloth (*5)		
		ThinFab.Banner2 (*5)		
		Proofing Paper (*5)		
		News Proof 1 (*5)		
		News Proof 2 (*5)		
		FineArt Photo (*5)		
		FneArt HW Photo (*5)		
		FineArt Txtr (*5)		
		FineArt Wtrclr (*5)		
		FineArtBlockP (*5)		
		Canvas Matte2 (*5)		

First Level	Second Level	Third Level	Fourth Level	Fifth Level
		JPN Paper Washi (*5)		
		Colored Coated (*5)		
		CAD Trace Paper (*5)		
		CAD Matte Film (*5)		
		Special # Here, the number is 1-10 (*5)		
	Chk Remain.Roll	Off *		
		On		
	Roll Length Set (*1, *2)	### m (*11)		
		### feet (*11)		
Paper Details	(The paper type is displayed here.) (*5)	Roll DryingTime	Off	
			30 sec.	
			1 min.	
			3 min.	
			5 min.	
			10 min.	
			30 min.	
			60 min.	
		Scan Wait Time	Off	
			1 sec.	
			3 sec.	
			5 sec.	
			7 sec.	
			9 sec.	
		Feed Priority	Automatic *	
			Band Joint	
			Print Length	
		Adjust Length	From -0.70% to 0.70%	
		Head Height	Automatic *	
			Highest	
			High	

Control Panel

First Level	Second Level	Third Level	Fourth Level	Fifth Level
			Standard	
			Low	
			Lowest	
		Skew Check Lv.	High Accuracy	
			Standard *	
			Loose	
			Off	
		VacuumStrngth	Automatic *	
			Strongest	
			Strong	
			Standard	
			Weak	
			Weakest	
		NearEnd RollMrgn	3mm	
			20mm	
		Cut Speed	Fast	
			Standard	
			Slow	
		Trim Edge First	Automatic	
			Off	
			On	
		Cutting Mode	Automatic	
			Eject	
			Manual	
		Bordless Margin	Automatic	
			Fixed	
		CutDustReduct.	On	
			Off	
		NearEnd Sht Mrgn	3mm	
			20mm	
		Manual Feed	Front	
			Top	
		Return Defaults (*12)	No	
			Yes	

First Level	Second Level	Third Level	Fourth Level	Fifth Level
Adjust Printer	Auto Head Adj.	Standard Adj.	No	
			Yes	
		Advanced Adj.	No	
			Yes	
		Auto Print	Off	
			On *	
	Manual Head Adj (*9)	No		
		Yes		
	Auto Band Adj.	Standard Adj.	No	
			Yes	
		Advanced Adj.	No	
			Yes	
	Manual Band Adj	No		
		Yes		
	Adj Far Ed Feed	No		
		Yes		
	Adjust Length (*3)	No		
		Yes		
	Calibration	Auto Adjust	No	
			Yes	
		Calibration Log	Date	
			Paper Type	
		Use Adj. Value	Disabled	
			Enabled *	
		Return Defaults	No	
			Yes *	
Interface Setup	EOP Timer	10 sec.		
		30 sec.		
		1 min.		
		2 min.		
		5 min.		
		10 min. *		
		30 min.		
		60 min.		

Control Panel

First Level	Second Level	Third Level	Fourth Level	Fifth Level
	TCP/IP	IP Mode	Automatic	
			Manual *	
		Protocol (*4)	DHCP	On
				Off *
			BOOTP	On
				Off *
			RARP	On
				Off *
		IP Setting (*10)	IP Address	0.0.0.0 - 255.255.255.255
			Subnet Mask	0.0.0.0 - 255.255.255.255
			Default G/W	0.0.0.0 - 255.255.255.255
	NetWare	NetWare	On	
			Off *	
		Frame Type (*6)	Auto Detect	
			Ethernet 2	
			Ethernet 802.2 *	
			Ethernet 802.3	
			Ethernet SNAP	
		Print Service (*6)	BinderyPServer	
			RPrinter	
			NDSPServer *	
			NPrinter	
	AppleTalk	On		
		Off *		
	Ethernet Driver	Auto Detect	On *	
			Off	
		Comm.Mode (*7)	Half Duplex *	
			Full Duplex	
		Ethernet Type (*7)	10 Base-T *	
			100 Base-TX	
		Spanning Tree	Not Use *	
			Use	
		MAC Address	000085 XXXXXX	

First Level	Second Level	Third Level	Fourth Level	Fifth Level
	Ext. Interface	No		
		IEEE1394		
	Return Defaults	No		
		Yes		
Maintenance	Repl. maint cart	No		
		Yes		
	Replace P.head	Printhead L	No	
			Yes	
		Printhead R	No	
			Yes	
	Move Printer	No *		
		Yes		
	Clean Platen	No		
		Yes		
	Spur Cleaning	No		
		Yes		
System Setup	Warning	Buzzer	Off	
			On *	
		Detect Mismatch	Pause	
			Warning	
			None *	
	Keep Media Size	Off *		
		On		
	Paper Size Basis	Sht Selection	ISO A3+ *	
			13"x19"(Super B)	
		Roll Selection 1	ISO A3 (297mm) *	
			300mm Roll	
		Roll Selection 2	10in. (254mm) *	
			JIS B4 (257mm)	
	TrimEdge Reload	Automatic		
		Off *		
		On		
	Noz. Check Freq.	Off		
		1 page		
		10 pages		

First Level	Second Level	Third Level	Fourth Level	Fifth Level
		Automatic *		
	Sleep Timer	5 min. *		
		10 min.		
		15 min.		
		20 min.		
		30 min.		
		40 min.		
		50 min.		
		60 min.		
		240 min.		
	Length Unit	meter *		
		feet/inch		
	Time Zone	0:London (GMT)		
		+1:Paris,Rome		
		+2:Athens,Cairo		
		+3:Moscow		
		+4:Eerevan,Baku		
		+5:Islamabad		
		+6:Dacca		
		+7:Bangkok		
		+8:Hong Kong		
		+9:Tokyo,Seoul		
		+10:Canberra		
		+11NewCaledonia		
		+12:Wellington		
		-12:Eniwetok		
		-11:Midway is.		
		-10Hawaii(AHST)		
		-9:Alaska(AKST)		
		-8:Oregon (PST)		
		-7:Arizona(MST)		
		-6:Texas (CST)		
		-5:NewYork(EST)		
		-4:Santiago		
		-3:Buenos Aires		

First Level	Second Level	Third Level	Fourth Level	Fifth Level
		-2:		
		-1:Cape Verde		
	Date Format	yyyy/mm/dd *		
		dd/mm/yyyy		
		mm/dd/yyyy		
	Date & Time	Date	yyyy/mm/dd (*8)	
		Time	hh:mm	
	Language	[English]*		
		日本語		
		[Français]		
		[Italiano]		
		[Deutsch]		
		[Español]		
		[Русский]		
		中文 (简体字)		
		한국어		
	Contrast Adj.	-4, -3, -2, -1, 0*, +1, +2, +3, +4		
	Reset PaprSetngs	No		
		Yes		
Test Print	Status Print	No		
		Yes		
	Media Details	No		
		Yes		
	Print Job Log	No		
		Yes		
	Menu Map	No		
		Yes		
	Nozzle Check	No		

First Level	Second Level	Third Level	Fourth Level	Fifth Level
		Yes		
Information	System Info			
	Error Log	##### - ####		
	Job Log	(Choose from information about the latest three print jobs.)	Document Name	
			User Name	
			Page Count	
			Job Status	
			Print Start Time	
			Print End Time	
			Print Time	
			Print Size	
			Media Type	
			Interface	
			Ink Consumed	

*1: Available only if a roll is loaded.

*2: Available only if **Chk Remain.Roll** is **On**.

*3: Available if **Feed Priority** is **Automatic** or **Print Length**.

*4: Not displayed if **IP Mode** is **Manual**.

*5: For information on the types of paper the printer supports, refer to the Paper Reference Guide.

(→P.108) The paper type setting in the printer driver and related software (as well as on the Control Panel) is updated when you install the printer driver from the User Software CD-ROM or if you change paper information by using the Media Configuration Tool. See the Media Configuration Tool Guide (Windows) or Media Configuration Tool Guide (Macintosh).

*6: Not displayed if **NetWare** is **Off**.

*7: Not displayed if **Auto Detect** is **On**.

*8: Follows the setting in **Date Format**.

*9: Available after you have used **Advanced Adj.** in **Auto Head Adj.** once.

*10: Not displayed if **IP Mode** is **Automatic**.

*11: Follows the setting in **Length Unit**.

*12: Select **Yes** to restore **Paper Details** to the factory default values. Any paper type settings you have changed on the Control Panel of the printer are restored to the original values when you install the printer driver from the User Software CD-ROM or if you update paper information by using the Media Configuration Tool.



Caution

- Only the following menus are displayed during printing.
 - Menu Durng Prtng
If you press the **Online** button while printing to pause printing and then press the **Menu** button, **Head Cleaning**, **Fine Band Adj.**, and **Information** are displayed.

Submenus

Each time you press the **Information** button on the Control Panel, printer information is displayed in the following order.

- The remaining Maintenance Cartridge capacity and ink levels

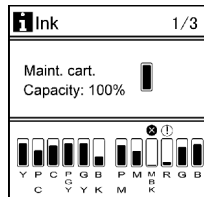

- Information on the loaded paper



- Printer information

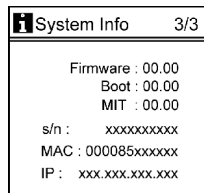

For details on submenu screens, see “Submenu Display”. (→P.61)

Main menu during printing

The structure of the main menu during printing is as follows.

For instructions on menu operations, see "Main Menu Operations". (→P.30)

For details on menu items available during printing, see "Main Menu Settings (During Printing)". (→P.59)

First Level	Second Level	Third Level	Fourth Level	Fifth Level
Menu Durng Prtng	Head Cleaning	Head Cleaning A		
		Head Cleaning B		
	Fine Band Adj.	From -5 to 5		
	Information	System Info		
		Error Log	##### - ####	
		Job Log	(Choose from information about the latest three print jobs.)	Document Name
				User Name
				Page Count
				Job Status
				Print Start Time
				Print End Time
				Print Time
				Print Size
				Media Type
				Interface
				Ink Consumed

Main Menu Settings

Main menu items are described in the following tables.

For instructions on menu operations, see “Main Menu Operations”. (→P.30)

For details on menu levels and values, see “Menu Structure”. (→P.35)

Setting Item	Description, Instructions
Paper Cutting	This command is available only if a roll is loaded. Choose Yes to cut the roll at the current position. If the roll is not already at the cut position, the roll will be automatically advanced to that position and then cut.
Rep. Ink Tank	When replacing the Ink Tank , choose Yes and follow the instructions on the screen. (→P.614)
Head Cleaning	Specify Printhead cleaning options. (→P.624) Choose Head Cleaning A if printing is faint, oddly colored, or contains foreign substances. Choose Head Cleaning B if no ink is printed at all, or if printing is not improved by Head Cleaning A .
Media Menu	Specify the type and size of paper. (→P.50)
Paper Details	Specify detailed paper-related settings, including the ink drying time and borderless printing options. (→P.51)
Adjust Printer	Adjust the Printhead alignment or amount of feed by printing a test pattern. (→P.53)
Interface Setup	Configure the EOP timer and network settings. (→P.54)
Maintenance	Access maintenance settings when replacing the Printhead or preparing to move the printer. (→P.55)
System Setup	Specify the printer system settings, including the date format and display language. (→P.56)
Test Print	Choose Status Print to print information about the printer. Choose Media Details to print the paper settings as specified in Paper Details . Choose Print Job Log to print a record of print jobs, including the paper type and size, amount of ink used, and so on. (Information on ink consumption is general, not specific in nature.) Choose Menu Map to print a list of the main menu options. Choose Nozzle Check to print a test pattern for checking the nozzles.
Information	Displays information about the printer and record of print jobs. (→P.58)

Media Menu

Setting Item	Description, Instructions
Manual PaperType (*1)	Choose the type of sheets to be loaded manually. (→P.162)
Manual PaperSize (*1)	Choose the size of paper to be loaded manually. (→P.163)
Roll Media Type (*1)	Choose the size of the roll. (→P.124)
Chk Remain.Roll	Choose On to print a barcode at the end of a roll before you remove it. The printed barcode can be used in managing the amount of roll paper left. Choose Off if you prefer not to print the barcode.
Roll Length Set	Displayed if Chk Remain.Roll is On . If a barcode is not printed on rolls, specify the roll length. The roll length is displayed in meters or feet, depending on the setting in Length Unit .

*1: For information on the types of paper the printer supports, refer to the Paper Reference Guide. (→P.108) The paper type setting in the printer driver and related software (as well as on the Control Panel) is updated when you install the printer driver from the User Software CD-ROM or if you change paper information by using the Media Configuration Tool. See the Media Configuration Tool Guide (Windows) or Media Configuration Tool Guide (Macintosh).

Paper Details

Setting Item	Description, Instructions	
(The paper type is displayed here.)(*1)	Roll DryingTime	Specify the time to wait for the ink to dry for each sheet.
	Scan Wait Time	Specify the time to wait for the ink to dry between each scan in bidirectional printing, in consideration of how quickly the ink dries. Note that printing will take longer if you specify a wait time.
	Feed Priority	Specify exact paper feeding, if desired. Normally, select Automatic . Choose Print Length if you prefer to feed the paper an exact amount. However, note that choosing Print Length may result in slight banding in the direction of Carriage scanning.
	Adjust Length	Displayed if Feed Priority is Print Length . Adjustment relative to the amount of stretching or shrinkage of the current paper. Enter either the adjustment results from Print Pattern or the discrepancy that you measured (as a percentage). For paper that tends to stretch, increase the feed amount by choosing a higher adjustment value. For paper that tends to shrink, decrease the feed amount by choosing a lower adjustment value.
	Head Height	Adjust the Printhead height. (→P.588)
	Skew Check Lv.	If you print on Japanese paper (washi) or other handmade paper that has an irregular width, choose Loose for a higher skew detection threshold, or choose Off to disable skew detection. However, if paper is loaded askew when detection is Off , note that paper jams or Platen soiling may occur.
	VacuumStrngth	Specify the level of suction that holds paper against the Platen . (→P.595)
	NearEnd RollMrgn	Specify the minimum margin at the leading edge of roll paper to ensure better printing quality at the leading edge. Note that if you choose 3mm , it may lower the printing quality at the leading edge and affect feeding accuracy. The printed surface may be scratched, and ink may adhere to the leading edge. It may also cause the Platen to become soiled.
	Cut Speed	Choose the cutting speed. If you use adhesive paper, choosing Slow helps prevent adhesive from sticking to the cutter and keeps the cutter sharp.
Trim Edge First	If a roll is loaded, the end of the paper will be cut. Choose On to have 40 mm (1.6 in) cut off the leading edge of the roll after you load the roll. Scraps are then removed. When Automatic is selected, if the left and right side of the leading edge of the roll are uneven (by 3 mm [0.12 in] or more), the edge is cut an amount relative to the slant to ensure a straight edge after you load the roll. Scraps are then removed. If the unevenness is less than 3 mm or if Off is selected, the edge is not cut and scraps are not removed.	

Setting Item	Description, Instructions
(The paper type is displayed here.)(*1)	Cutting Mode Specify whether or not to cut with the standard round-bladed cutter. Choose Automatic to have the roll cut automatically after printing. If you choose Eject , the paper is cut after you hold down the Stop button for a second or more. If you choose Manual , the paper will not be cut after printing. Instead, a line will be printed at the cut position.
	Bordless Margin Adjust the margin during borderless printing. Choose Automatic to have the printer automatically detect the paper width and configure the margin settings for borderless printing. If margins are mistakenly created when Automatic is selected, choose Fixed . In this case, the paper width is not detected automatically, and the document is printed without borders, using the margin settings required by the printer.
	CutDustReduct. Choose On to reduce the amount of debris generated when cutting film and similar media by printing a line at the cut position. This option reduces the amount of debris given off after cutting. It also helps prevent adhesive from sticking to the cutter and keeps the cutter sharp if you use adhesive paper. (→P.134)
	NearEnd Sht Mrgn Specify a margin at the leading edge of sheets to ensure better printing quality at the leading edge. Note that if you choose 3mm , it may lower the printing quality at the leading edge and affect feeding accuracy. The printed surface may be scratched, and ink may adhere to the leading edge.
	Manual Feed When printing manually, choose the Paper Feed Slot . Normally, choose Top . For heavyweight paper such as POP Board , choose Front .
	Return Defaults Choose Yes to restore Paper Details to the factory default values.

*1: For information on the types of paper the printer supports, refer to the Paper Reference Guide. (→P.108) The paper type setting in the printer driver and related software (as well as on the Control Panel) is updated when you install the printer driver from the User Software CD-ROM or if you change paper information by using the Media Configuration Tool.

Adjust Printer

Setting Item		Description, Instructions
Auto Head Adj.	Standard Adj.	Choose Yes to have the printer print and read a test pattern for the automatic adjustment of Printhead alignment relative to the printing direction. (→P.584)
	Advanced Adj.	Choose Yes to have the printer print and read a test pattern for the automatic adjustment of Printhead alignment relative to the nozzle and printing direction. (→P.584)
	Auto Print	Choose On to have the printer automatically execute the Advanced Adj. operations after you replace the Printhead . (→P.584)
Manual Head Adj		Choose Yes to print a test pattern for adjustment of Printhead alignment relative to the printing direction. Enter the adjustment value manually based on the resulting pattern. (→P.586)
Auto Band Adj.	Standard Adj.	Choose Yes to have the printer print and read a band adjustment test pattern for automatic adjustment of the feed amount. (→P.589)
	Advanced Adj.	Choose this option when using paper other than genuine Canon paper, or paper for purposes other than checking output. Choose Yes to have the printer print and read a band adjustment test pattern for automatic adjustment of the feed amount. Note that this function takes more time and requires more ink than Standard Adj. (→P.589)
Manual Band Adj		Choose Yes to print a test pattern for adjusting the feed amount based on the paper type.
Adj Far Ed Feed		Choose Yes for adjustment of the feed amount of the trailing edge.
Adjust Length		Choose Yes to print a test pattern for adjustment relative to paper stretching or shrinkage, after which you can enter the amount of adjustment. (→P.596)
Calibration	Auto Adjust	Choose Yes for automatic adjustment of the adjustment value after a test pattern for color calibration is printed. The latest color calibration adjustment value is applied for all paper.
	Calibration Log	The date of color calibration and the paper type is indicated on the Display Screen .
	Use Adj. Value	Select Disabled and press the OK button to print without applying the color calibration adjustment value. The printer driver settings are given priority. Select Enabled and press the OK button to apply the color calibration adjustment value in printing. However, the printer driver settings will be given priority.
	Return Defaults	Clears the color calibration adjustment value and log.

Interface Setup

Setting Item		Description, Instructions	
EOP Timer		Specify the timeout period before cancellation of print jobs that cannot be received by the printer.	
TCP/IP	IP Mode	Choose whether the printer IP address is configured automatically or a static IP address is entered manually.	
	Protocol	DHCP	Specify the protocol used to configure the IP address automatically.
		BOOTP	
		RARP	
	IP Setting	IP Address	Specify the printer network information when using a static IP address. Enter the IP address assigned to the printer, as well as the network subnet mask and default gateway.
		Subnet Mask	
Default G/W			
NetWare	NetWare	Specify the NetWare protocol. To apply your changes, choose Register Setting .	
	Frame Type	Specify the frame type to use.	
	Print Service	Choose the print service.	
AppleTalk		Specify whether to use the AppleTalk protocol. To apply your changes, choose Register Setting .	
Ethernet Driver	Auto Detect	Specify the communication method. To apply your changes, choose Register Setting . Choose On for automatic configuration of the LAN communication protocol. Choose Off to use settings values of Comm.Mode and Ethernet Type .	
	Comm.Mode	Choose the LAN communication method.	
	Ethernet Type	Choose the LAN transfer rate.	
	Spanning Tree	Choose whether spanning-tree packets are supported over the LAN.	
	MAC Address	Displays the MAC address.	
Ext. Interface		Choose the expansion interface.	
Return Defaults		Execute? is displayed if you press the ▼ button. Choose OK to restore the network settings to the default values.	

Maintenance

Setting Item	Description, Instructions
Repl. maint cart	When replacing the Maintenance Cartridge , choose Yes and follow the instructions on the screen. (→P.632)
Replace P.head	Not displayed during a warning message that the remaining Maintenance Cartridge capacity is low. When replacing the Printhead , choose Yes and follow the instructions on the screen. (→P.625)
Move Printer	When transferring the printer to another location, follow the instructions on the screen. (→P.648)
Clean Platen	After you select Yes , the Carriage is moved and the printer is ready for Platen cleaning.
Spur Cleaning	Click Yes to clean the spurs. (→P.644)

System Setup

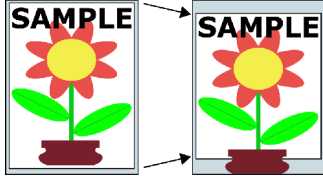
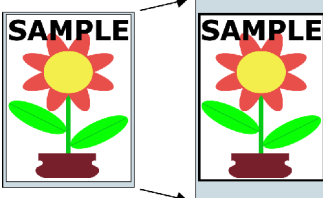
Setting Item		Description, Instructions
Warning	Buzzer	Set the buzzer. Choose On for the buzzer to sound once for warnings and three times for errors.
	Detect Mismatch	Choose Warning for notification (display of a warning message) during printing if the paper type specified in the printer menu does not match the paper type in the printer driver. Choose None to continue to print without notification. Choose Pause to have printing paused under these circumstances. In this case, you can continue printing by pressing the Online button.
Keep Media Size		<p>Select On to use the paper size setting as the basis for printing instead of other settings. The margin setting of the printer menu will be used instead of the margin setting of the printer driver if the latter is smaller, which may prevent text or images in the trailing margin from being printed.</p>  <p>Choose Off to use the printer driver settings instead. Even if the margin setting of the printer driver is smaller than that of the printer driver, text or images will not be cut off. However, this requires longer paper because the actual margin will be equal to the margin setting of the printer driver plus the margin setting of the printer menu.</p> 
Paper Size Basis	Sheet Selection	If sheet size detection is activated, choose whether ISO A3+ or 13"x19"(Super B) is applied when an intermediate size is detected.
	Roll Selection 1	If roll size detection is activated, choose whether ISO A3 (297mm) or 300mm Roll is applied when a roll of an intermediate width is detected.
	Roll Selection 2	If roll size detection is activated, choose whether 10in. (254mm) or JIS B4 (257mm) is applied when a roll of an intermediate width is detected.
TrimEdge Reload		<p>When Automatic is selected, the leading edge will be cut as needed, taking into account how long the paper has been loaded without being printed. (However, it is not cut if Cutting Mode is set to Manual.)</p> <p>Choose On to cut the leading edge.</p>

Setting Item		Description, Instructions
Noz. Check Freq.		Specify the timing for automatic checks of nozzle clogging. Choose 1 page to check once per printed page. Choose 10 pages to check once per ten printed pages. Choose Automatic to have the printer automatically adjust the timing for checks based on the frequency of nozzle use.
Sleep Timer		Specify the period before the printer enters Sleep mode.
Length Unit		Choose the unit of measurement when roll length is displayed. You can switch the unit displayed for Roll Length Set and the remaining paper amount displayed in the submenu.
Time Zone		Specify the time zone. Time zone options indicate a main city in this time zone and the difference from Greenwich Mean Time.
Date Format		Specify the date format.
Date & Time	Date	Set the current date.
	Time	Set the current time.
Language		Specify the language used on the Display Screen .
Contrast Adj.		Adjust the Display Screen contrast level.
Reset PaprSetngs		Restores settings that you have changed with Media Configuration Tool to the factory default values. If paper added using the Media Configuration Tool was used for color calibration, such color calibration can no longer be applied to any type of paper.

Information

Setting Item		Description, Instructions	
System Info	Version	Firm	Displays the printer firmware version.
		Boot	Displays the version of the boot ROM.
		MIT	Displays the version of the MIT database format.
	s/n		Displays the printer's serial number.
	MAC		Displays the MAC address of the printer.
	IP		Displays the printer's IP address.
Error Log	##### -####		Displays the most recent error messages (up to two).
Job Log	(Choose from information about the latest three print jobs.)	Document Name	Displays the document name in the last print job.
		User Name	Displays the name of the user who sent the print job.
		Page Count	Displays the number of pages in the print job.
		Job Status	Displays the results of the print job processed.
		Print Start Time	Displays the time when the print job was started.
		Print End Time	Displays the time when the print job was finished.
		Print Time	Displays the time required to print the job.
		Print Size	Displays the paper size in the print job.
		Media Type	Displays the paper type in the print job.
		Interface	Displays the interface used for the print job.
		Ink Consumed	Displays the ink consumption.

☰ Main Menu Settings (During Printing)

Main menu items during printing are described in the following tables.

For instructions on menu operations, see “Main Menu Operations”. (→P.30)

For details on menu levels and values, see “Menu Structure”. (→P.35)

Setting Item	Description, Instructions
Head Cleaning	Specify Printhead cleaning options. (→P.624) Choose Head Cleaning A if printing is faint, oddly colored, or contains foreign substances. Choose Head Cleaning B if no ink is printed at all, or if printing is not improved by Head Cleaning A .
Fine Band Adj.	Displayed during print jobs. For fine-tuning the feed amount.
Information	Displays information about the printer and record of print jobs. (→P.60)

Information

Setting Item		Description, Instructions	
System Info	Version	Firm	Displays the printer firmware version.
		Boot	Displays the version of the boot ROM.
		MIT	Displays the version of the MIT database format.
	Ext I/F		Displays the name of interfaces compatible with the expansion slot.
	s/n		Displays the printer's serial number.
	MAC		Displays the MAC address.
	IP		Displays the printer's IP address.
Error Log	##### - ####		Displays the most recent error messages (up to two).
Job Log	(Choose from information about the latest three print jobs.)	Document Name	Displays the document name in the last print job.
		User Name	Displays the name of the user who sent the print job.
		Page Count	Displays the number of pages in the print job.
		Job Status	Displays the results of the print job processed.
		Print Start Time	Displays the time when the print job was started.
		Print End Time	Displays the time when the print job was finished.
		Print Time	Displays the time required to print the job.
		Print Size	Displays the paper size in the print job.
		Media Type	Displays the paper type in the print job.
		Interface	Displays the interface used for the print job.
		Ink Consumed	Displays the ink consumption.

Submenu Display

Press the **Information** button to display this information, one after another: the Maintenance Cartridge capacity and remaining ink levels, paper information, and printer information.

Each time you press the **Information** button, the following submenus are displayed.



Note

- Press any button other than the **Information** button to restore the previous mode.
- After you display a submenu, the printer will revert to the previous mode in about ten seconds if no print job is received or if you do not operate the printer.

Remaining Maintenance Cartridge capacity and ink levels

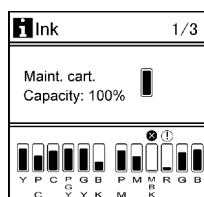

The remaining Maintenance Cartridge capacity is shown on the top level of the Display Screen.

The remaining level of each ink is shown on the bottom level of the Display Screen. Ink levels shown on the Display Screen correspond to the inks identified by the color labels on the bottom of the Display Screen.

These symbols may be displayed above the ink level: “!” if ink is low, “x” if no ink is left, and “?” if you have deactivated ink level detection.

Remaining ink is indicated as follows.

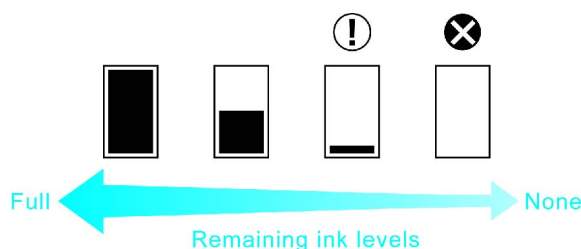

Information of the loaded paper

Here, the paper size, type, and related printer settings are displayed.

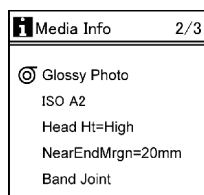

Printer information

Displays the firmware version, serial number, MAC address, IP address, and interface information.

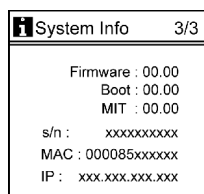

☐ Status Print

You can print a **Status Print** report indicating the current status of the printer.

With **Status Print**, information is printed regarding the printer firmware version, various settings, and the utilization level of consumables.

Printing Status Print Reports

1. Load paper.
If using sheets, load paper A4/Letter-sized. You will need at least four sheets.
2. Press the **Menu** button to display **MAIN MENU**.

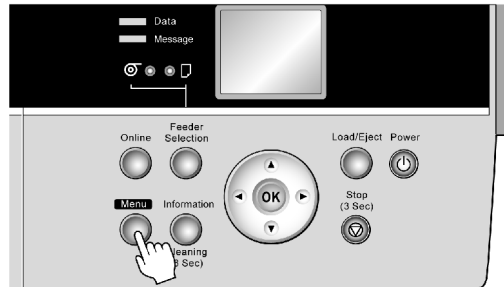

3. Press ▲ or ▼ to select **Test Print**, and then press the ► button.
4. Press ▲ or ▼ to select **Status Print**, and then press the ► button.
5. Press ▲ or ▼ to select **Yes**, and then press the **OK** button.

Checking the information in the Status Print report

The following information is included in the **Status Print** report.

Canon imagePROGRAF iPF6100 Status Print		Printer model
Firm	Firmware version	
Boot	Boot version	
MIT	MIT format version	
S/N	Printer serial number	
MC	Maintenance Cartridge capacity (%)	
Y, PC, C, PGY, GY, BK, PM, M, MBK, R, G, and B	Ink levels. The remaining ink is displayed in a five-level scale.	

Media Menu		Information on the loaded paper.
	Roll Media Type	
	Check Remain. Roll	
	Cut Sheet Type	
Adjust Printer		Current printer settings.
	Head Adjust	Printhead adjustment value.
	Auto Print	
	A1-F2	
Feed Priority		Settings related to paper feeding.
Adjust Length		
Calibration		The color calibration setting value.
	Execution Log	The calibration log.
	Date:	Indicates the date calibration was performed and the type of paper used.
	Media:	
	Use Effect Value:	This value indicates whether the results of color calibration are used or not.

Control Panel

Interface Setup		Current network settings.	
	EOP Timer		Sets the elapsed time between receiving last data and canceling printing.
	TCP/IP		Settings related to TCP/IP .
		IP Mode	
		Protocol	
		DHCP	
		BOOTP	
		RARP	
		IP Setting	IP Setting values.
		IP Address	
		Subnet Mask	
		Default G/W	
	NetWare		NetWare settings.
		Frame Type	
		Print Service	
	AppleTalk		Values that specify whether AppleTalk is active or not.
	Ethernet Driver		Ethernet Driver settings.
		Auto Detect	
		Comm.Mode	
		Ethernet Type	
		Spanning Tree	
		MAC Address	

System Setup		
	Warning	Current warning and error settings.
	Buzzer	
	Detect mismatch	
	Keep Media Size	Current paper-related settings.
	Sheet Selection 1	
	Sheet Selection 2	
	Roll Selection 1	
	Roll Selection 2	
	Nozzle Check	
	Sleep Timer	General printer settings.
	Length Unit	
	Time Zone	
	Date Format	
	Language	
	Contrast Adj.	
Information		
	RAM	
	Ext. Interface	
	Error Log	

Control Panel

Network (RemoteUI)		Current network settings used by RemoteUI.
TCP/IP		
	Frame Type	
	Use BOOTP	
	Use DHCP	
	Use RARP	
	Raw Mode Bi-direction	
	Enable DNS Dynamic Update	
	Use Zeroconf Function	
	IP Address*	
	Subnet Mask*	
	Gateway Address*	
	LPD Printing	
	IPP Printing	
	IPP Printer URI	
	RAW Printing	
	Raw Port Number	
	FTP Printing	
	SMTP Server Address*	
	Primary DNS Server Address*	
	Secondary DNS Server Address*	
	DNS Host Name*	
	DNS Domain Name*	
	Multicast DNS Service Name	

*: Blank if the status has been saved by using Status Monitor.

NetWare		Current NetWare settings.
	Frame Type	
	IPX External Network Number*	
	Node Number*	
	Print Service	

*: Depending on the NetWare print service settings, information on one of the following four items is printed.

	Bindery PServer	Values set when NetWare > Print Service > Bindery PServer is selected.
	File Server Name*	
	Print Server Name*	
	Print Server Password*	
	Polling Interval	
	RPrinter	Values set when NetWare > Print Service > RPrinter is selected.
	Print Server Name*	
	Printer Number*	
	NDS PServer	Values set when NetWare > Print Service > NDS PServer is selected.
	Tree Name*	
	Context name*	
	Print Server Name*	
	Print Server Password*	
	Polling Interval	
	NPrinter	Values set when NetWare > Print Service > NPrinter is selected.
	Print Server Name*	
	Printer Number*	

*: Blank if the status has been saved by using Status Monitor.

Control Panel

AppleTalk		Current AppleTalk settings.
	Phase Type	
	Name*	
	Network Number*	
	Zone*	

*: Blank if the status has been saved by using Status Monitor.

HEAD LOT NUMBER		Printhead lot number.
	LOT R,L	

PARTS STATUS		Utilization status of replacement parts that require servicing.
	COUNTER A-I	

COUNTER		Utilization status of the cutter, media, and other items (indicating how much they have been used).	
	CUTTER		
	MEDIA		
	MEDIA1-7		
			NAME
			TTL
			ROLL
			CUTSHEET
	AFTER INSTALLATION		

Optional accessories

Stand

The printer can be mounted on the following Stand.

- Printer Stand ST-25

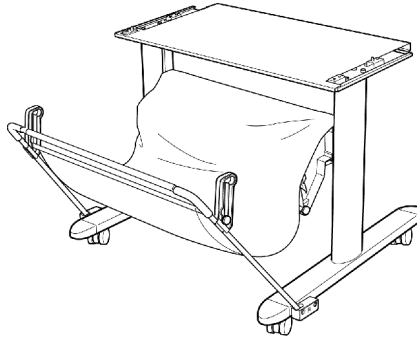

Note

- For details on assembling the Stand, refer to the instructions provided with the Stand.

Roll Holder Set

A set of parts including a Roll Holder, Holder Stopper (for 2- and 3-inch paper cores), 3-Inch Paper Core Attachment, and Spacer for Borderless Printing (used for both 2- and 3-inch paper cores).

To load a roll with a 3-inch paper core, insert the 3-Inch Paper Core Attachment on the Roll Holder and attach the Holder Stopper for 3-inch paper cores. If you use an A1 (594 mm [23.4 in]) roll or A2 (420 mm [16.5 in]) roll for borderless printing, insert the Spacer for Borderless Printing on the Roll Holder.

- Roll Holder Set RH2-24
 - Roll Holder

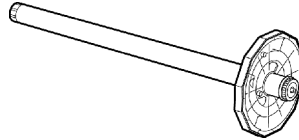

- Holder Stopper (for 2- and 3-inch paper cores (a) and (b))

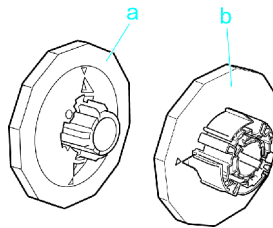

- 3-Inch Paper Core Attachment

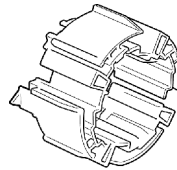

- Spacer for Borderless Printing



For instructions on installing these parts, see “Attaching Accessories to the Roll Holder”. (→P.144)

IEEE 1394 Expansion Board

An interface board to add an IEEE 1394 (also called "FireWire") port.

- IEEE1394 Expansion Board EB-05

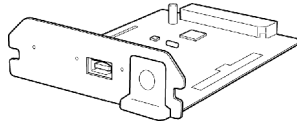

For instructions on installing the IEEE 1394 expansion board, refer to the documentation provided with the optional IEEE 1394 expansion board.

Printer Specifications

Specifications



Important

- This information is subject to change as the printer is updated.
- The following values may vary depending on the operating environment.

Printer

Power supply		100-120 V AC (50/60 Hz), 220-240 V AC (50/60 Hz)
Power consumption	In operation	100 W max.
	Sleep mode	100-120 V: 5 W max. (8 W max. when an IEEE 1394 (FireWire) expansion board is installed.) 220-240 V: 6 W max. (9 W max. when an IEEE 1394 (FireWire) expansion board is installed.)
	Off	1 W max. (*1)
Operating noise		Approx. 49 dB (A) max.
Operating environment	Temperature	15-30°C (59-86°F)
	Humidity	10-80%, non-condensing
Dimensions (W × D × H)	Printer only	1,177×670×348 mm (46.3 × 26.4 × 13.7 in)
	With stand	1,177×861×993 mm (46.3 × 33.9× 39.1 in)
Weight (not including the Printhead and Ink Tank)	Printer only	51 kg (112.4 lb)
	With stand	-
Space required for installation (*2)	Printer only	1,477×1,770×648 mm (58.1 × 80.7 × 25.5 in)
	With stand	1,477×1,770×1,294 mm (58.1 × 80.7 × 50.9 in)
Applicable standards		International Energy Star Program, Law on Promoting Green Purchasing, GPN, RoHS, The Eco Declaration, WEEE, U.S. presidential directives

*1: The printer uses a trace amount of power even when turned off. To stop all power consumption, turn off the printer and unplug the power cord.

*2: Normally, you will need to ensure an unobstructed space of 800 mm (31.5 in) in front of the printer, 300 mm (11.8 in) behind, 150 mm (5.9 in) on both sides, and 300 mm (11.8 in) above the printer. Only when printing from the Front Paper Feed Slot, leave 1,300 mm (51.2 in) of unobstructed space in front of the printer and 700 mm (27.6 in) behind it.

Printing performance

Print method	Bubblejet
Maximum resolution	2400 dpi horizontally (*1) × 1200 dpi vertically
Printhead	PF-03
Number of nozzles	2,560 per color

*1: Prints with a minimum 1/2400 inch dot pitch between ink droplets.

Interface

Expansion Board Slots		1
USB 2.0(*1)	Format	Internal port
	Mode	Full-speed (12 Mbps), high-speed (480 Mbps), bulk transfer
	Connector	Series B (4-pin)
Ethernet (*3)	Format	Internal port
	Specification	IEEE 802.3 10BASE-T, IEEE 802.3u 100BASE-TX /Auto-Negotiation, and IEEE 802.3x Full Duplex
	Protocols	IPX/SPX (Netware 4.2, 5.1, 6.0), SNMP, HTTP, TCP/IP, AppleTalk
IEEE 1394 (*2)	Format	Optional boards (slot type)
	Specification	IEEE 1394-1995, conforms to P1394a Specification ver. 2.0, half duplex, Data/Strb differential serial
	Transfer speed	100/200/400 Mbps
	Connector	Conforms to IEEE 1394-1995 (6-pin), no power supply

*1: Use in USB 2.0 High Speed mode requires the following environment:

- Computer: USB 2.0 High-Speed-compatible
- Operating system: Windows
Vista/Windows Server 2003/Windows XP/Windows 2000 or Mac OS X ver. 10.3.3 or later
- USB 2.0 driver: Microsoft
USB 2.0 driver (available from Windows Update or the Service Pack.)
- USB cable: Certified
USB 2.0 cable

*2: One IEEE 1394 (FireWire) expansion board can be installed.

*3: In the European Union, use a shielded LAN cable to comply with EN 55022: 1998 +A1: 2000 and A2: 2003.

Ink

Ink Tank	Y Ink Tank (Yellow Ink)	Pigment ink	PFI-101Y (user-replaceable)
	PC Ink Tank (Photo Cyan Ink)	Pigment ink	PFI-101PC (user-replaceable)
	C Ink Tank (Cyan Ink)	Pigment ink	PFI-101C (user-replaceable)
	PGY Ink Tank (Photo Gray Ink)	Pigment ink	PFI-103PGY (user-replaceable)
	GY Ink Tank (Gray Ink)	Pigment ink	PFI-103GY (user-replaceable)
	BK Ink Tank (Black Ink)	Pigment ink	PFI-103BK (user-replaceable)
	PM Ink Tank (Photo Magenta Ink)	Pigment ink	PFI-101PM (user-replaceable)
	M Ink Tank (Magenta Ink)	Pigment ink	PFI-101M (user-replaceable)
	MBK Ink Tank (Matte Black Ink , or black ink for matte paper)	Pigment ink	PFI-103MBK (user-replaceable)
	R Ink Tank (Red Ink)	Pigment ink	PFI-101R (user-replaceable)
	G Ink Tank (Green Ink)	Pigment ink	PFI-101G (user-replaceable)
	B Ink Tank (Blue Ink)	Pigment ink	PFI-101B (user-replaceable)
Capacity			130 ml per color (*1)

*1: Printable pages when using the provided Starter Ink Tanks (90 ml per tank)

Paper (*1)

Paper width		250-610 mm (9.8-24 in)	
Maximum length per page	Sheets	Tray (top)	1,600 mm (63.0 in)
		Tray (front)	914 mm (36.0 in)
	Rolls	18 m (19.7 yd.)	
Thickness	Sheets	Tray (top)	0.08-0.8 mm (0.003-0.031 in)
		Tray (front)	0.8-1.5 mm (0.031-0.060 in)
	Rolls	0.08-0.8 mm (0.003-0.031 in)	
Paper size	Sheets	Supported sizes	ISO A1, ISO A2, ISO A2+, ISO A3, ISO A3+, ISO A4, ISO B2, ISO B3, ISO B4, JIS B2, JIS B3, JIS B4, 22"x34" (ANSI D), 17"x22" (ANSI C), 11"x17" (Ledger), 13"x19" (SuperB), Letter (8.5"x11"), Legal (8.5"x14"), 24"x36" (ARCH D), 18"x24" (ARCH C), 12"x18" (ARCH B), 9"x12" (ARCH A), DIN C2, DIN C3, DIN C4, 20"x24", 18"x22", 14"x17", 12"x16", 10"x12", 10"x15", 8"x10", US Photo 16"x20", Poster 20"x30", 13"x22", Poster 300x900 mm
		Tray (top)	<ul style="list-style-type: none"> • Width: 203-610 mm (8-24 in) • Length: 279-1,600 mm (11-63 in)
		Tray (front)	<ul style="list-style-type: none"> • Width: 250-610 mm (8-24 in) • Length: 350-914 mm (14-36 in)
	Rolls	8 inches (203 mm), 10 inches (254 mm), JIS B4 (257 mm), ISO A3/A4 (297 mm), Banner (300 mm), A3+ (329 mm), 14 inches (356 mm), 16 inches (407 mm), ISO A2/A3 (420 mm), 17 inches (432 mm), JIS B2/B3 (515 mm), ISO A1/A2 (594 mm), 24 inches (610 mm)	
	Print area	Normal size	Printable area <ul style="list-style-type: none"> • Sheets (Top Paper Feed Slot) Top: 3 mm (0.12 in); bottom: 3 or 23 mm (0.9 in); left and right sides: 3 mm. (The bottom value varies depending on the type of paper.) • Sheets (Front Paper Feed Slot) 3 mm (0.12 in) on top, 23 mm (0.9 in) on bottom, and 3 mm (0.12 in) on both sides • Rolls 3 mm (0.12 in) from each side For information on the recommended print area, see "Print Area". (→P.78)
	Borderless printing (*2)	Printable area (rolls) Entire surface	
	Oversized (*2), (*3)	Printable area Entire surface	
Supported width for borderless printing		10 inches (254 mm), JIS B4 (257 mm), A3+ (329 mm), 14 inches (356 mm), 16 inches (407 mm), ISO A2/A3 (420 mm) (*4), 17 inches (432 mm), JIS B2/B3 (515 mm), ISO A1/A2 (594 mm) (*4), 24 inches (610 mm)	

Printer Specifications

- *1: For information on the types of paper the printer supports, refer to the Paper Reference Guide.
(→P.108)
- *2: Printing may not be possible in some cases, depending on the type and size of paper.
- *3: Load paper at least 6 mm (0.24 in) wider and 6 mm higher than the size selected in **Page Size** for roll paper. Or, load paper at least 6 mm wider and 26 mm (1.0 in) higher for the tray.
- *4: Borderless printing requires the Spacer for Borderless Printing.

Basic Environmental Performance

Printer

Power consumption	Sleep mode	100-120 V: 5 W max. (8 W max. when an IEEE 1394 (FireWire) expansion board is installed.) 220-240 V: 6 W max. (9 W max. when an IEEE 1394 (FireWire) expansion board is installed.)
	Off	1 W max.
Resource efficiency	Weight	Printer only: 51 kg (112.4 lb)
	Dimensions (W × D × H)	Printer only: 1,177×670×348 mm (46.3 × 26.4 × 13.7 in)
	Recycling	Recyclable plastic used for printer body
Product safety	Toxic substances	Structural components: No prohibited brominated flame retardants used (PBB or PBDE)
		Body plastic: No heavy metals (Pb, Hg, Cr[VI], or Cd) or halogenated flame retardants used
	Operating noise	Approx. 49 dB (A) max.

Packaging materials

Heavy metal content (Pb, Hg, Cr[VI], and Cd)	None (none in packaging)
--	--------------------------

Print Area

A margin required by the printer is added with respect to the size of paper loaded in the printer. Except in borderless printing, the actual printing area corresponds to the paper size minus the space for this margin.

		Printable Area			Recommended Print Area		
		Top Edge	Bottom Edge	Sides	Top Edge	Bottom Edge	Sides
Sheets	Top Paper Feed Slot	3 mm (0.12 in)	3/23 mm (0.12/0.91 in)	3 mm (0.12 in)	20 mm (0.79 in)	27 mm (1.06 in)	5 mm (0.20 in)
	Front Paper Feed Slot	3 mm (0.12 in)	23 mm (0.91 in)	3 mm (0.12 in)			
Rolls		0/3 mm (0/0.12 in)	0/3 mm (0/0.12 in)	0/3 mm (0/0.12 in)	20 mm (0.79 in)	5 mm (0.20 in)	5 mm (0.20 in)

Sheets

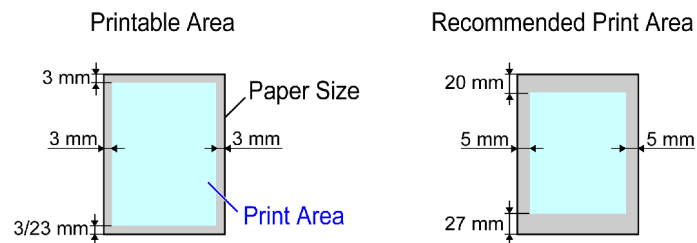

- Printable Area:

Printing from the Top Paper Feed Slot requires a margin of 3 mm (0.12 in) on all sides. (A bottom margin of 23 mm [0.9 in] may sometimes be required.) The bottom margin is 23 mm for some types of paper. For more information, see the Paper Reference Guide. (→P.108)

When printing from the Front Paper Feed Slot, a margin of 23 mm (0.9 in) on all sides is required.

- Recommended print area:

A margin of 20 mm (0.79 in) on top, 27 mm (1.06 in) on bottom, and 5 mm (0.20 in) on left and right sides is required.



Note

- Printable area: The area that can be printed.
- Guaranteed Print Area: We recommend printing within this area.
- To print so that your original matches the print area exactly, use an oversized paper size that includes the required margin. (→P.277)
- You can choose a bottom margin of 3 mm or 23 mm when printing from the Top Paper Feed Slot. In the printer driver, choosing **Manual** in **Media Source** sets the bottom margin at 23 mm. On the other hand, choosing **Manual (3mm margins)** in **Media Source** sets the bottom margin at 3 mm, which provides a larger area for printing. However, the option **Manual (3mm margins)** is not available with the following paper.
 - Fine Art Photo Paper
 - Fine Art Heavyweight Photo Paper
 - Fine Art Textured Paper
- The types of paper listed above may be updated, in some cases. For details on paper types, see the Paper Reference Guide. (→P.108)
- If you set the bottom margin at 3 mm, images in the bottom margin may be distorted. In this case, choose **Manual** in **Media Source** to set the bottom margin at 23 mm.

Rolls

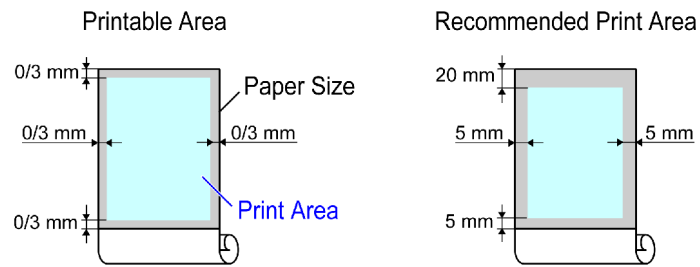

- **Printable Area:**
A margin of 3 mm (0.12 in) on all sides is required. During borderless printing, the margin on all sides is 0 mm. For information on paper compatible with borderless printing, see the Paper Reference Guide. (→P.108)
- **Recommended print area:**
A margin of 20 mm (0.79 in) on top, 5 mm (0.20 in) on bottom, and 5 mm (0.20 in) on left and right sides is required.



Note

- **Printable area:** The area that can be printed.
- **Guaranteed Print Area:** We recommend printing within this area.
- To print so that your original matches the print area exactly, use an oversized paper size that includes the required margin. (→P.277)

Basic Printing Workflow

Printing procedure

Loading and Printing on Rolls

These are the basic steps for loading and printing on rolls.

Follow the steps below to switch to a new roll or a roll of a different type or width before printing.



Note

- If a sheet is loaded in the Top Paper Feed Slot, remove it before this procedure. (→P.146)
- Before printing banners or other long documents, spread a clean cloth or paper on the floor or use the Output Stacker to prevent the printed surface from becoming dirty from the floor after printing.
- If you will wait for the ink to dry after printing and simply eject the document, you can deactivate automatic cutting and print a cut line instead. (→P.129)

1. Turn the printer on. (→P.19)

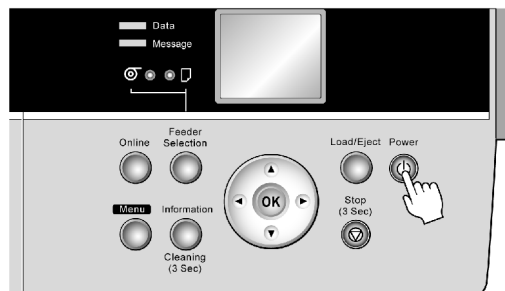

2. Select roll paper as the paper source. (→P.115)

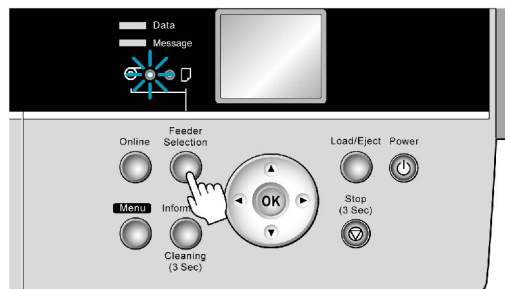

3. Load a roll on the Roll Holder. (→P.116)



Note

- When switching rolls, first remove the current roll from the Roll Holder. (→P.118)

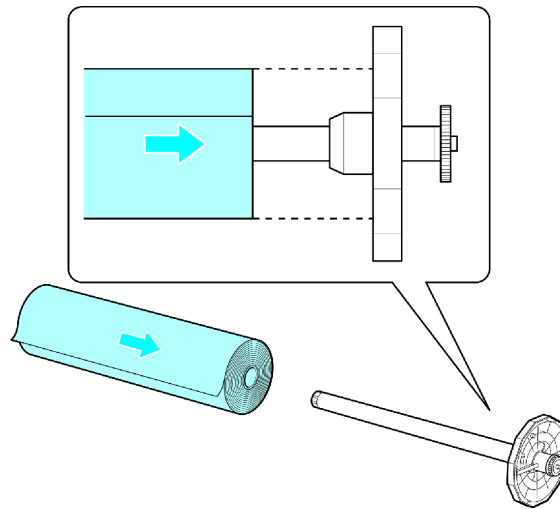

4. Load the roll in the Roll Feed Unit. (→P.119)

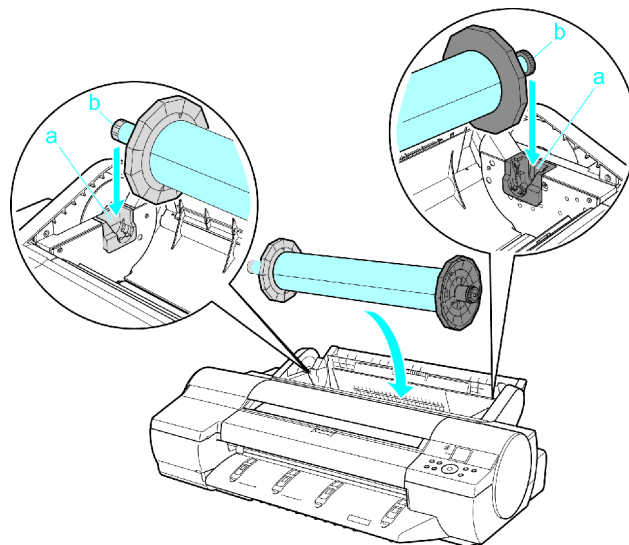

5. Select the paper type. (→P.124)

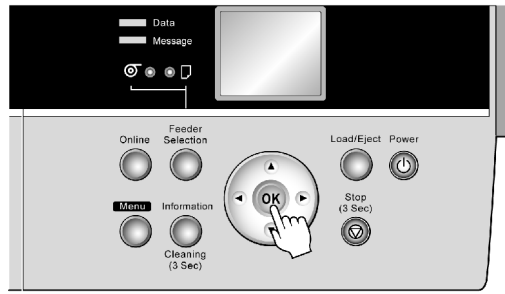

6. Select the paper length. (→P.125)

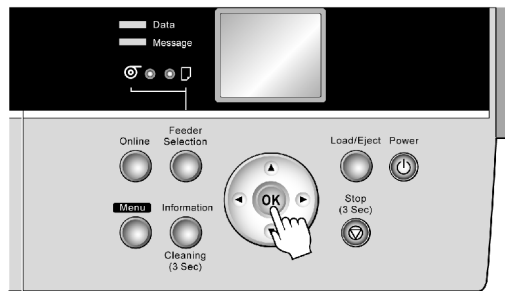

7. Complete settings in the printer driver for the type of paper and other details.

- Specifying Paper in the Printer Driver (Windows) (→P.93)
- Specifying Paper in the Printer Driver (Mac OS X) (→P.95)
- Specifying Paper in the Printer Driver (Mac OS 9) (→P.97)

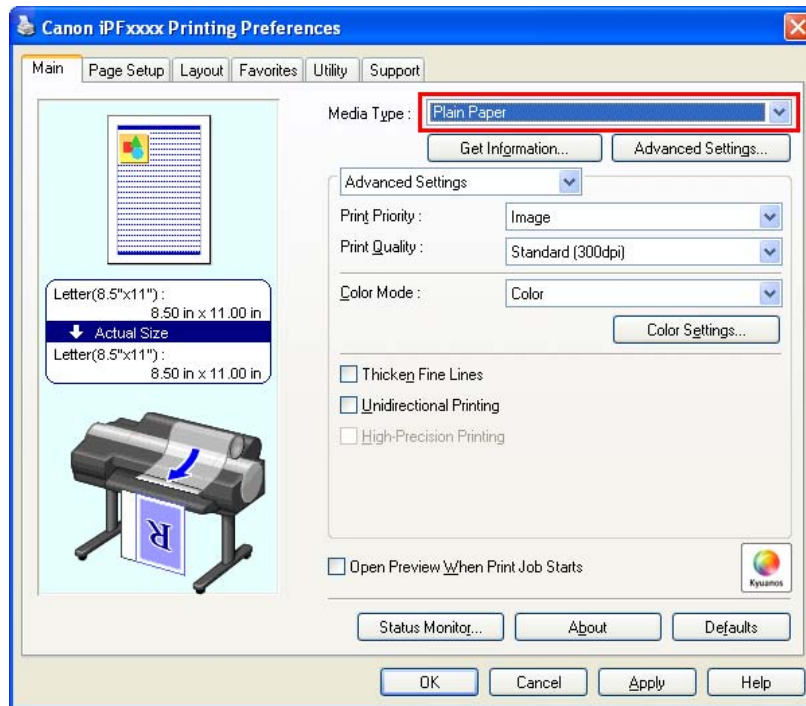

Important

- Always specify the same type and size of paper in the printer menu and printer driver. If the type and size do not match, an error message will be displayed and printing is not possible.
 - Paper Size Mismatch (→P.692)
 - Paper Type Mismatch (→P.691)
 - Paper Mismatch (→P.691)

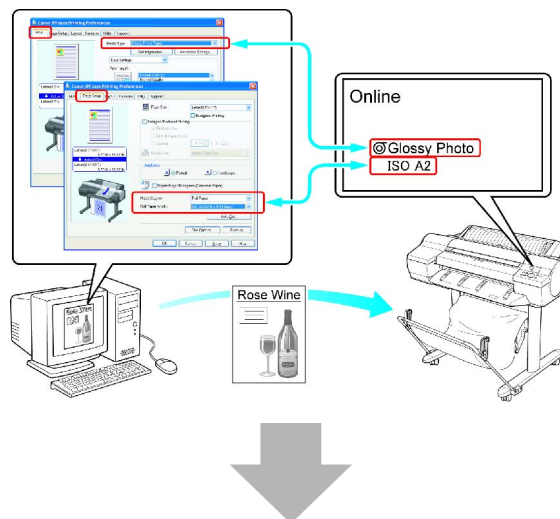

8. Start printing.

- Printing from Windows (→P.88)
- Printing from Mac OS X (→P.89)
- Printing from Mac OS 9 (→P.91)



Note

- Steps 5 and 6 are not required, if a barcode has been printed on the roll and you have activated automatic detection of the remaining roll paper. The paper type and amount of paper left are automatically detected.
- Keeping a roll in the printer for a long time without printing on it may leave a depression on the leading edge.
When printing quality is most important, we recommend setting **TrimEdge Reload** to **On** or **Automatic** so that the paper edge is automatically cut before printing.
- For details on supported sizes and types of the roll that can be loaded, see Paper Sizes (→P.113) or the Paper Reference Guide. (→P.108)
- Clean the platen after you have used up a roll. (→P.640)
- When a roll has been advanced, do not pull it out by force. This will prevent the paper from being advanced.
If you accidentally pull out the paper, hold the **Load/Eject** button to enable feeding again. (→P.122)
- When printing on rolls after printing on sheets, if the lit paper selection lamp does not switch from the **Cut Sheet lamp** to the **Roll Media lamp**, press the **Feeder Selection** button.

☐ Loading and Printing on Sheets in the Paper Feed Slot

These are the basic steps for loading sheets in the paper feed slot and then printing from this slot. Follow the steps below to load and print on sheets in the paper feed slot.



Note

- If a roll is loaded, rewind the roll before this procedure. (→P.146)

1. Turn the printer on. (→P.19)

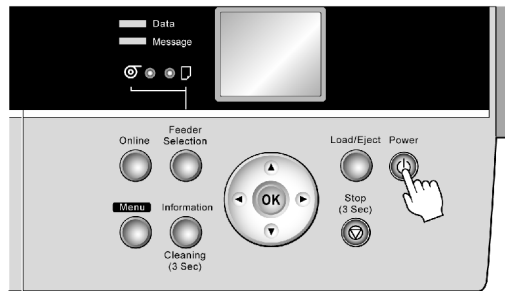

2. Complete settings in the printer driver for the type and size of paper and other details.

- Specifying Paper in the Printer Driver (Windows) (→P.93)
- Specifying Paper in the Printer Driver (Mac OS X) (→P.95)
- Specifying Paper in the Printer Driver (Mac OS 9) (→P.97)

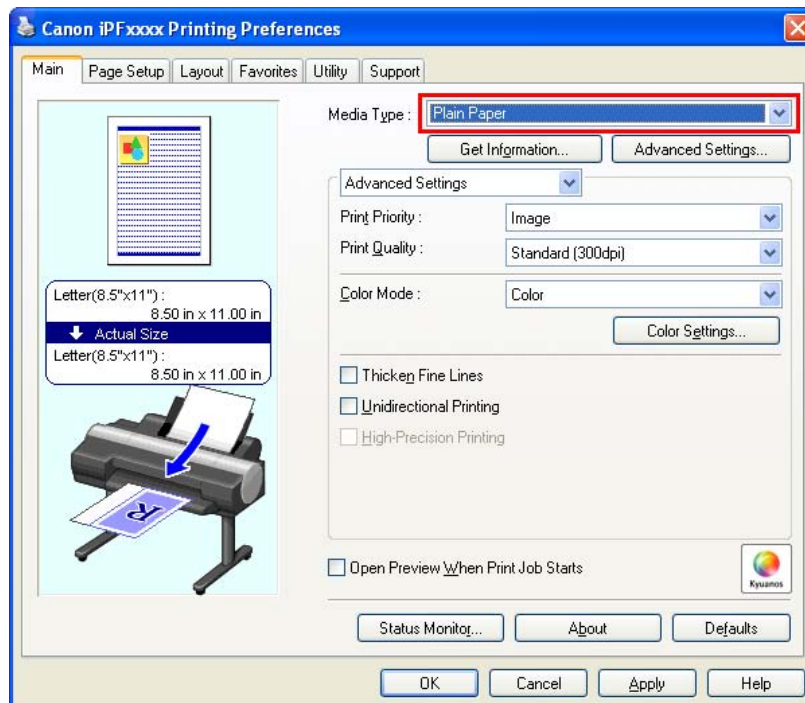

3. Send the print job.

- Printing from Windows (→P.88)
- Printing from Mac OS X (→P.89)
- Printing from Mac OS 9 (→P.91)

4. Load sheets manually. (→P.156)

(Top Paper Feed Slot)

(Front Paper Feed Slot)



Note

- If you will load a sheet before sending a print job, you must select the type and size of paper in advance on the printer Display Screen. Follow these steps.
 - Selecting the Paper Type (Sheet) (→P.162)
 - Selecting the Paper Size (Sheet) (→P.163)

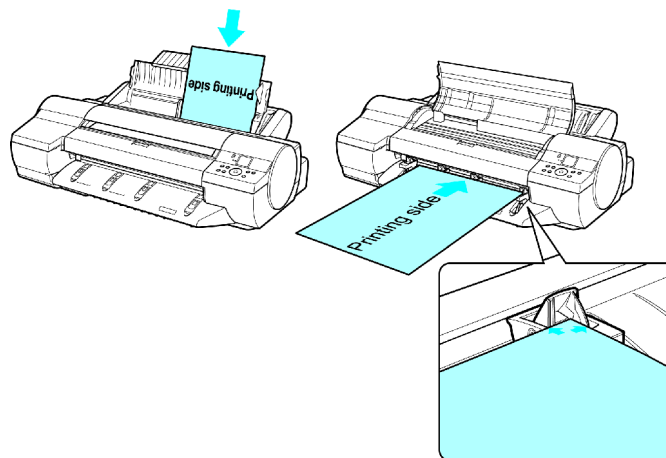

Start printing.



Note

- For details on supported sizes and types of the paper that can be loaded in the tray, see Paper Sizes (→P.113) or the Paper Reference Guide. (→P.108)

Printing Options Using Rolls and Sheets

The printer supports both rolls and sheets. Take advantage of each type of paper for a wide range of printing applications.

Rolls and Sheets

- Media in spooled rolls is generally called Roll Media.
Rolls can be used to print large photos or create posters or banners that cannot be printed on regular sheets.
- Sheets refers to individual sheets of paper in regular sizes.
Sheets are loaded in the Top Paper Feed Slot.
Heavyweight paper is loaded in the Front Paper Feed Slot.

Paper Size

- Page Size: The size of the image to be printed, as specified in the application.
- Paper Size (also called Media Size):
 - In the case of sheets, paper size refers to the actual size of the paper loaded in the printer.
 - In the case of rolls, paper size is an imagined size set as the printing area for a single page.

Printing Options Using Rolls and Sheets

Printing Method	Rolls
Large-Format Printing	Easily print vertical or horizontal banners from familiar applications such as Microsoft Office applications. Print banners up to 18 m (19.69 yd) long.
Borderless Printing	Print without a margin (border) around posters or photos.
Free Layout (Windows)	Print multiple documents from multiple applications (such as word-processing programs, spreadsheet programs, and so on) next to each other.
Free Layout (Macintosh)	
Banner Printing	Print pages of a multi-page document consecutively without blank space between pages.



Important

- If you use an A1 or A2 roll for borderless printing, be sure to attach the provided Spacer for Borderless Printing on the Roll Holder. If you print without attaching it, the Platen may be soiled, which may cause ink to adhere to the unprinted side of the paper. (→P.144)

Printing from Windows

Print from the application software menu.



Important

- The Windows printer driver can be used in the following versions of Windows:
 - Windows 2000 (Professional or Server)
 - Windows XP (Home Edition or Professional)
 - Windows Server 2003 (Standard Edition)
 - Windows Vista
- We recommend exiting unnecessary applications before printing. Running several applications while printing may interrupt the transfer of print data and affect printing quality.

1. In the application software, select **Print** from the **File** menu to display the dialog box for printing conditions.
2. After confirming that the printer is selected in the dialog box, click **Print** or **OK** to start printing.



Note

- The appearance of the dialog box varies depending on the application software. In most cases, the dialog box includes basic printing options and enables you to choose the printer, specify the range of pages, number of copies, and so on.

Example: Print dialog box displayed by the application software

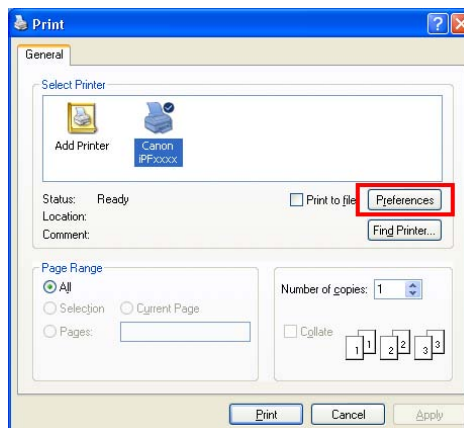

Note

- If another printer is selected, select the printer you want to use under **Select Printer** or in the dialog box displayed after clicking **Printer**.

Settings for many printing methods (including enlarged or reduced printing, borderless printing, and so on) are displayed in the printer driver dialog box. There are two ways to access the printer driver dialog box, as follows:

- From the application software
(→P.473)
- From the operating system menu
(→P.149)

Printing from Mac OS X

Print from the application menu after registering the printer.



Important

- We recommend exiting unnecessary applications before printing. Running several applications while printing may interrupt the transfer of print data and affect printing quality.

Registering the printer

Before printing, you must register the printer in **Printer Setup Utility** (or **Print Center**).

For instructions on registering the printer, see “Configuring the Printer Driver Destination (Macintosh)”. (→P.573)



Important

- During this setup process, the printer will not be listed among available printers if it is off or disconnected.
- By factory default, the AppleTalk protocol is disabled on the printer. You must enable the AppleTalk protocol before using the printer in an AppleTalk network. For instructions on activating AppleTalk protocol, see “Configuring the Destination for AppleTalk Network (Macintosh)”. (→P.574)



Note

- When registering the printer, choose **USB** if the printer is connected via USB, **Canon FireWire(iPF)** if connected via IEEE 1394, or **AppleTalk**, **Canon IP(iPF)**, or **Bonjour** if connected via a network.
- For **Canon IP(iPF)** connections, enter the printer’s IP address.

Printing from the application software

1. In the application software, select **Print** from the **File** menu to display the dialog box for printing conditions.



Note

- This dialog box includes basic printing options and enables you to choose the printer, specify the range of pages, number of copies, and so on.

2. Select the printer in the **Printer** list.

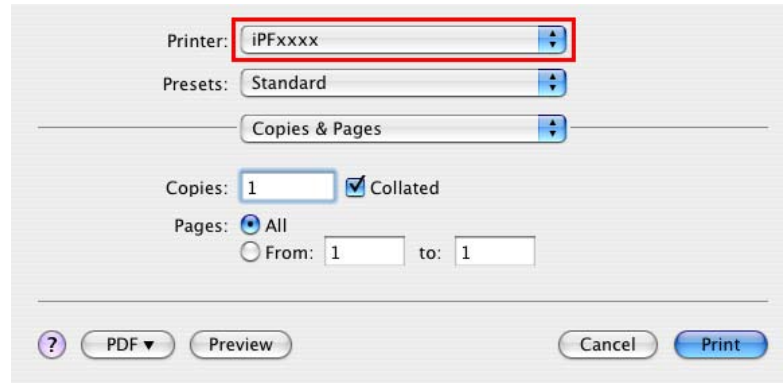

3. Click **Print** to start printing.

As shown in the following illustration, you can switch to other panes in this dialog box to complete settings for various methods of printing, including enlarged and reduced printing, borderless printing, and so on.

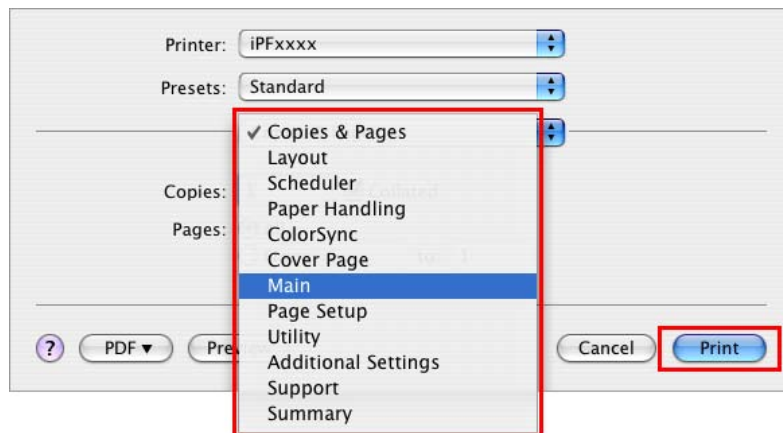

Printing from Mac OS 9

After selecting the printer in **Chooser** from the Apple menu, print by using menus in the application software.



Important

- We recommend exiting unnecessary applications before printing. Running several applications while printing may interrupt the transfer of print data and affect printing quality.

Selecting the printer

Before printing, you must confirm that the printer is selected in **Chooser**.

For instructions on selecting the printer, see “Configuring the Printer Driver Destination (Macintosh)”. (→P.573)



Important

- During this setup process, the printer will not be listed in **Chooser** if it is off or disconnected.
- By factory default, the AppleTalk protocol is disabled on the printer. You must enable the AppleTalk protocol before using the printer in AppleTalk network. For instructions on activating AppleTalk protocol, see “Configuring the Destination for AppleTalk Network (Macintosh)”. (→P.574)



Note

- In **Chooser**, choose **GARO Printer Driver**.
- In **Destination**, choose **USB** if the printer is connected via USB, **FireWire** if connected via IEEE 1394, or **AppleTalk**, **IP Print**, or **IP Print (Auto)** if connected via network.
- If the printer is connected via **AppleTalk**, click **Active** under **AppleTalk** in the lower-right corner of the **Chooser** window.
- If the printer is connected via **IP Print**, click **Registering IP Address** under the **Destination** list to register the printer’s IP address, and then click **IP Print**.

Printing from the application software

1. In the application software, select **Print** from the **File** menu to display the dialog box for printing conditions.



Note

- This dialog box includes basic printing options for the range of pages, number of copies, and so on. You can also specify enlargement or reduction, borderless printing, and a variety of other print settings.

2. Make sure the printer is selected in the **Printer** list.

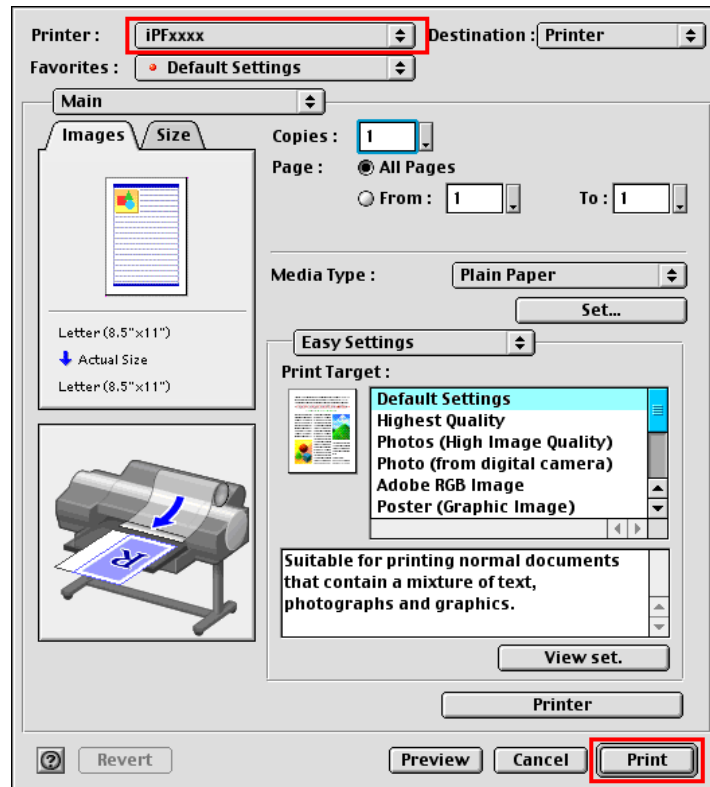

3. Click **Print** to start printing.

Specifying Paper in the Printer Driver (Windows)

If you have replaced the paper, you must complete the following settings in the printer driver.



Important

- Always specify the same type and size of paper in the printer menu and printer driver.
If the type and size do not match, an error message will be displayed and printing is not possible.

1. Choose **Print** in the application menu.
2. Select the printer in the dialog box, and then display the printer driver dialog box. (→P.473)
3. Make sure the **Main** sheet is displayed.

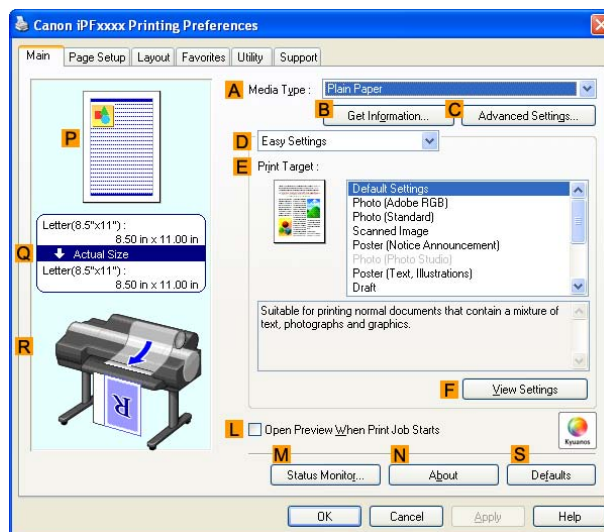

4. In the **A Media Type** list, select the type of paper that is loaded.
5. Click the **Page Setup** tab to display the **Page Setup** sheet.

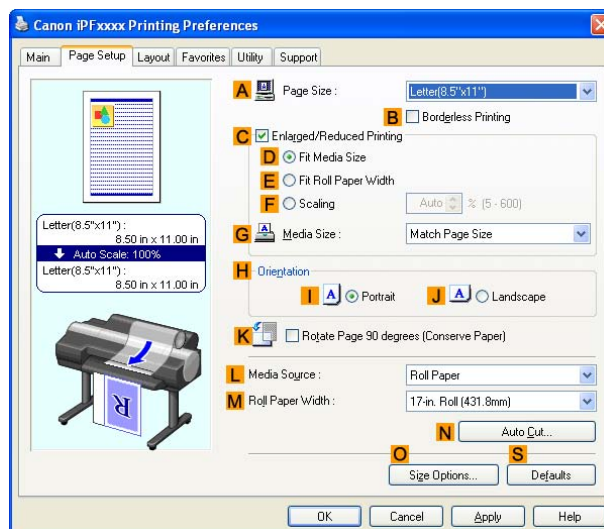

6. In the **A Page Size** list, select the size of the original as specified in the application.
7. In the **L Media Source** list, select how paper is supplied.

8. If you have selected **Roll Paper** in **L Media Source**, select the width of the loaded roll in **M Roll Paper Width**.



Note

- A variety of settings are available in the printer driver to suit different printing applications. For details on available printing conditions, see “Printer Driver Settings (Windows)”. (→P.441)

Specifying Paper in the Printer Driver (Mac OS X)

If you have replaced the paper, you must complete the following settings in the printer driver.

1. Choose **Page Setup** from the application menu to display the **Page Attribute** dialog box.

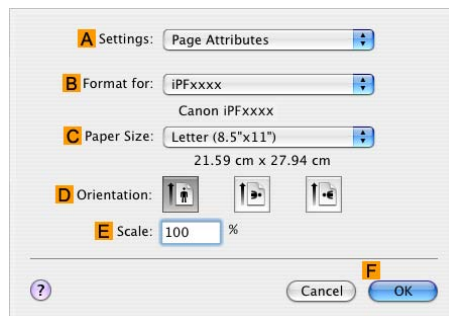

2. Select the printer in the **B Format for** list.
3. Choose the original size in the **C Paper Size** list.
4. Click **F OK** to close the dialog box.
5. Choose **Print** in the application menu.
6. Access the **Main** pane.

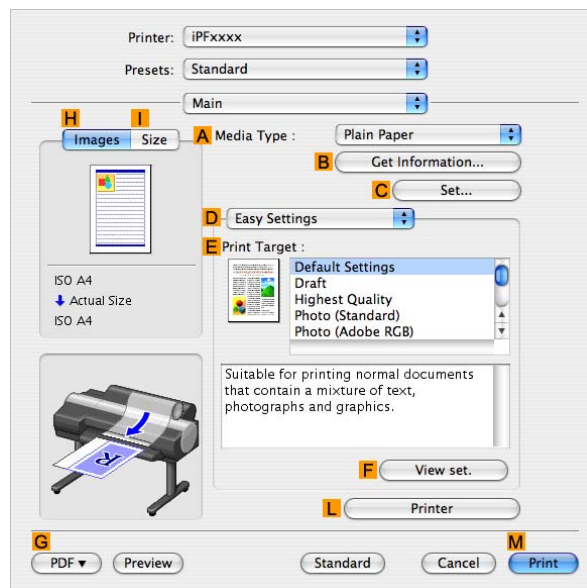

7. In the **A Media Type** list, select the type of paper that is loaded.

8. Access the **Page Setup** pane.

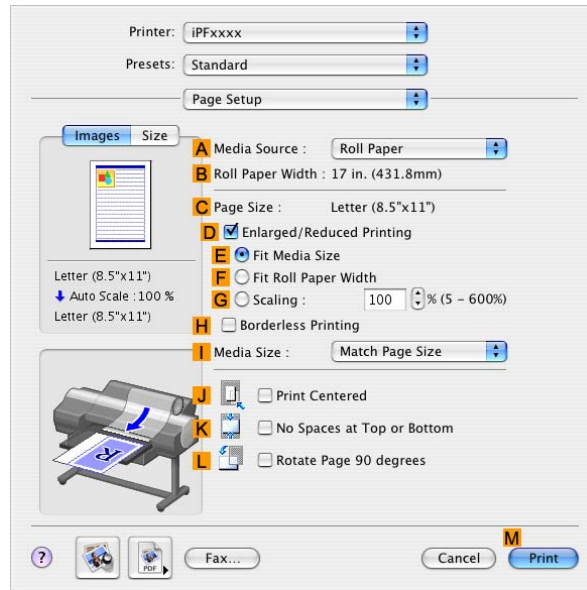

9. In the **A Media Source** list, select how paper is supplied.

10. If you have selected **Cut Sheet** or **Manual** in **A Media Source**, make sure the size as selected in **Page Setup** is displayed in **C Page Size**. If you have selected **Roll Paper** in **A Media Source**, make sure the width of the loaded roll is displayed in **B Roll Paper Width**.



Note

- If the width of the roll loaded in the printer is not shown in **B Roll Paper Width**, click **L Printer Information** on the **Main** pane to update the printer information.

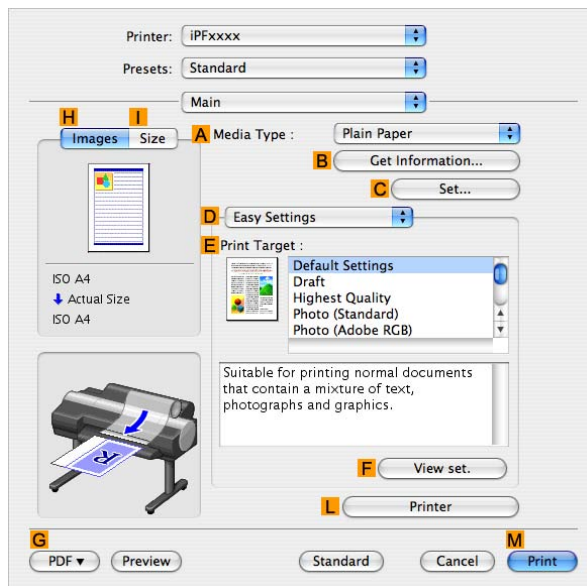

Note

- A variety of settings are available in the printer driver to suit different printing applications. For details on available printing conditions, see "Printer Driver Settings (Mac OS X)". (→P.492)

■ Specifying Paper in the Printer Driver (Mac OS 9)

If you have replaced the paper, you must complete the following settings in the printer driver.

1. Select the printer in **Chooser**.
2. Choose **Page Setup** from the application menu to display the **Page Attribute** dialog box.

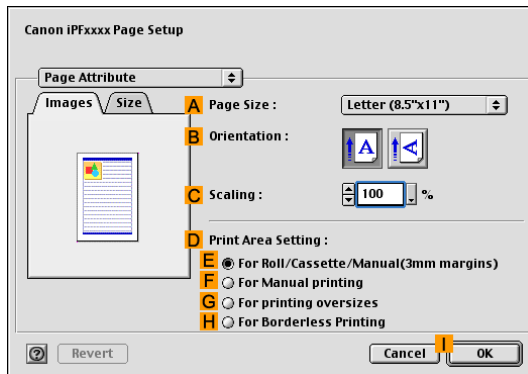

3. Choose the original size in the **A Page Size** list.
4. Click **I OK** to close the dialog box.
5. Choose **Print** in the application menu.
6. Make sure the **Main** pane is displayed.

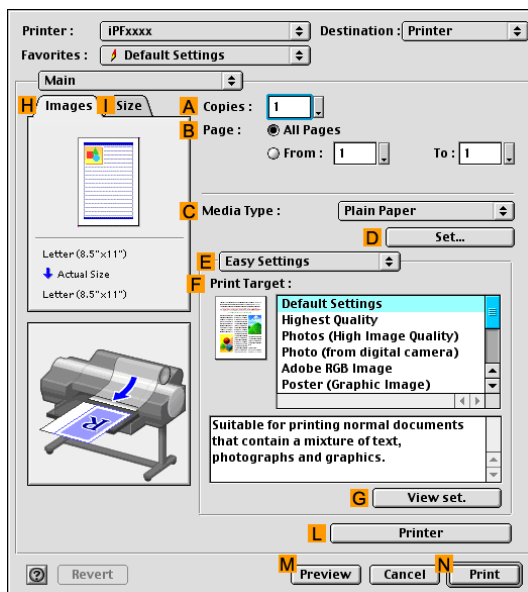

7. In the **C Media Type** list, select the type of paper that is loaded.

8. Access the **Finishing** pane.

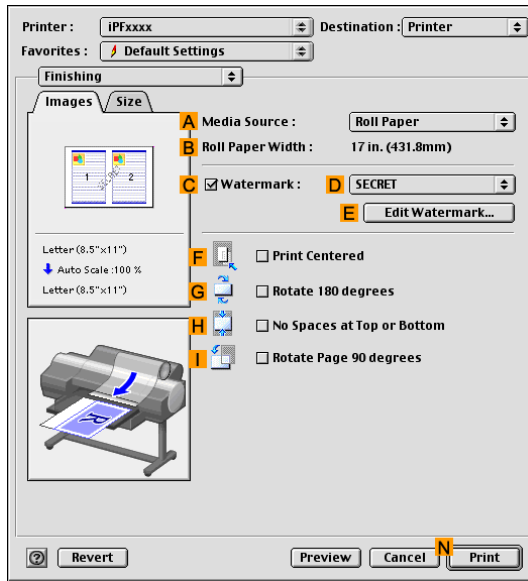

9. In the **A Media Source** list, select how paper is supplied.

10. If you have selected **Roll Paper** in **A Media Source**, make sure the width of the loaded roll is displayed in **B Roll Paper Width**.



Note

- If the width of the roll loaded in the printer is not shown in **B Roll Paper Width**, click **L Printer Information** on the **Main** pane to update the printer information.

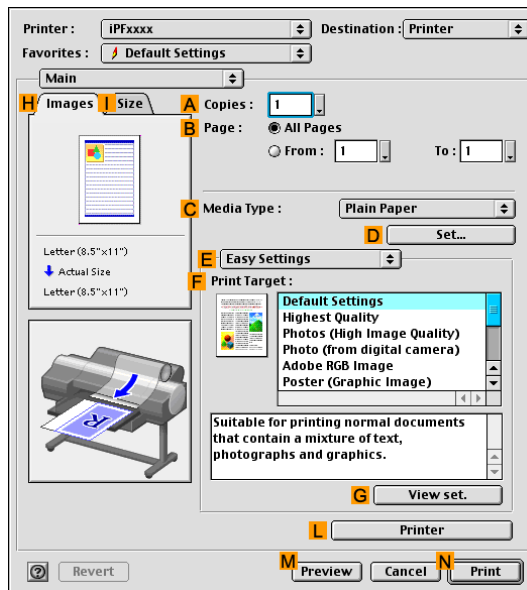

Note

- A variety of settings are available in the printer driver to suit different printing applications. For details on available printing conditions, see "Printer Driver Settings (Mac OS 9)". (→P.517)

Canceling print jobs

Canceling Print Jobs from the Control Panel

Hold down the **Stop** button for a second or more to cancel print jobs or ink drying in progress when the printer is online, offline, or in Menu mode.

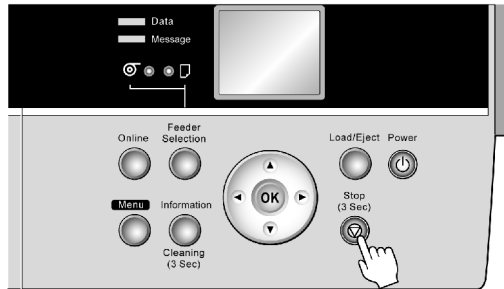

Printer operation varies depending on the status when you hold down the **Stop** button for a second or more during printing.

- If you press the **Stop** button before printing starts
Holding down the **Stop** button for a second or more before printing cancels the print job and brings the printer online.
When the roll is selected as the paper source, the printer goes online, and when sheet is selected, the printer goes offline.

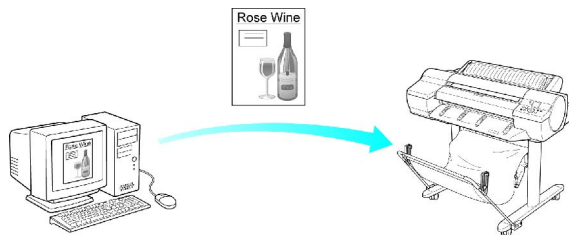

The Printer does not print.

- If you press the **Stop** button during printing
Holding down the **Stop** button for a second or more during printing stops printing immediately.

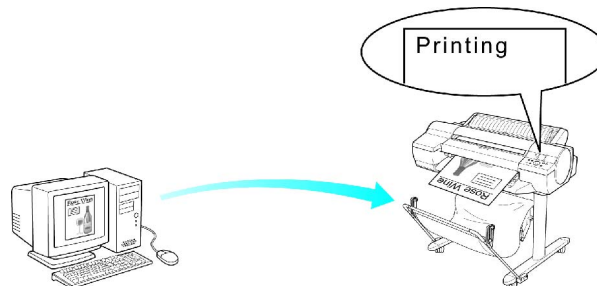

The printer stops immediately.

Canceling print jobs

- If you press the **Stop** button when printing is paused
Holding down the **Stop** button for a second or more when printing is paused cancels the print job.

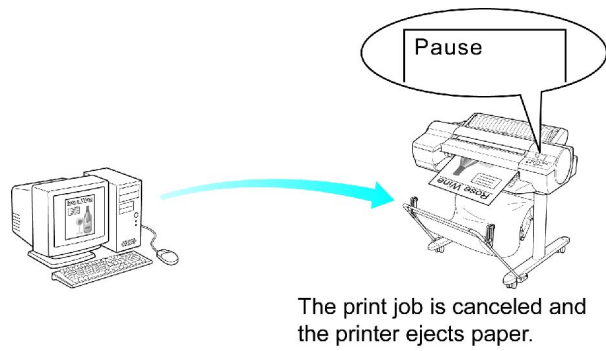

Canceling Print Jobs from Windows

You can cancel print jobs in the printer window.

1. Click the printer icon in the taskbar to display the printer window.



Note

- You can also display this window by double-clicking the printer icon in the **Printers and Faxes** (or **Printers**) folder, accessible through the Windows **start** menu.

2. Choose **Cancel All Documents** in the **Printer** menu to stop the print processing.

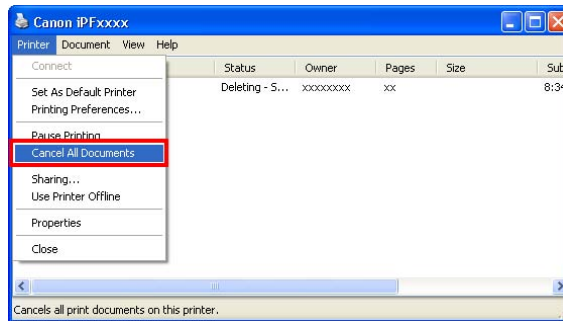

To cancel print jobs from the Control Panel, follow these steps.

1. If the Display Screen of the Control Panel still indicates that the job is in progress and the **Data lamp** continues flashing, hold down the **Stop** button for a second or more to stop printing.

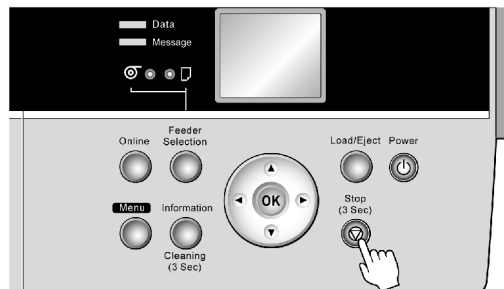

Canceling print jobs

Do the following if no print jobs are shown in the printer window (because they have already been sent to the printer).

1. Double-click the taskbar icon to access the imagePROGRAF Status Monitor.
2. On the **Printer Status** sheet, click **Cancel Job**.

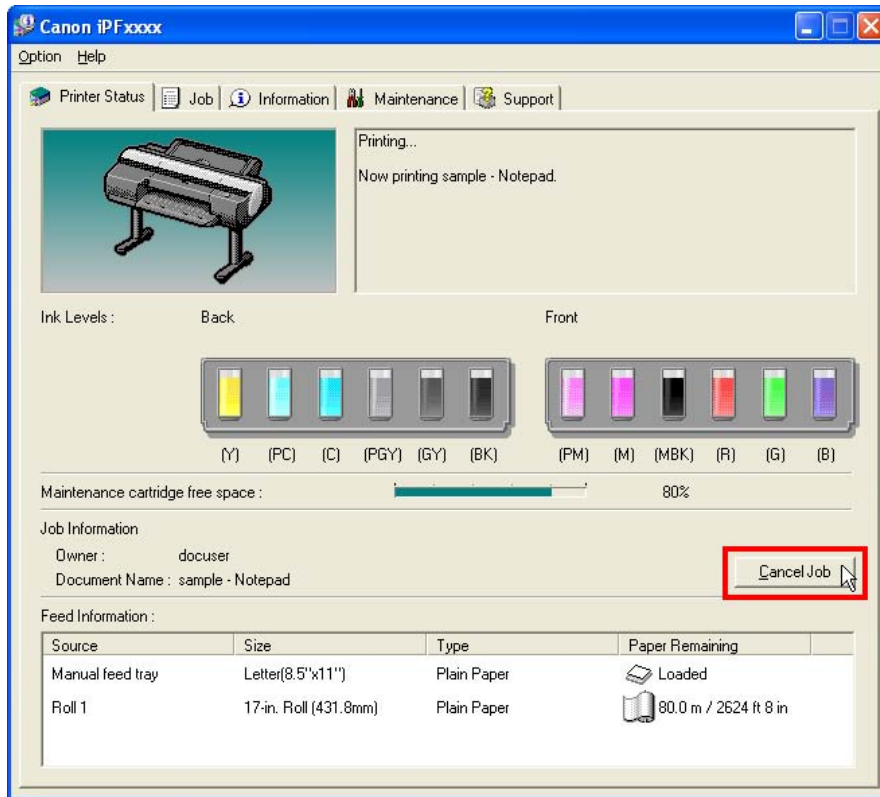

Canceling Print Jobs from Mac OS X

You can cancel print jobs in **imagePROGRAF Printmonitor**.

1. Click the printer icon in the **Dock** to display the printer window.
2. Click **Stop Jobs** to stop printing.

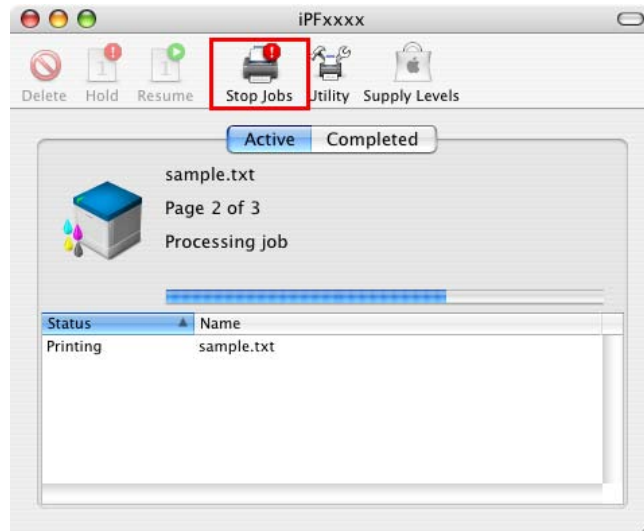

In this window, you can cancel jobs sent to the printer.



Note

- The print job is displayed on the printer's screen during the transmission of print data from the computer. When the transmission is completed, the job is not displayed even during printing.

3. Click **Utility** to display **imagePROGRAF Printmonitor**.

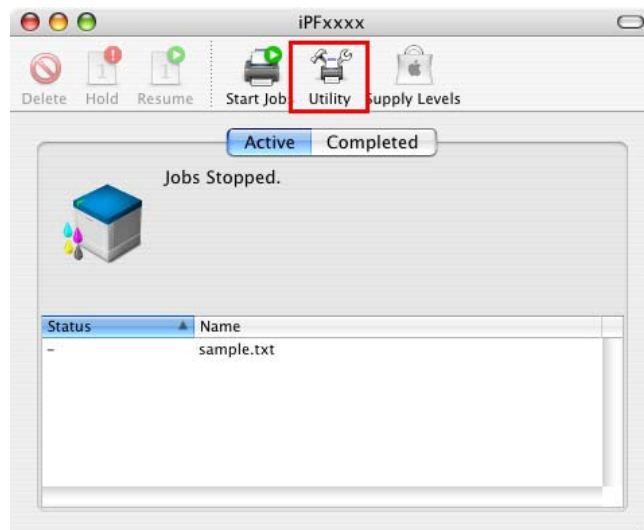

4. Select the print job to cancel and click the **Cancel Job** button to remove the print job.

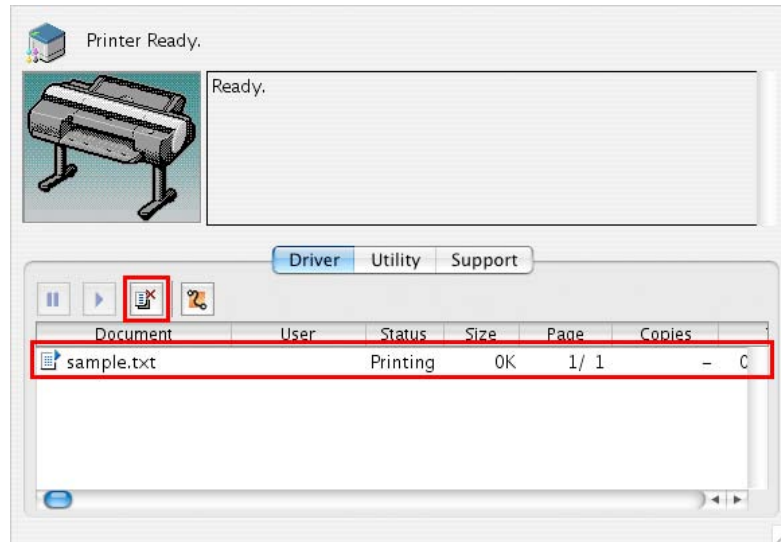

The job sent to the printer is canceled.



Note

- The print job is displayed on the **imagePROGRAF Printmonitor** window while the printer receives the print data from the computer. It is not displayed before transmission of print data to the printer, even if the computer has started the process of the data.

5. Exit **imagePROGRAF Printmonitor**. In the printer window, click **Start Jobs**.



Important

- Always follow these steps if you cancel print jobs. If you do not restart job processing, the next job cannot be printed.

To cancel print jobs from the Control Panel, follow these steps.

1. If the Display Screen of the Control Panel still indicates that the job is in progress and the **Data lamp** continues flashing, hold down the **Stop** button for a second or more to stop printing.

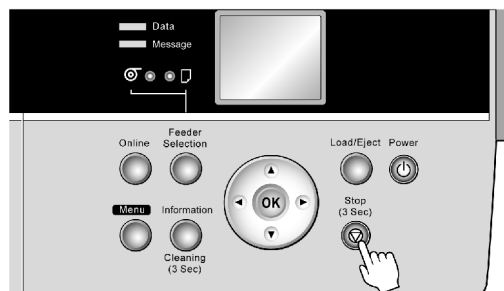

Canceling Print Jobs from Mac OS 9

How to cancel print jobs varies depending on whether you are printing in the foreground or background.

Canceling background print jobs

1. Open the **Garo Printer Extra** folder, which was installed on the hard disk at the same time as the printer driver.
2. Open **imagePROGRAF Printmonitor**.
3. Choose **Pause Printing** in the **File** menu to stop print processing.



The job status changes from **Sending** to **Send**.

4. Select the print job to cancel and click the **Cancel Job** button to remove the print job.

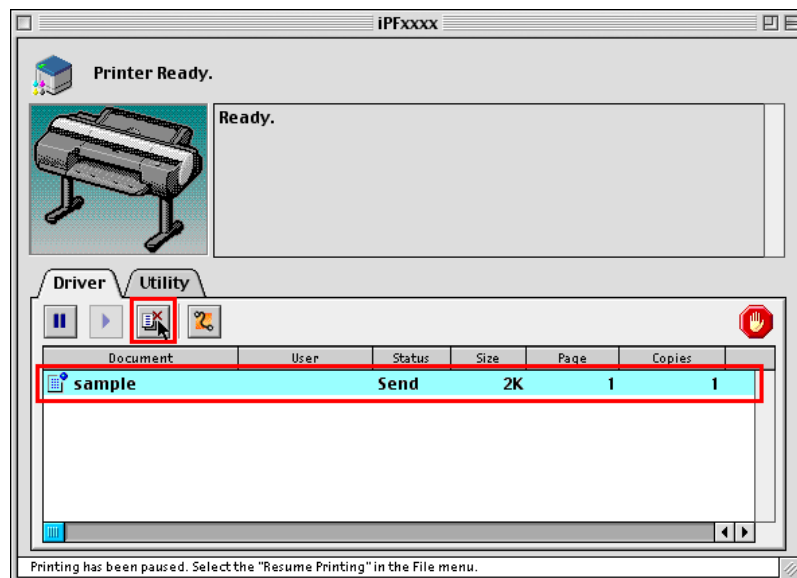

5. Choose **Resume Printing** in the **File** menu.



Important

- Always follow these steps if you cancel print jobs. If you do not restart the print queue, the next job cannot be printed.

Canceling print jobs

To cancel print jobs from the Control Panel, follow these steps.

1. If the Display Screen of the Control Panel still indicates that the job is in progress and the **Data lamp** continues flashing, hold down the **Stop** button for a second or more to stop printing.

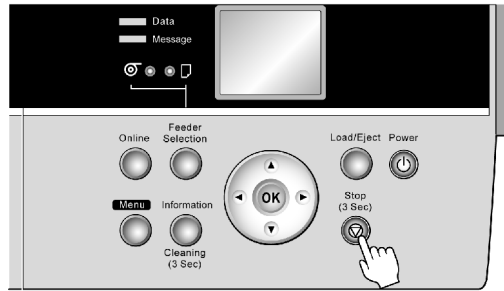

Canceling foreground print jobs

1. When the progress indicator is displayed, hold down the Command key and press the period (.) key to cancel print jobs.
2. If the Display Screen of the Control Panel still indicates that the job is in progress and the **Data lamp** continues flashing, hold down the **Stop** button for a second or more to stop printing.

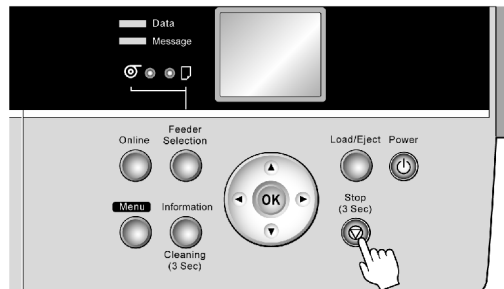

Handling Paper

Paper

■ Paper

The printer supports the following types of paper.

Paper Type

For information on the types of paper the printer supports, refer to the Paper Reference Guide. (→P.108)

Paper Size

Roll	Paper width	203-610 mm (8-24 in)
	Outer diameter	Up to 150 mm (6 in)
	Inner diameter of paper core	2 or 3 inches
	Printing surface	Top (outside)
Sheets		203 × 279 mm to 610 × 1,600 mm (8.0 × 11.0 in to 24.0 × 63.0 in)



Note

- Paper quality varies among manufacturers. Before buying paper, contact the Canon dealer where you purchased the printer.

Types of Paper

For information on the types of paper the printer supports, refer to the Paper Reference Guide . This guide identifies supported plain paper, coated paper, photo paper (such as glossy photo paper), proofing paper, CAD paper, and other types of paper. The Paper Reference Guide identifies types and specifications of paper, as well as information on printer driver settings and tips on handling paper.

You can update paper information in the Paper Reference Guide , on the printer Control Panel, and in the printer driver by downloading the latest version of the Media Configuration Tool from the imagePROGRAF website.



Note

- The media types with "†" marked in the product name are those specified as genuine Canon media. For other media, please contact the respective media manufacturer after reading the instruction manuals supplied with the media.

Viewing the Paper Reference Guide

You can access the Paper Reference Guide as follows. Follow the steps for your particular operating system.

- Windows
 1. Double-click the **iPFxxxx Support** icon on the desktop. (Here, iPFxxxx represents the printer model.)



The online support window is displayed.

2. Select **Paper Reference Guide**.

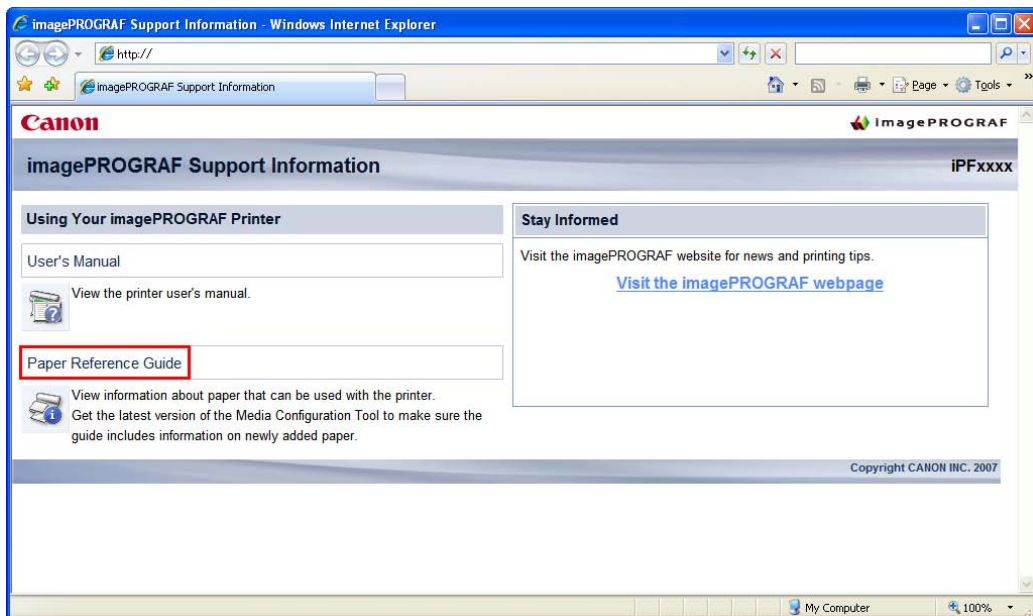

The Paper Reference Guide is displayed.

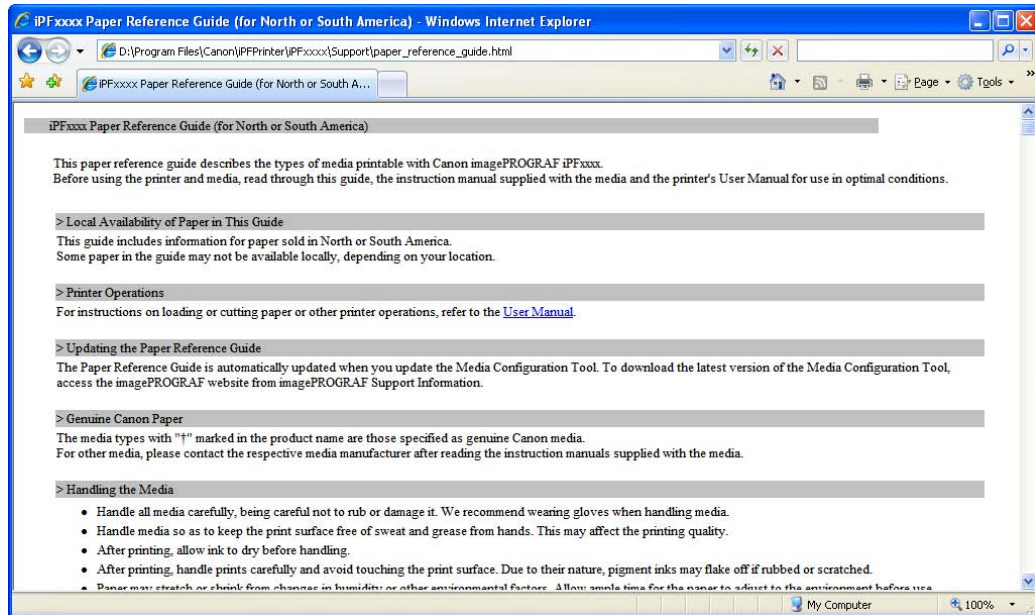

- Mac OS X

1. Click the **iPF Support** icon in the **Dock**.



The online support window is displayed.

2. Select **Paper Reference Guide**.

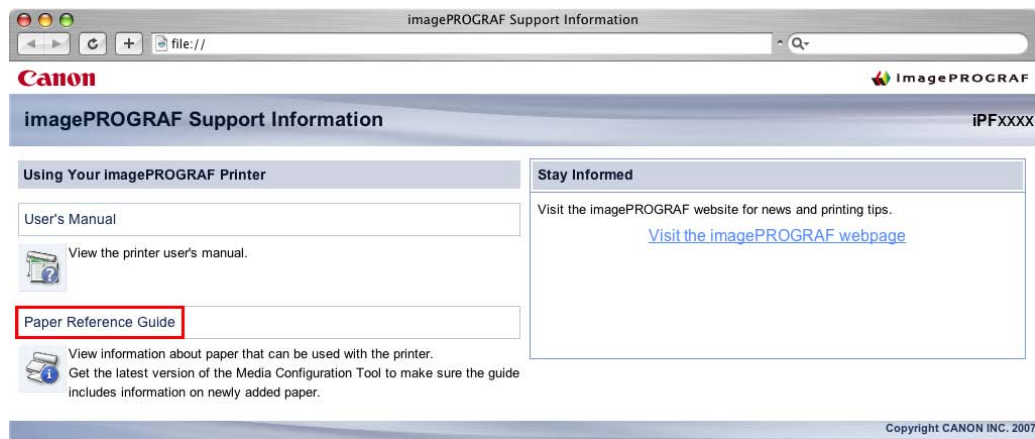

The Paper Reference Guide is displayed.

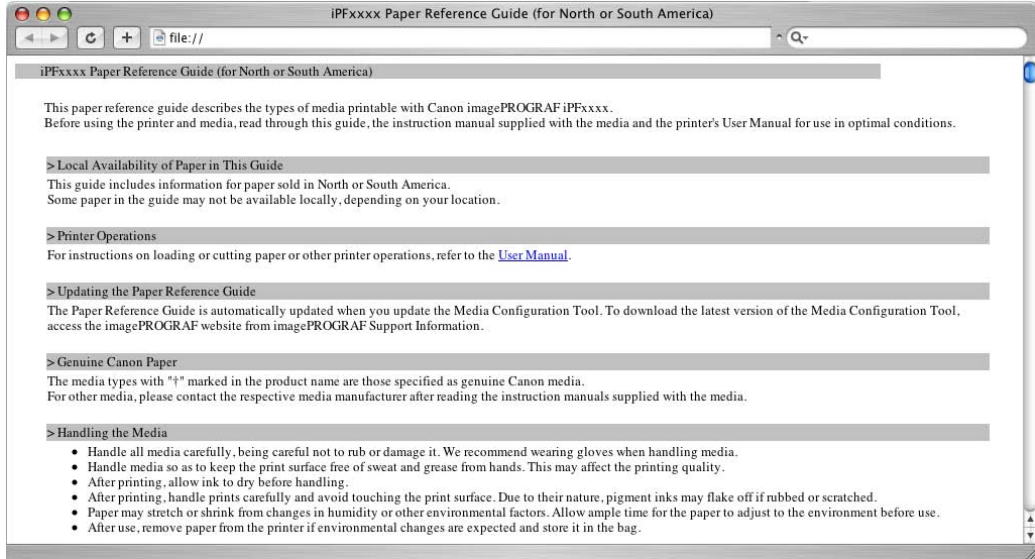

- Mac OS 9

1. Double-click the **iPFxxxx Paper Reference Guide** icon on the desktop. (Here, iPFxxxx represents the printer model.)



The Paper Reference Guide is displayed.

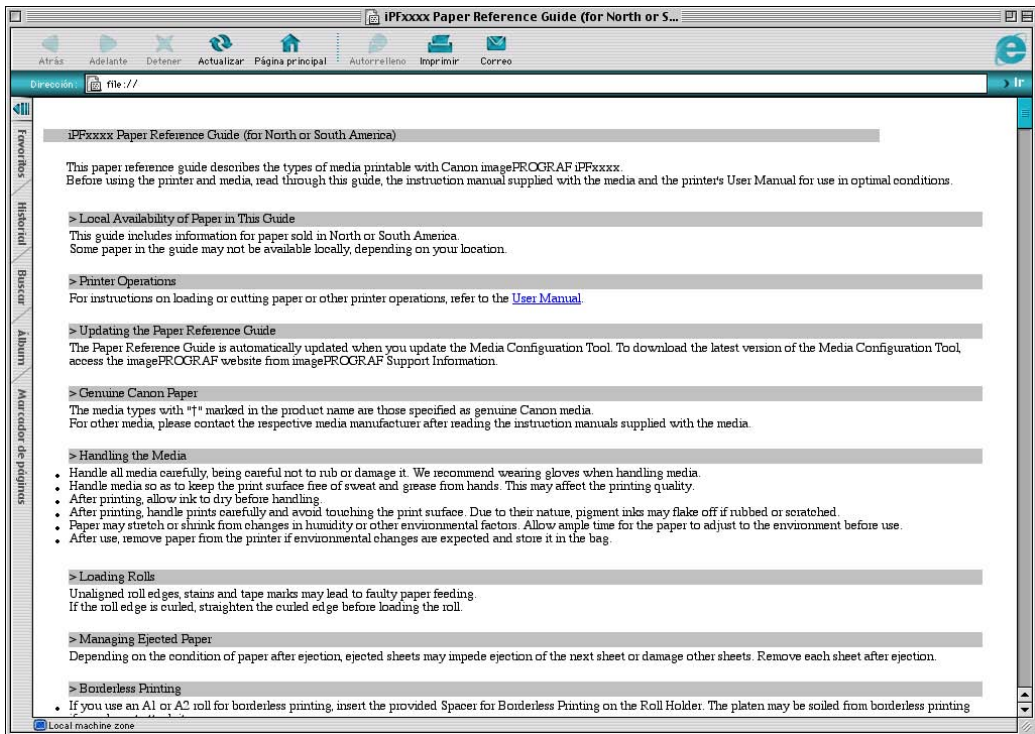

Updating paper information

You can update paper information in the Paper Reference Guide and on the printer by downloading the latest version of the Media Configuration Tool from the imagePROGRAF website. For information about the Media Configuration Tool, see the Media Configuration Tool Guide (Windows) or Media Configuration Tool Guide (Macintosh).

Follow these steps to access the imagePROGRAF website.



Important

- When you update paper information by using the Media Configuration Tool, the paper type setting on the Control Panel, in the printer driver, and in related software is updated.
- Windows
 1. Double-click the **iPFxxxx Support** icon on the desktop. (Here, iPFxxxx represents the printer model.)



The online support window is displayed.

2. Select **Stay Informed**.

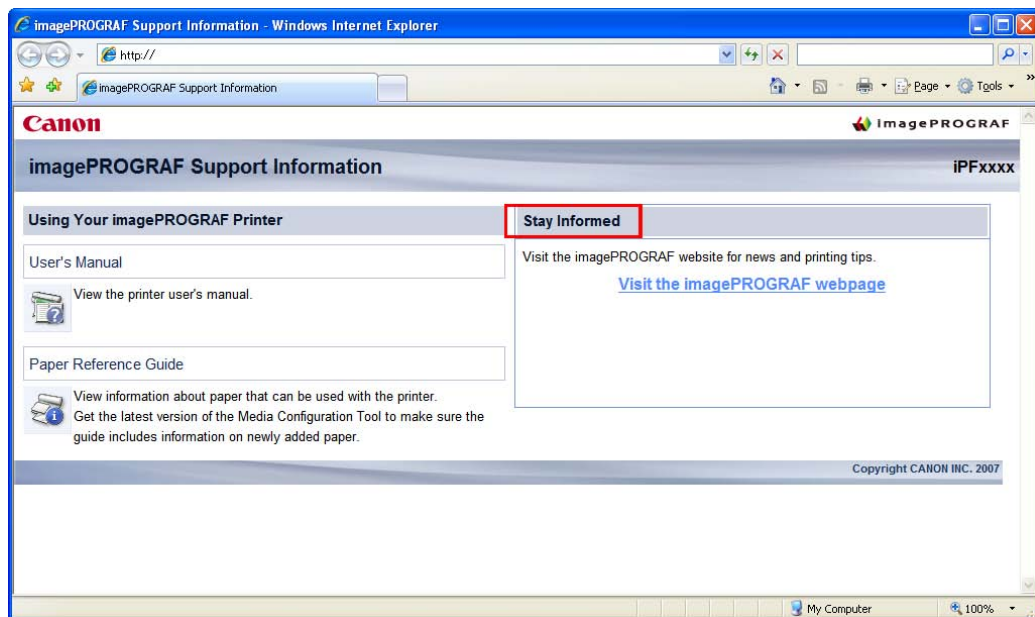

The default browser is started, and the imagePROGRAF webpage is displayed.

- Mac OS X

1. Click the **iPF Support** icon in the **Dock**.



The online support window is displayed.

2. Select **Stay Informed**.

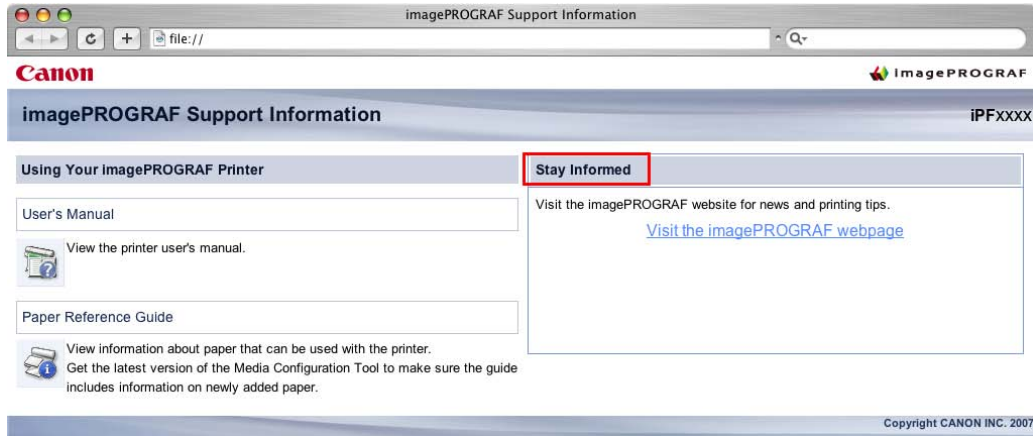

The default browser is started, and the imagePROGRAF webpage is displayed.



Note

- In Windows, you can also access the imagePROGRAF webpage by clicking the **start** menu, selecting **Programs** > iPFxxxx Media Configuration Tool (here, iPFxxxx represents the printer model) > iPFxxxx Media Configuration Tool to start the Media Configuration Tool, and clicking Extra Information.
- On a Macintosh computer, you can also access the imagePROGRAF website from the Finder by selecting Applications (in Mac OS X or OS 9) > Canon Utilities > iPFxxxx Media Configuration Tool (here, iPFxxxx represents the printer model) > MCTxxxx to start the Media Configuration Tool and then clicking Extra Information.

Paper Sizes

You can use the following sizes of paper.

Sheets

You can use sheets in the following sizes, up to 610 mm (24 in) wide.

Paper Size	Dimensions	Feeding from Cassette
ISO A1	594 × 841 mm (23 × 33 in)	No
ISO A2	420 × 594 mm (16.5 × 23 in)	Yes
ISO A2+	432 × 610 mm (17 × 24 in)	No
ISO A3	297 × 420 mm (12 × 17 in)	Yes
ISO A3+	329 × 483 mm (13 × 19 in)	Yes
ISO A4	210 × 297 mm (8 × 12 in)	Yes
ISO B2	500 × 707 mm (20 × 28 in)	No
ISO B3	353 × 500 mm (14 × 20 in)	No
ISO B4	250 × 353 mm (10 × 14 in)	No
JIS B2	515 × 728 mm (20 × 29 in)	No
JIS B3	364 × 515 mm (14 × 20 in)	Yes
JIS B4	257 × 364 mm (10 × 14 in)	Yes
22"x34"(ANSI D)	559 × 864 mm (22 × 34 in)	No
17"x22"(ANSI C)	432 × 559 mm (17 × 22 in)	Yes
11"x17" (Ledger)	279 × 432 mm (11 × 17 in)	Yes
13"x19" (Super B)	330 × 483 mm (13 × 19 in)	Yes
Letter (8.5"x11")	216 × 279 mm (9 × 11 in)	Yes
Legal (8.5"x14")	216 × 356 mm (9 × 14 in)	Yes
24"x36" (ARCH D)	610 × 914 mm (24 × 36 in)	No
18"x24" (ARCH C)	457 × 610 mm (18 × 24 in)	No
12"x18" (ARCH B)	305 × 457 mm (12 × 18 in)	Yes
9"x12" (ARCH A)	229 × 305 mm (9 × 12 in)	No
DIN C2	458 × 648 mm (18 × 26 in)	No
DIN C3	324 × 458 mm (13 × 18 in)	No
DIN C4	229 × 324 mm (9 × 13 in)	No
20"x24"	508 × 610 mm (20 × 24 in)	No
18"x22"	457 × 559 mm (18 × 22 in)	No
14"x17"	355 × 432 mm (14 × 17 in)	Yes
12"x16"	304 × 406 mm (12 × 16 in)	Yes
10"x12"	254 × 305 mm (10 × 12 in)	Yes
10"x15"	254 × 381 mm (10 × 15 in)	Yes

Paper Size		Dimensions	Feeding from Cassette
US Photo 16"x20"		406 × 508 mm (16 × 20 in)	Yes
Poster 20"x30"		508 × 762 mm (20 × 30 in)	No
13"x22"		329 × 558 mm (13 × 22 in)	Yes
Poster 300x900mm		300 × 900 mm (12 × 35 in)	No
Custom Media Size	Top Paper Feed Slot	203 × 279 mm (8 × 11 in) - 610 × 1600 mm (24 × 63 in)	No
	Front Paper Feed Slot	203 × 520 mm (8 × 21 in) - 610 × 914 mm (24 × 36 in)	No

Rolls

Rolls that meet the following conditions are supported.

- Outer diameter: up to 150 mm (6 in)
- Inner diameter of paper core: 2 or 3 inches
- Printing side out

Identification in Roll Paper Width in Printer Driver (*1)	Borderless Printing (*1)
24-in. Roll (610mm)	Yes
ISO A1/A2 Roll (594mm)	Yes (*2)
JIS B2/B3 Roll (515mm)	Yes
17-in. Roll (432mm)	Yes
ISO A2/A3 Roll (420mm)	Yes (*2)
16-in. Roll (407mm)	Yes
14-in. Roll (356mm)	Yes
A3+ Roll (329mm)	Yes
300mm Roll (300mm)	No
ISO A3/A4 Roll (297mm)	No
JIS B4 Roll (257mm)	Yes
10-in. Roll (254mm)	Yes
8-in. Roll (203mm)	No

*1: For information on types of paper compatible with borderless printing, refer to the Paper Reference Guide (→P.108)

*2: Requires the Spacer for Borderless Printing.



Note

- In the printer driver, paper sizes are categorized into groups based on the “size system,” such as ISO A and JIS. In Windows and Mac OS 9, some size systems are not available by default.
- For details on non-standard **Custom Media Size**, see “Printing on Non-Standard Paper Sizes”. (→P.331)
- Borderless printing is not supported on sheets.

Handling rolls

☐ Selecting the Roll as the Paper Source

You can switch the paper source between the roll and the sheet by pressing the **Feeder Selection** button. Each time you press this button, the paper source switches between the roll (indicated by the **Roll Media lamp**) and the sheet (indicated by the **Cut Sheet lamp**).

Press the **Feeder Selection** button to activate the **Roll Media lamp** (a).

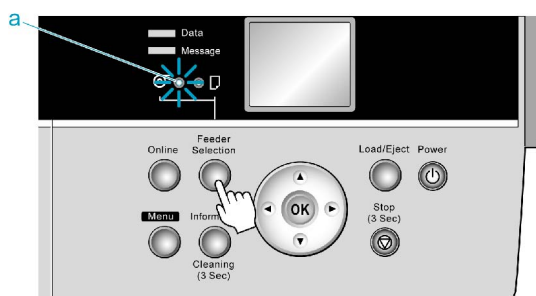

Caution

- Paper jams may occur if you load paper other than the paper specified in the paper settings for the media source.



Note

- You cannot switch the paper source in the following situations:
 - If the **Message lamp** is flashing
Check the message on the Display Screen and take action as necessary. (→P.687)
 - If the **Data lamp** is flashing
Select the paper source after printing.
 - If a printer menu operation is in progress
Select the paper source after the menu operation.
 - When in the process of loading paper
Finish loading the paper before selecting the paper source.
 - When in the process of replacing Ink Tanks
Finish replacing the Ink Tanks before selecting the paper source.
 - If the Top Cover is open
Close the Top Cover before selecting the paper source.

After you select the roll as the paper source, a message is displayed instructing you to load the roll. At this point, load the roll. (→P.119)



Note

- If any paper is loaded that will not be used, remove it before loading the roll.
(→P.122)
(→P.164)

>Loading Rolls on the Roll Paper Holder



Note

- For details on supported sizes and types of the roll that can be loaded, see Paper Sizes (→P.113) or the Paper Reference Guide. (→P.108)
- Align the edges of the paper on both ends of the roll.

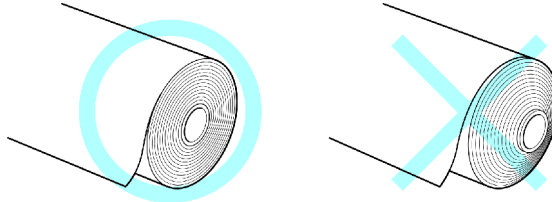

- If the edge of the roll is bent or soiled, use the **Paper Cutting** operation of the printer to cut the edge of the paper manually. (→P.129)
- If the paper is badly creased or bent, cut the edge of the roll with scissors before loading the roll in the printer, and then cut the edge of the paper manually using the **Paper Cutting** operation of the printer. (→P.129)
- To load a roll with a 3-inch paper core, insert the 3-Inch Paper Core Attachment on the roll holder and attach the 3-Inch Paper Core Holder Stopper. (→P.144)
- If you use a roll A2 or larger for **Borderless Printing**, insert the provided Spacer for Borderless Printing on the Roll Holder.

Follow the steps 3 and 4 below.

1. Remove the Holder Stopper from the Roll Holder.

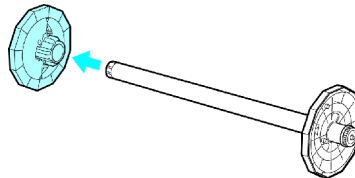

2. With the Roll Holder sideways and the edge of the roll paper facing forward as shown, insert the roll in the Roll Holder from the left. Insert the roll firmly until it touches the flange (a) of the Roll Holder.

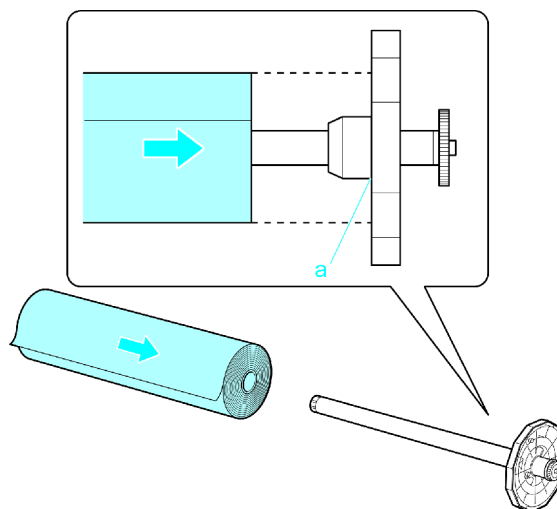

**Important**

- Always put the Roll Holder sideways when loading rolls. If you accidentally load a roll when the Roll Holder is upright, it may damage the Roll Holder.
- Set the roll on a table or other flat surface so that it does not roll or fall. Rolls are heavy, and dropping a roll may cause injury.

- 3.** Insert the Holder Stopper from the left in the Roll Holder as shown, pushing it firmly in until the flange (a) of the Holder Stopper touches the roll.

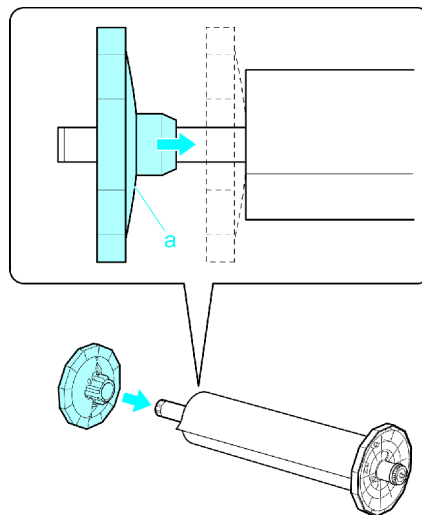
**Important**

- Insert the roll firmly until it touches the Holder Stopper. If it does not touch the stopper, feeding problems may occur.

Removing Rolls From the Roll Holder

1. Remove the Holder Stopper from the Roll Holder.

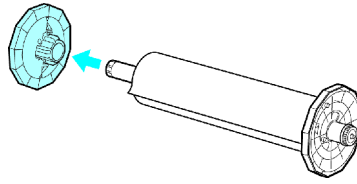

2. Remove the roll from the Roll Holder.

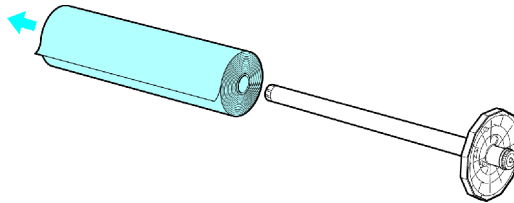

Important

- After removal, store the roll in the original bag or box, away from high temperature, humidity, and direct sunlight. If paper is not stored properly, the printing surface may become scratched, which may affect the printing quality when you use it again.



Note

- How to remove the 3-Inch Paper Core Attachment : (→P.144)
- How to remove the Spacer for Borderless Printing : (→P.144)

Loading Rolls in the Roll Feed Unit

1. Open the Roll Paper Unit Cover.

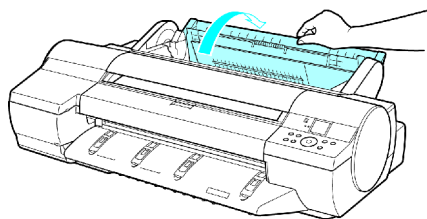

2. With the edge of the roll paper facing up toward you, insert the Roll Holder shaft into the guide grooves (a) of the Roll Holder Slot on both sides. Make sure that the colors of the Roll Holder shaft ends (b) and the guide grooves match.

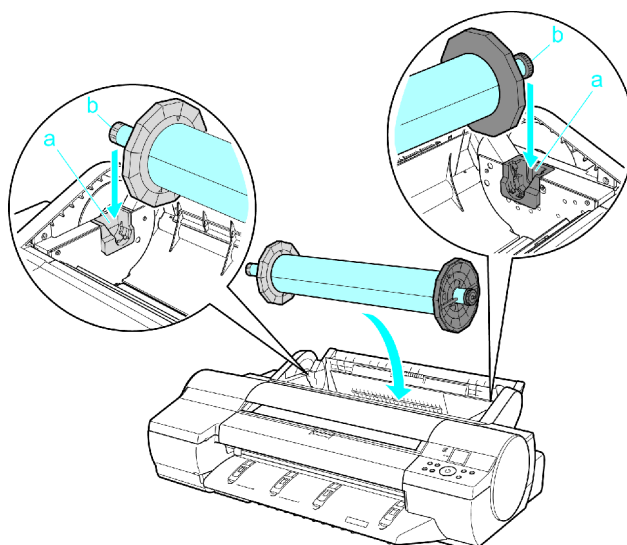

Caution

- Be careful not to pinch your fingers between the guide grooves (a) and the Roll Holder shaft (b) when loading rolls.



Note

- If it is difficult to load rolls from the front, load them from behind the printer.

Handling rolls

3. Insert the edge of the roll paper into the Paper Feed Slot (a) and feed it manually until you hear the paper feed tone.

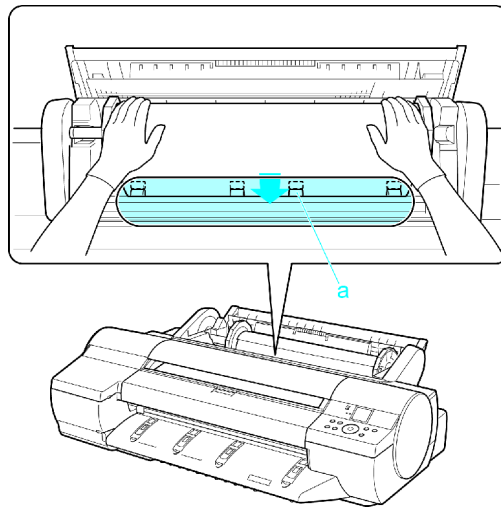

Important

- Be careful not to soil the printing surface of roll paper as you pull it out. This may affect the printing quality. We recommend wearing clean cloth gloves when handling rolls to protect the printing surface.
- If the paper is wrinkled or warped, straighten it out before loading it.
- Load paper straight so it is not fed askew.

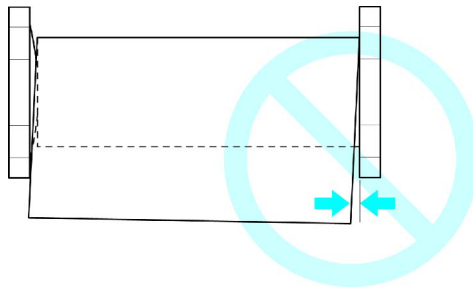

The printer now starts advancing the paper.

4. Specify the type and length of the paper.

How the printer operates after the paper is fed varies depending on the setting for automatic detection of the remaining roll paper, as well as the barcode printed on rolls.

Automatic Detection of the Remaining Roll Paper	Barcodes	Printer Operation After the Paper is Fed
On	Printed	The type and amount of paper left is automatically detected based on the barcode printed on the roll. There is no need to specify the type and length of the paper.
	Not printed	You must specify the type and length of the paper. A menu for selection of the paper type and length is automatically shown on the Display Screen . (→P.124) (→P.125)
Off	Printed	You must specify the type of paper. (→P.124)
	Not printed	

5. Close the Roll Paper Unit Cover.

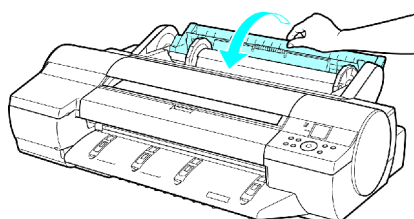

6. If the edge of the roll is bent or soiled, cut the edge of the paper.

1. Press the **Online** button to bring the printer offline.
2. Press **▲** or **▼** to feed the roll paper to the position for cutting.
3. Select **Yes** in **Paper Cutting** on Printer Menu, and then press the **OK** button. (→P.129)

Removing Rolls from the Roll Feed Unit



Caution

- If you have activated automatic detection of the remaining roll paper, always follow these steps to remove rolls. You will be unable to manage the amount of roll paper left if you remove the roll before the barcode is printed.



Important

- When a roll has been advanced, do not pull it out by force. This will prevent the paper from being advanced, and you will be unable to manage the amount of roll paper left. If you accidentally pull out the paper, hold down the **Stop** button to enable feeding.

1. Press the **Load/Eject** button.

A confirmation message is displayed regarding removal of the roll.

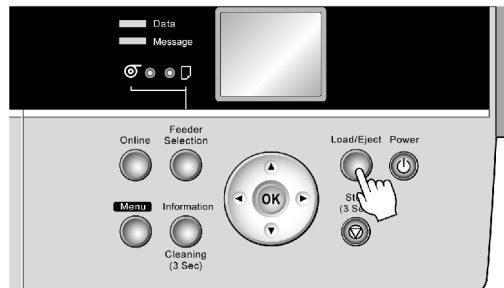

2. Press the **OK** button.

The roll can now be removed.



Note

- If you need to cut the roll, select **Paper Cutting** and cut the roll at the desired position. (→P.129)
- If you have selected **Media Menu > Chk Remain.Roll > On** in the printer menu and the printed document has been ejected, a barcode and brief text message are printed on the leading edge of rolls.

If the document is not cut but kept in the printer, only the text message is printed. This is also the case when printing on 8-inch rolls or clear film.

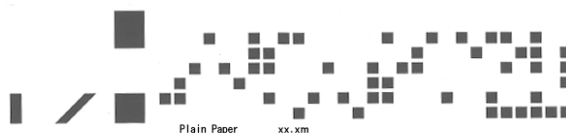

3. Open the Roll Paper Unit Cover.

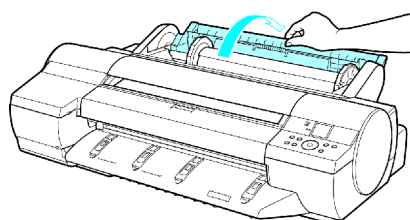

- 4.** Using both hands, rotate the Roll Holder toward the back to rewind the roll.

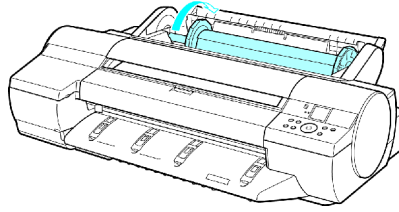

- 5.** Remove the Roll Holder from the Roll Holder Slot.

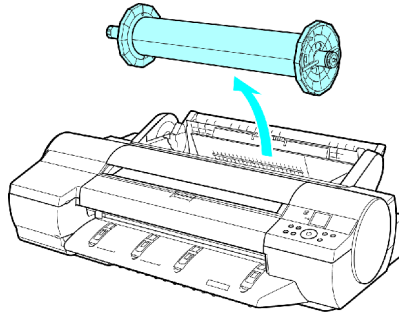

- 6.** Close the Roll Paper Unit Cover.

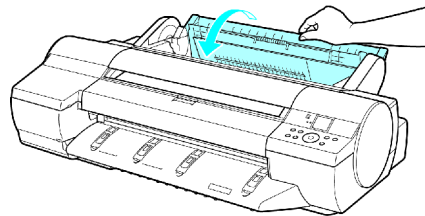

☐ Selecting the Paper Type (Roll)

When changing the type of paper after the paper has been advanced, specify the type of paper as follows.



Important

- For best printing results, the printer fine-tunes the feed amount for each type of paper. That's why the margins and the size of printed images may vary depending on the type of paper used. If printing results are not as you expected, adjust the paper feed amount and Printhead height.
(→P.589)
(→P.588)



Note

- After you load the roll, the printer automatically shows a menu for selection of the paper type on the Display Screen, unless a barcode has been printed on the roll or you have activated automatic detection of the remaining roll paper. Select the type of paper, and then press the **OK** button. If no barcode has been printed on the roll and you have activated automatic detection of the remaining roll paper, specify the roll length after the paper type. (→P.125)

1. Press the **Menu** button to display **MAIN MENU**.

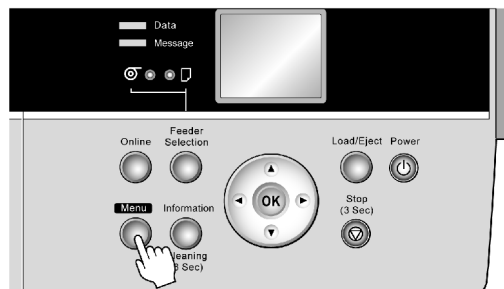

2. Press **▲** or **▼** to select **Media Menu**, and then press the **▶** button.
3. Press **▲** or **▼** to select **Roll Media Type**, and then press the **▶** button.
4. Press **▲** or **▼** to select the type of paper loaded in the printer, and then press the **OK** button.



Note

- For details on types of paper, see the Paper Reference Guide. (→P.108) By factory default, Plain Paper is selected.
- Be sure to select the correct paper type. If this setting does not match the loaded paper, it may cause feed errors and affect the printing quality.

5. Press the **Online** button to bring the printer online.

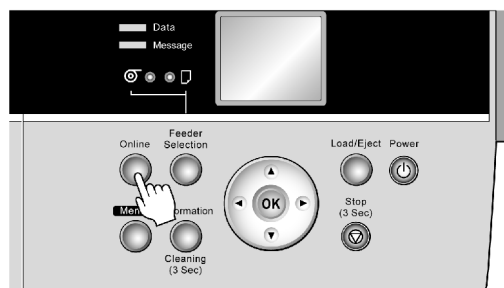

Specifying the Paper Length (Roll)

When changing the length of paper after the paper has been advanced, specify the length as follows.



Note

- When you specify the roll length in the printer menu, **Chk Remain.Roll** must be set to **On**. If it is **Off**, the **Roll Length Set** menu is not shown.
- After you load a roll and specify the roll type, the printer automatically shows a menu for selection of the roll length on the Display Screen if no barcode has been printed on the roll and you have activated automatic detection of the remaining roll paper. Select the roll length, and then press the **OK** button. The printer will automatically go online.

1. Press the **Menu** button to display **MAIN MENU**.

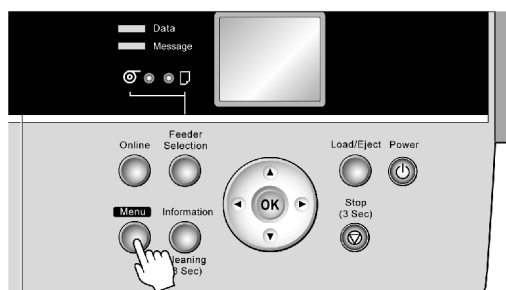

2. Press **▲** or **▼** to select **Media Menu**, and then press the **▶** button.

3. Press **▲** or **▼** to select **Roll Length Set**, and then press the **▶** button.

4. Press **▲** or **▼** to select the length of paper loaded in the printer, and then press the **OK** button.

Specify the roll length as follows.

1. Press **◀** or **▶** to move the cursor () to each field for entering numbers.
2. Press the **▲** or **▼** button to enter the value.
3. Repeat steps 1 and 2 to finish entering the value, and then press the **OK** button.

5. Press the **Online** button to bring the printer online.

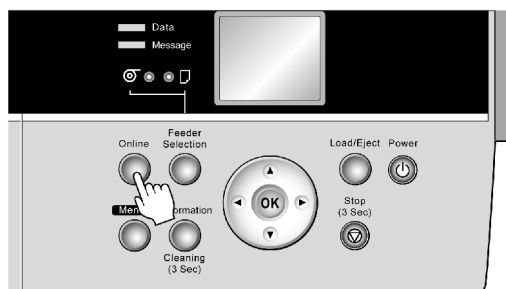

Feeding Roll Paper Manually

You can bring the printer offline by pressing the **Online** button.

When the printer is offline and roll paper is selected as the paper source, you can advance or retract the roll by pressing ▲ or ▼.

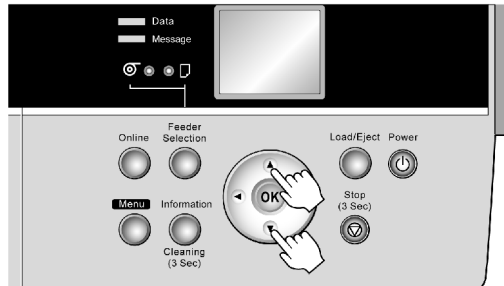

Press ▲ to retract the roll manually.

Press ▼ to advance the roll manually.

If you hold down the ▲ or ▼ button for less than a second, the roll paper will move about 1 mm (0.039 in).

If you hold down ▲ or ▼ for more than a second, the paper will move until you release the button. Release the button when the Display Screen indicates **End of paper feed. Cannot feed paper more.**

☐ Detection of the Remaining Roll Paper

If you have activated automatic detection of the remaining roll paper, when the roll is ejected, a barcode with text is printed on the roll paper that identifies the type of paper and amount left. If this function is activated and barcodes are printed on the roll paper, the type of paper and amount left are automatically detected when you load a roll. The barcode will be cut off after it has been read.

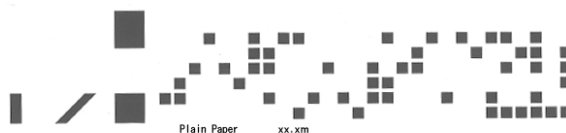

Note

- If the document is not cut but kept in the printer, only the text message is printed. This is also the case when printing on 8-inch rolls or clear film.



Important

- If the barcode on the roll is not detected, enter the type and length of paper on the Control Panel.

Follow these steps to activate detection of the remaining roll paper.

1. Press the **Menu** button to display **MAIN MENU**.

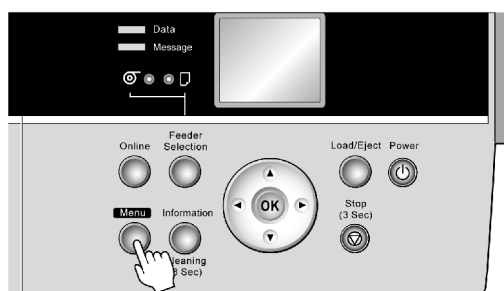

2. Press ▲ or ▼ to select **Media Menu**, and then press the ► button.
3. Press ▲ or ▼ to select **Chk Remain.Roll**, and then press the ► button.
4. Press ▲ or ▼ to select the desired setting option, and then press the **OK** button.

☐ Cutting the Leading Edge of Roll Paper Automatically

If the leading edge of a roll is crooked or warped, it may cause an error message or printing problems. In this case, set **Trim Edge First** to **Automatic** or **On** on the Control Panel to have the printer cut the leading edge to make the edge straight after you load a roll.

Trim Edge First offers the following options.

- **Automatic**

If the left and right side of the leading edge of the roll ((a) and (b)) are uneven by 3 mm (0.12 in) or more when you load the roll, the edge is cut an amount relative to the slant to ensure a straight edge, and scraps are removed. The edge is not cut if the unevenness is less than 3 mm.

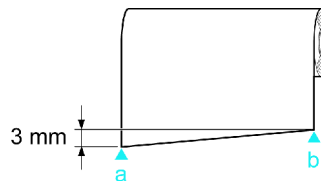

- **Off**

The edge is not cut and scraps are not removed. This setting is **Off** for most types of paper, by default. For more information, see the Paper Reference Guide. (→P.108)

- **On**

The leading edge is cut off when you load a roll, and scraps are removed. The amount of paper cut off from the leading edge varies depending on the paper type. For more information, see the Paper Reference Guide. (→P.108)

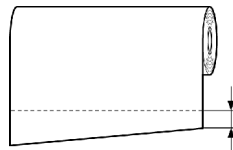

Note

- If you print on paper that has an irregular width, set **Skew Check Lv.** to **Loose** for a higher skew detection threshold or to **Off** to disable skew detection. However, if paper is loaded askew when detection is **Off**, note that paper jams or Platen soiling may occur.

Follow these steps to change the **Trim Edge First** setting.

1. Press the **Menu** button to display **MAIN MENU**.

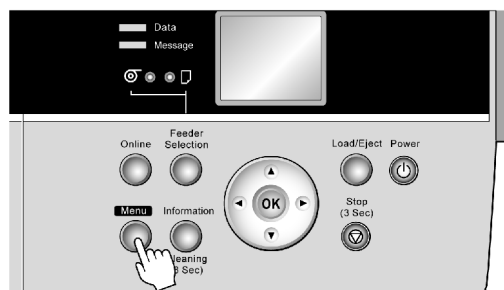

2. Press **▲** or **▼** to select **Paper Details**, and then press the **▶** button.
3. Press **▲** or **▼** to select the type of paper, and then press the **▶** button.
4. Press **▲** or **▼** to select **Trim Edge First**, and then press the **▶** button.
5. Press **▲** or **▼** to select the desired setting option, and then press the **OK** button.

This setting takes effect the next time you load a roll.

Specifying the Cutting Method for Rolls

How a roll is cut after ejection varies depending on the printer settings.

Cutting Method		Menu Settings		Driver Setting	
Automatic	The roll is automatically cut by the Cutter Unit following printer driver settings.	Cutting Mode	Automatic	Auto Cut	Yes
Eject (→P.130)	Choose this setting if you prefer not to have documents dropped immediately after printing, as when waiting for ink to dry. To cut the roll using the Cutter Unit, hold down the Stop button for a second or more.		Eject		Yes
Manual (→P.131)	Choose this setting when using media that cannot be cut using the Cutter Unit. Cut each page from the roll using scissors. For continuous printing (if you will cut each page later), in Auto Cut , select Yes , or select Print Cut Guideline . (→P.421)		Manual		No Yes Print Cut Guideline
Paper Cutting (→P.133)	Choose this option if you want to cut pages by pressing Cutter Unit buttons for manual cutting after printing when the printer driver is configured to Auto Cut > No or Print Cut Guideline . Otherwise choose this option if you want to cut the roll edge after loading a roll.	Paper Cutting	Yes		No Print Cut Guideline



Note

- Automatic and Eject are valid only when you have specified **Auto Cut > Yes** in the printer driver.
- With Eject, printing does not resume after a series of jobs have been printed continuously until the roll is cut.

Cut rolls manually in the following cases:

Eject (waiting for ink to dry after printing)

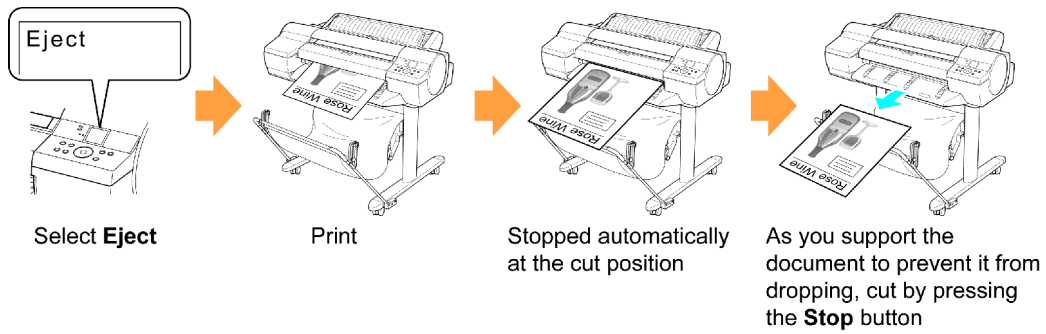

Important

- When cutting wide printed documents after ejection, support the documents. If the paper drops, printed documents may be damaged.
- Do not lift the paper when holding printed documents before cutting. If the paper rises, it may affect the printing quality.

1. Press the **Menu** button to display **MAIN MENU**.

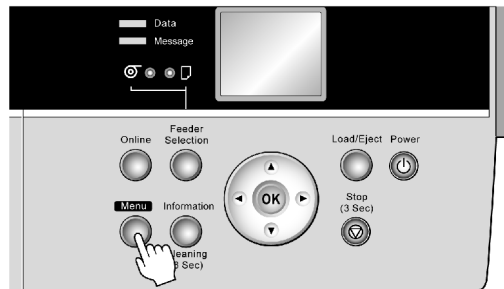

2. Press **▲** or **▼** to select **Paper Details**, and then press the **▶** button.

3. Press **▲** or **▼** to select the type of paper, and then press the **▶** button.

4. Press **▲** or **▼** to select **Cutting Mode**, and then press the **▶** button.

5. Press **▲** or **▼** to select **Eject**, and then press the **OK** button.

6. Start printing.

Roll paper is fed to the specified cut position and then automatically stopped.

7. As you support the printed document to prevent it from dropping, hold down the **Stop** button for at least a second to cut the roll.

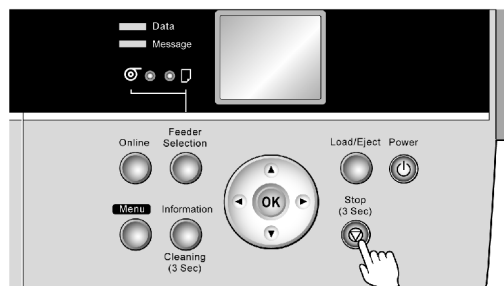

Manual (when using media that cannot be cut using the Cutter Unit)

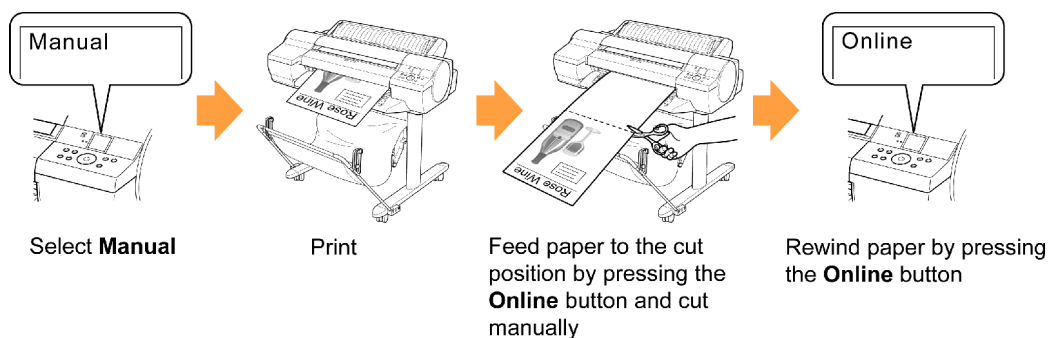

1. Press the **Menu** button to display **MAIN MENU**.

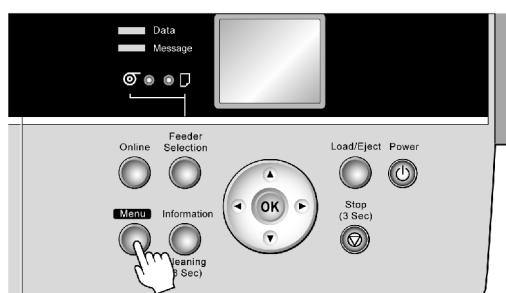

2. Press **▲** or **▼** to select **Paper Details**, and then press the **▶** button.
3. Press **▲** or **▼** to select the type of paper, and then press the **▶** button.
4. Press **▲** or **▼** to select **Cutting Mode**, and then press the **▶** button.
5. Press **▲** or **▼** to select **Manual**, and then press the **OK** button.
6. Start printing.
The printer stops advancing the paper after printing.
7. Press the **Online** button.

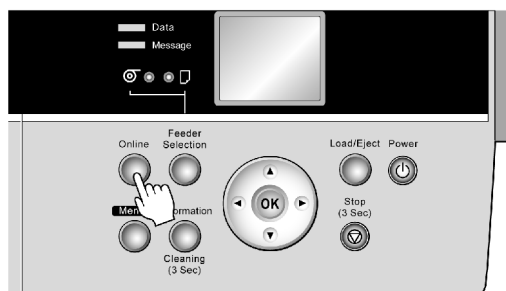

Roll paper is fed to the specified cut position and then automatically stopped.

8. Use scissors to cut the roll paper along the cut line.

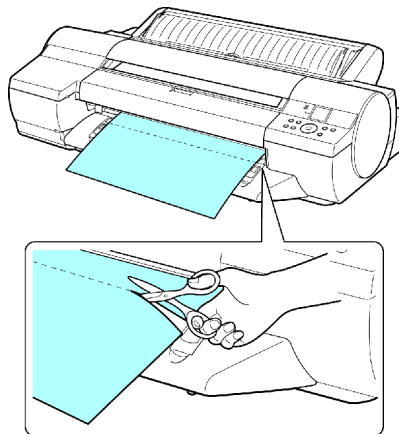

9. Press the **Online** button.

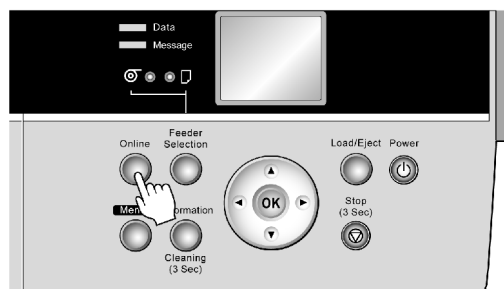

The roll is rewound, and rewinding stops automatically.

Paper Cutting (to have the roll cut at your specified position)

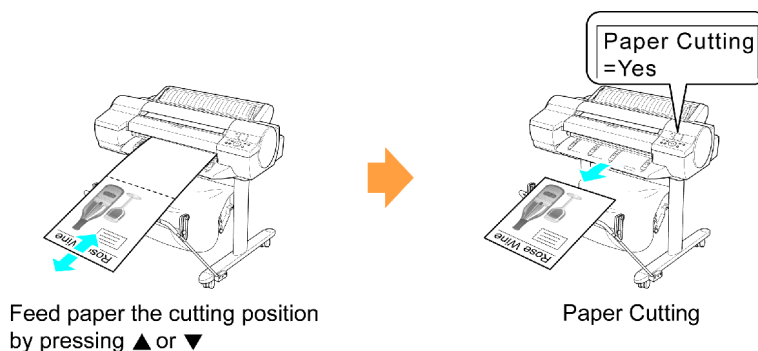

1. If the printer stops operating after printing, press the **Online** button. The printer goes offline.

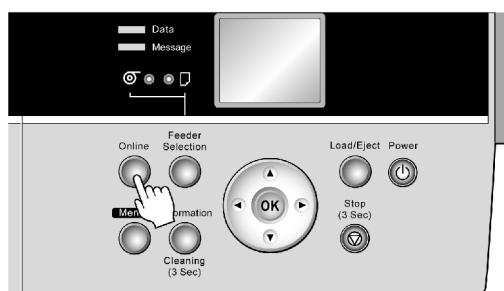

2. Press ▲ or ▼ to feed the roll paper to the position for cutting.

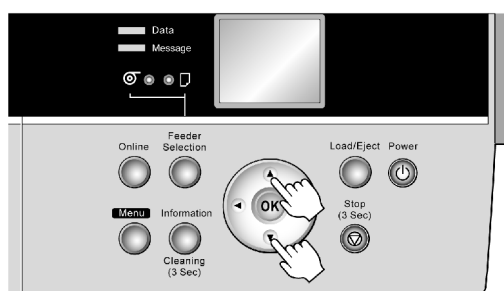

3. Press the **Menu** button to display **MAIN MENU**.

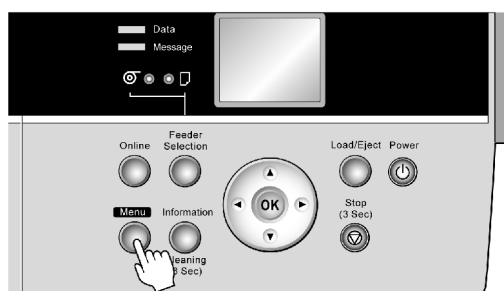

4. Press ▲ or ▼ to select **Paper Cutting**, and then press the ► button.

5. Press ▲ or ▼ to select **Yes**, and then press the **OK** button.

After the roll paper is cut, it is rewound automatically.



Caution

- If paper would be short when cut at a particular position, the roll may automatically be advanced in some cases before cutting.

Reducing Dust from Cutting Rolls

The printer is equipped with a function to reduce cutting dust for media such as Backlit Film that are more likely to generate debris when cut. This may improve printing quality and help prevent Printhead damage. You can set up this function to be activated for some types of paper.

When this function is activated, black lines are printed at the leading and trailing edges of documents.

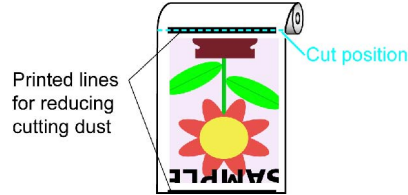

Important

- Do not activate the function to reduce cutting dust for paper that wrinkles easily, such as Plain Paper or lightweight paper. This may impair cutting and cause paper jams.
- Borderless printing is not available when this function is activated. Deactivate this function before borderless printing.

1. Press the **Menu** button to display **MAIN MENU**.

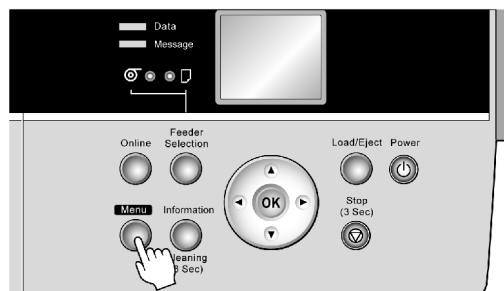

2. Press ▲ or ▼ to select **Paper Details**, and then press the ► button.
3. Press ▲ or ▼ to select the type of paper loaded in the printer, and then press the ► button.
4. Press ▲ or ▼ to select **CutDustReduct.**, and then press the ► button.
5. Press ▲ or ▼ to select **On**, and then press the **OK** button.

The function to reduce cutting dust is now activated.

Specifying the Ink Drying Time for Rolls

When you are using paper that takes longer for ink to adhere, if the Cutter touches printed surfaces that are still wet, it may damage the paper or cause rough cut edges. Also, ink may be transferred onto the paper surface during ejection, soiling it. You can prevent problems by adjusting the drying time after printing before the paper is cut.

Windows

1. Display the printer driver dialog box.
(→P.149)
2. Select the **Main** sheet and click **C Advanced Settings** in **A Media Type**.

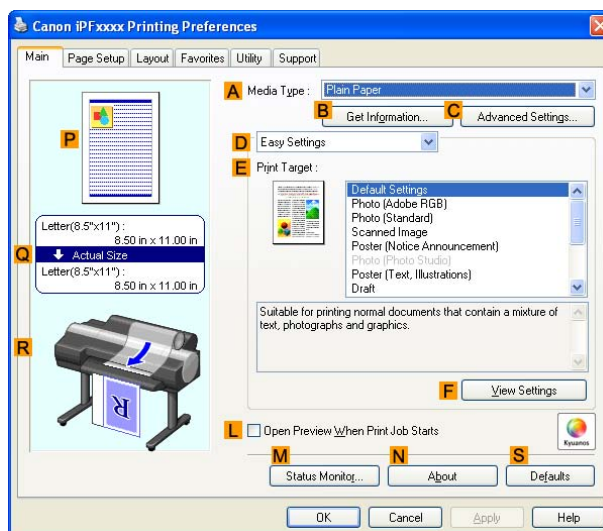

3. In the **Media Detailed Settings** dialog box displayed next, select **C Between Pages** and **D Between Scans** in **B Drying Time**, and then click **OK**.
(→P.151)

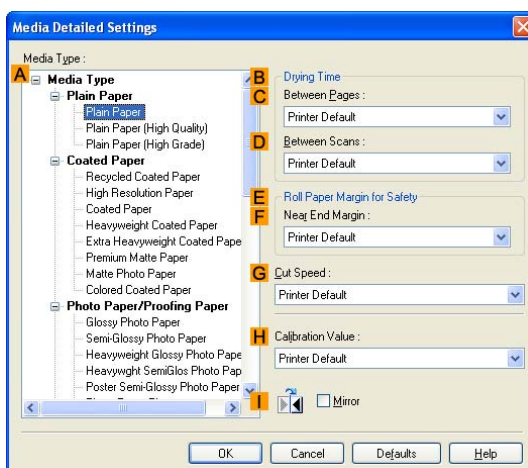

Mac OS X

1. Choose **Print** in the application menu.
2. Select the **Main** pane and click **C Settings** in **A Media Type**.

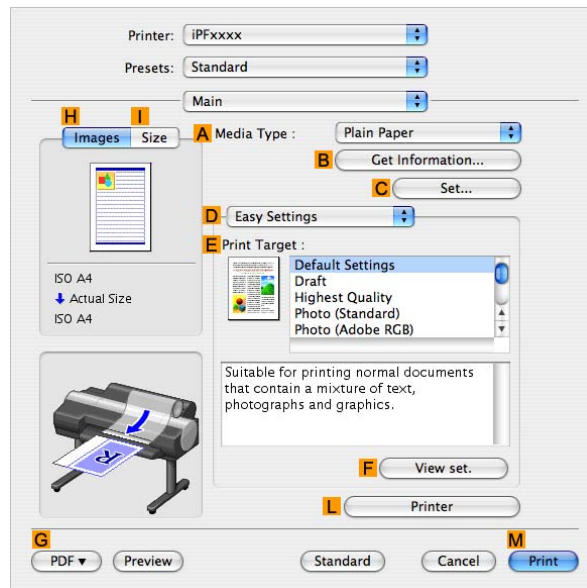

3. In the **Media Detailed Settings** dialog box displayed next, select **C Between Pages** and **D Between Scans** in **B Drying Time**, and then click **OK**.

(→P.152)

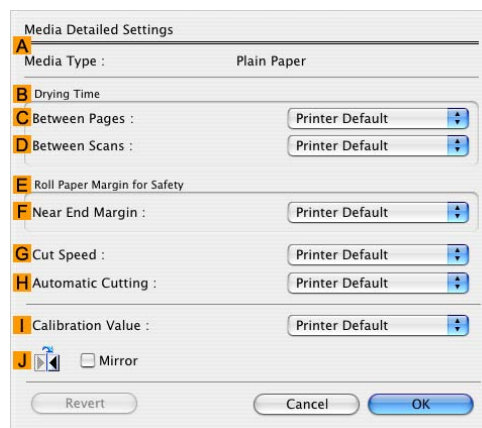

Mac OS 9

1. Choose **Print** in the application menu.
2. Select the **Main** pane and click **D Settings** in **A Media Type**.

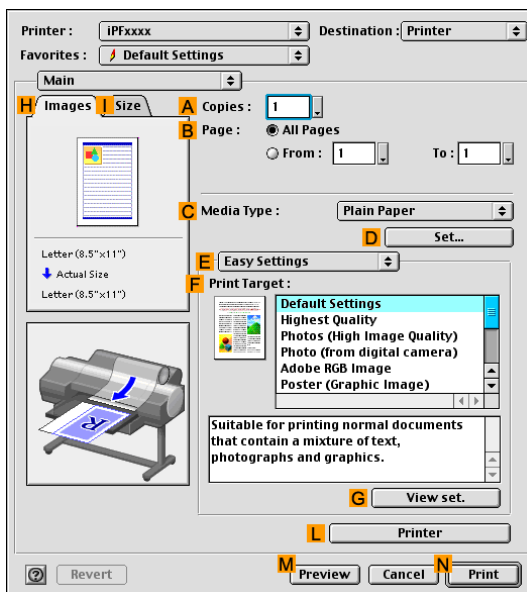

3. In the **Media Detailed Settings** dialog box displayed next, select **C Between Pages** and **D Between Scans** in **B Drying Time**, and then click **OK**.

(→P.153)

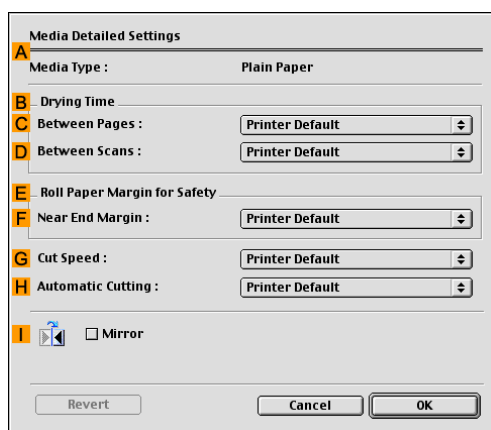

Note

- By factory default, **Drying Time** is deactivated (**Off**) for all paper types.
- To have the printer wait for ink to dry immediately after printing without releasing paper, set **Cutting Mode** to **Eject** in the printer menu.

(→P.129)

Clearing Jammed Roll Paper

If paper from a roll becomes jammed, **Paper jam.** is shown on the Display Screen of the Control Panel. Remove the jammed paper as follows.



Note

- For instructions on removing a paper jam from a roll if the scrap of paper remains in the Paper Feed Slot, see “Clearing Jammed Paper (Paper Feed Slot)”. (→P.142)

1. Open the Roll Paper Unit Cover. Use a store-bought cutter or the like to cut the paper of the loaded roll.

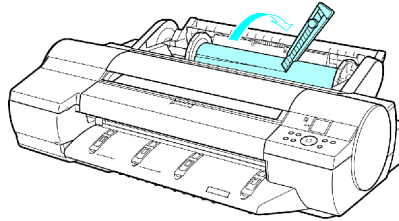

Caution

- When cutting paper, be careful to avoid scratching the printer.

2. Press **Load/Eject** button.

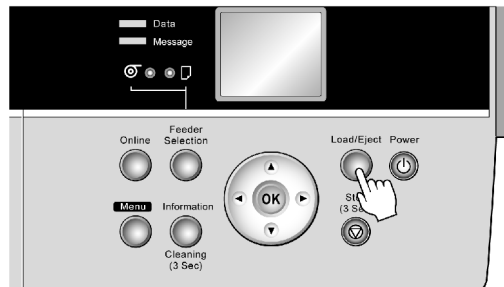

3. Remove the jammed paper.

- If paper is jammed inside the Top Cover

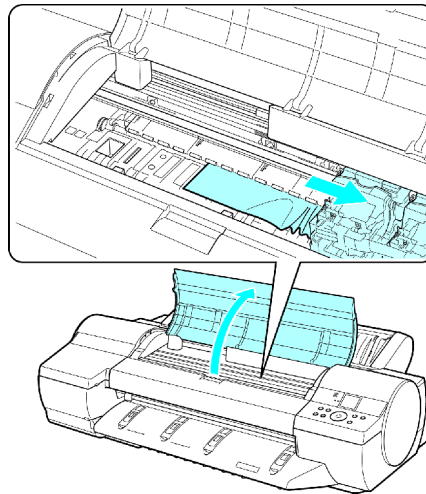
1. Open the Top Cover and move the Carriage to the side.**2. Clear any jammed paper from inside the Top Cover.**

After removing the paper, make sure there are no other scraps of paper in the printer.

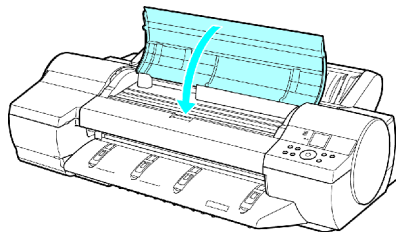
3. Close the Top Cover.**Important**

- Do not touch the Linear Scale (a) or Carriage Shaft (b).

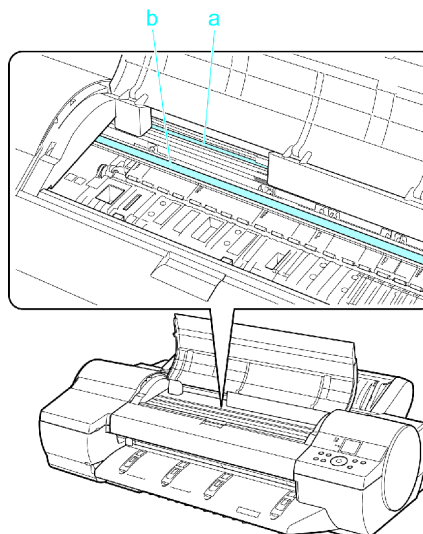

Handling rolls

- If paper from a roll is jammed by the Paper Feed Slot

1. Open the Roll Paper Unit Cover.

2. Remove the jammed paper from the Paper Feed Slot.

After removing the paper, make sure there are no other scraps of paper in the printer. If paper is jammed deep in the Paper Feed Slot (→P.141), remove the Roll Feed Unit and clear the paper jam.

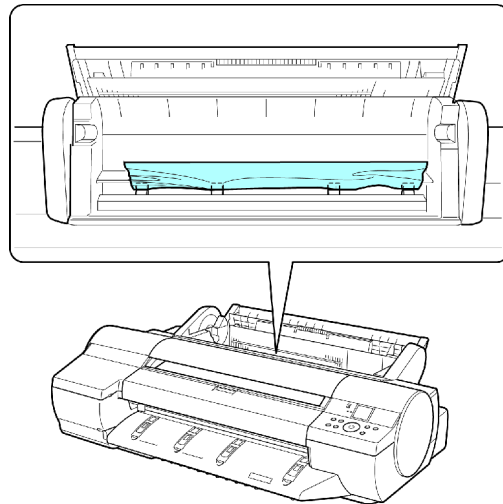

- If the paper is jammed by the Ejection Guide

Remove the jammed paper from the Output Tray.

After removing the paper, make sure there are no other scraps of paper in the printer.

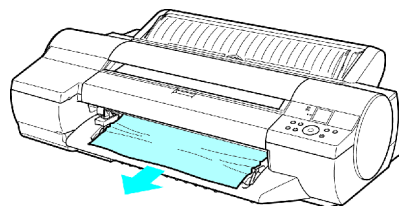

4. Press **OK**.

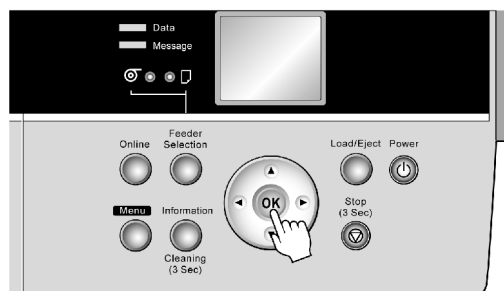

If paper is jammed deep in the Paper Feed Slot, remove the Roll Feed Unit and clear the paper jam as follows.

- 1.** Turn off the printer and remove the Roll Feed Unit from the printer. (→P.147)
- 2.** Remove the jammed paper from the Paper Feed Slot.

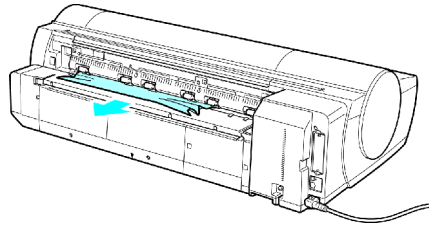

After removing the paper, make sure there are no other scraps of paper in the printer.

- 3.** Install the Roll Feed Unit on the printer again. (→P.148)

☐ Clearing Jammed Paper (Paper Feed Slot)

Follow these steps to remove any scraps left in the Paper Feed Slot after you clear jammed sheets or roll paper.

1. Press the **Feeder Selection** button to activate the **Cut Sheet lamp**.
2. Press the **Load/Eject** button.
A screen is displayed for paper type selection.
3. Select POP Board and press the **OK** button.
A screen is displayed for paper size selection.
4. Select the desired size and press the **OK** button.
Instructions for feeding POP Board are shown on the Control Panel, but instead of following them, follow this procedure to remove the jammed paper.
5. Open the Top Cover.
6. Fold an A4 sheet lengthwise four times and insert it through the gap of the Back Cover. Push the scrap out toward the Platen.

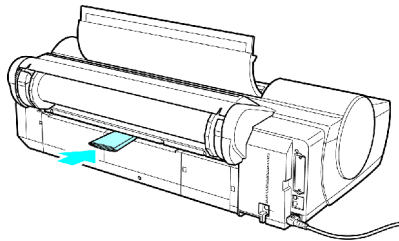

7. Remove the scrap when it is pushed out onto the Platen.
8. If any scraps remain inside the Paper Feed Slot, repeat steps 6 and 7.
9. Close the Top Cover.
10. Turn the printer off. (→P.19)

Roll Holder Set

A set of parts including a Roll Holder, Holder Stopper (for 2- and 3-inch paper cores), 3-Inch Paper Core Attachment, and Spacer for Borderless Printing (used for both 2- and 3-inch paper cores).

To load a roll with a 3-inch paper core, insert the 3-Inch Paper Core Attachment on the Roll Holder and attach the Holder Stopper for 3-inch paper cores. If you use an A1 (594 mm [23.4 in]) roll or A2 (420 mm [16.5 in]) roll for borderless printing, insert the Spacer for Borderless Printing on the Roll Holder.

- Roll Holder Set RH2-24
 - Roll Holder

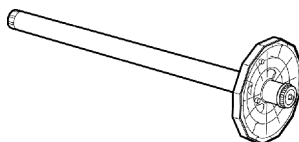

- Holder Stopper (for 2- and 3-inch paper cores (a) and (b))

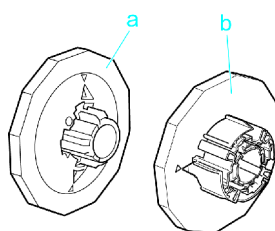

- 3-Inch Paper Core Attachment

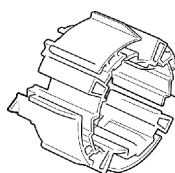

- Spacer for Borderless Printing



For instructions on installing these parts, see “Attaching Accessories to the Roll Holder”. (→P.144)

Attaching Accessories to the Roll Holder

Mounting the 3-Inch Paper Core Attachment

To load a roll with a 3-inch paper core, insert the 3-Inch Paper Core Attachment on the Roll Holder. Align the triangular part (b) of the 3-Inch Paper Core Attachment (a) with the triangular groove (c) of the Roll Holder as shown, and insert the 3-Inch Paper Core Attachment into the Roll Holder.

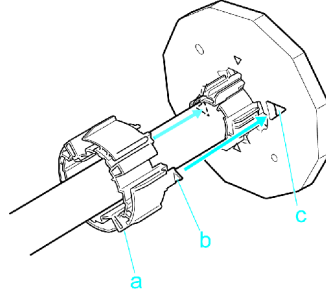

Removing the 3-Inch Paper Core Attachment

Spread the tips (b) of the 3-Inch Paper Core Attachment that protrude by the triangular label (a) of the Roll Holder as shown, and remove the 3-Inch Paper Core Attachment.

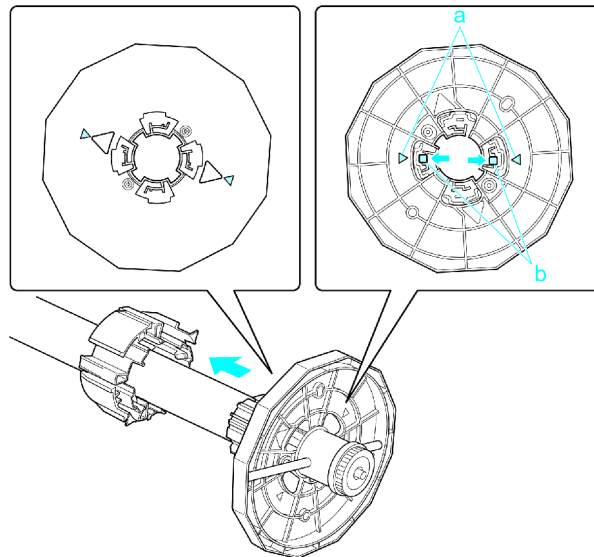

Attaching the Spacer for Borderless Printing

If you use an A1 or A2 roll for borderless printing, insert the provided Spacer for Borderless Printing on the Roll Holder.

Insert the protrusions (b) of the Spacer for Borderless Printing (a) into the holes (c) of the Roll Holder, as shown.

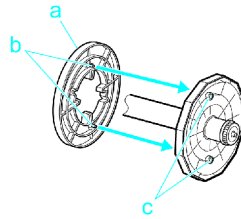

Important

- If you use an A1 or A2 roll for borderless printing, be sure to attach the provided Spacer for Borderless Printing on the Roll Holder. If you do not attach the Spacer for Borderless Printing on the Roll Holder, an error message will be displayed and printing is not possible.

Removing the Spacer for Borderless Printing

Pull out the Spacer for Borderless Printing from the Roll Holder, as shown.

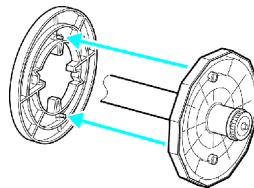

Feeding Paper from the Roll Feed Unit

The Paper Feed Slot used to feed roll paper is the same as the Paper Feed Slot used for the Top Paper Feed Slot, so both methods of feeding paper cannot be used at the same time.

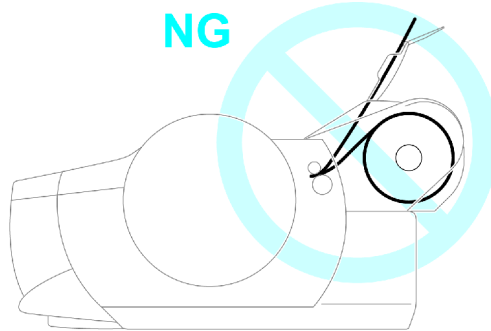

Thus, if a roll has been advanced when you wish to print from the Top Paper Feed Slot or Front Paper Feed Slot, change the paper source.

1. Select sheets as the paper source. (→P.154)
2. After **Remove roll?** is displayed, press the **OK** button.
The roll is rewound automatically.

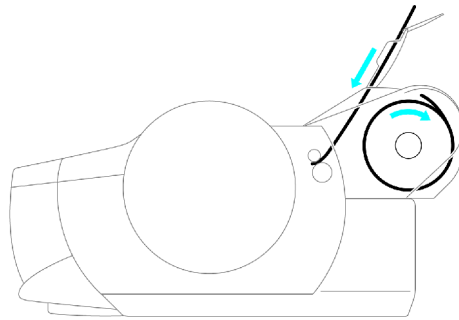

Similarly, if a sheet is in the Top Paper Feed Slot or Front Paper Feed Slot when you wish to print on a roll, you will need to remove the sheet from the slot and reinsert the roll paper (which has been rewound) in the Paper Feed Slot.

1. Select the roll as the paper source. (→P.115)
2. After **Eject sheet?** is displayed, press the **OK** button.
The sheet is ejected automatically.

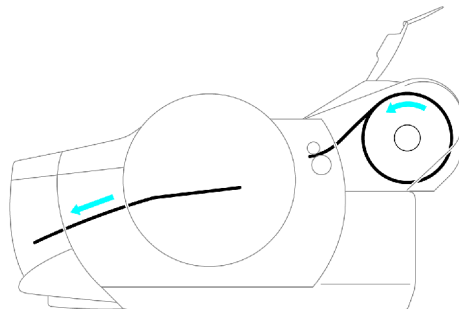

Removing the Roll Feed Unit



Important

- Always make sure the printer is off before removing the Roll Feed Unit.

1. Remove any rolls in the Roll Feed Unit. (→P.122)
2. Use a coin or screwdriver to loosen the screws (a) on both sides of the back of the Roll Feed Unit and remove the unit from the printer.

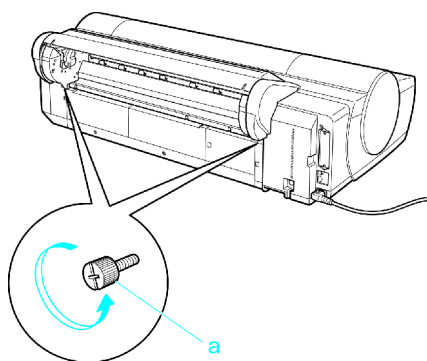

3. Hold the Roll Feed Unit by the Carrying handles (a) as you remove the Roll Feed Unit from the printer.

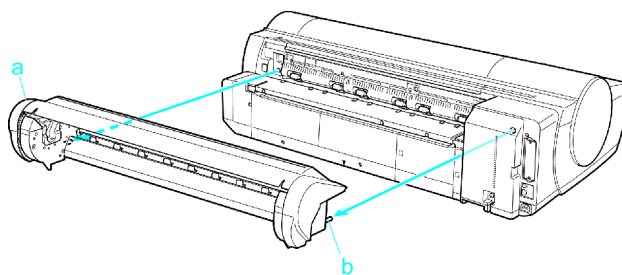

Installing the Roll Feed Unit



Important

- Always make sure the printer is off before attaching the Roll Feed Unit.

1. Holding the Roll Feed Unit by the Carrying handles (a), insert the two pins of the Roll Feed Unit (b) into the each hole on the back of the printer (c).

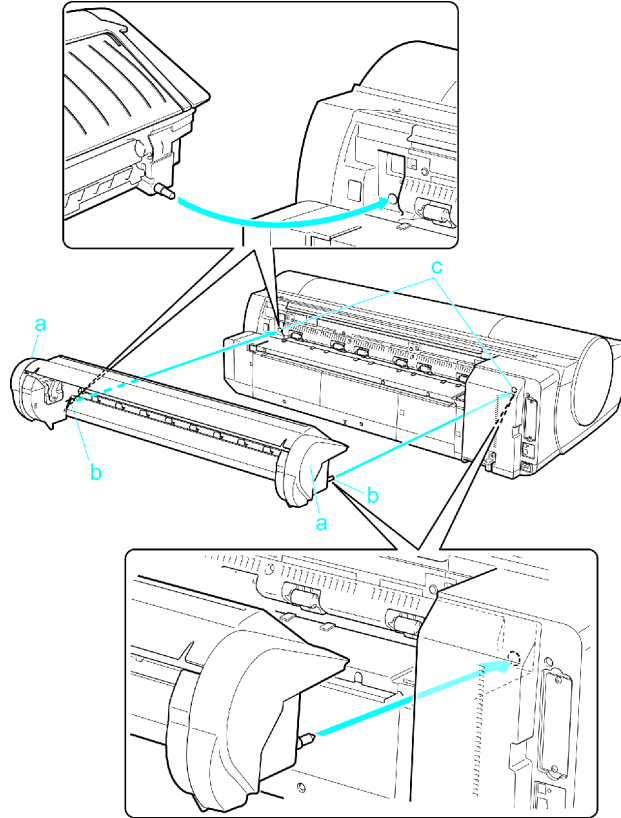

2. Use a coin or screwdriver to tighten the two screws on the back of the Roll Feed Unit (a) to secure it to the printer.

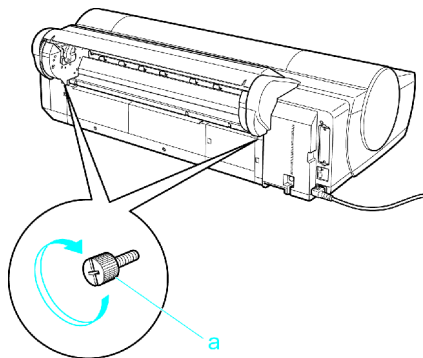

Accessing the Printer Driver Dialog Box from the Operating System Menu (Windows)

1. Click **start > Printers and Faxes** (or **Printers**).
2. Select the printer, and then display the printer properties dialog box.

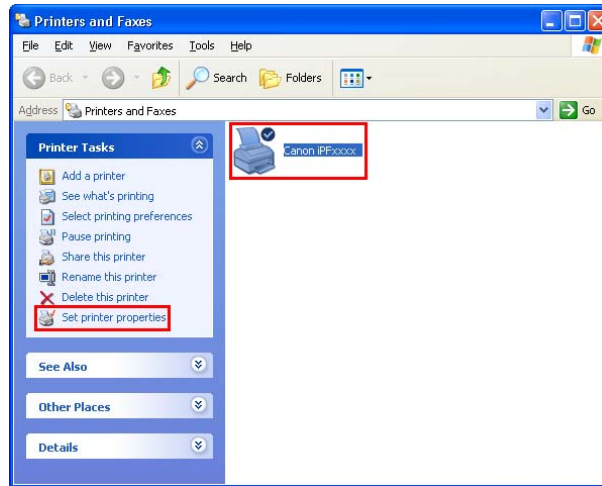

3. Click **Printing Preferences** to display the **Printing Preferences** dialog box, titled with the name of this printer.

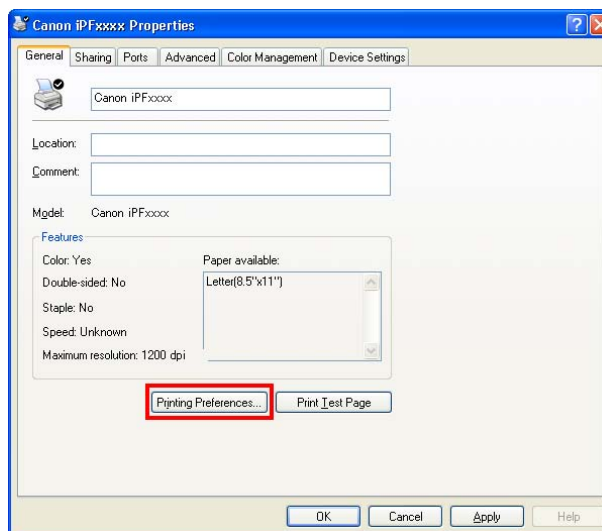

Note

- The **Device Settings** sheet is also an extension of the printer driver. (→P.462)

Six sheets of print settings are displayed by the printer driver: **Main**, **Page Setup**, **Layout**, **Favorites**, **Utility**, and **Support**.

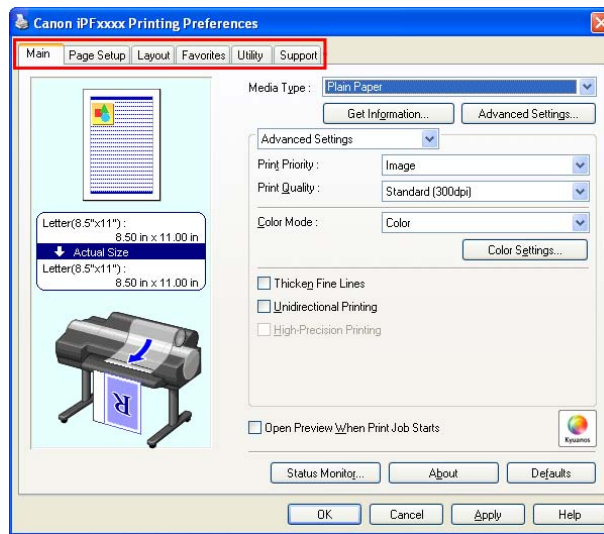

Important

- If you access the printer driver dialog box from the operating system menu, changes you make to the settings will apply to all applications you use for printing.
- You can also access the printer driver dialog box from applications. see “Accessing the Printer Driver Dialog Box from Applications (Windows)”. (→P.473)

Media Detailed Settings Dialog Box (Windows)

The **Media Detailed Settings** dialog box offers the following settings. For details on settings items, refer to the printer driver help.

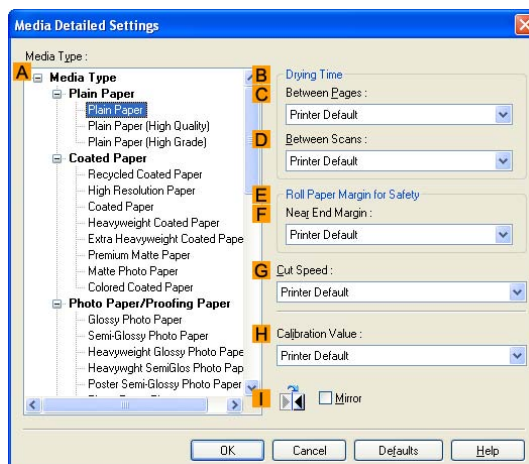

Note

- To display the **Media Detailed Settings** dialog box, on the **Main Sheet (Windows)** (→P.450), click **Settings by Media Type**.

Setting Item	Description
A Media Type	Select the paper type. For information on the types of paper the printer supports, refer to the Paper Reference Guide . (→P.108)
B Drying Time	Specify the time that the printer waits for ink to dry, as needed. The Drying Time setting is only valid for rolls. (→P.135)
C Between Pages	Specify the time the printer waits after printing a page until ejecting the paper, as needed.
D Between Scans	Specify the time the printer waits after printing a line on the page until printing the next line, as needed.
E Roll Paper Margin for Safety	You can specify the length of a margin on the leading edge of paper to ensure that paper susceptible to curling is held firmly against the Platen .
F Near End Margin	Specify the length of the Near End Margin (the leading edge margin) of the roll, as needed.
G Cut Speed	Select the speed of automatic cutting, as needed. You can adjust this setting if paper is not cut well when automatic cutting is used.
H Calibration Value	You can specify whether to apply the results of calibration performed on the printer to image processing.
I Mirror	Specify whether to print a mirror image, as needed. Select this option to print a version of the document or image with the left and right sides inverted.

Media Detailed Settings Dialog Box (Mac OS X)

The **Media Detailed Settings** dialog box offers the following settings. For details on settings items, refer to the printer driver help.

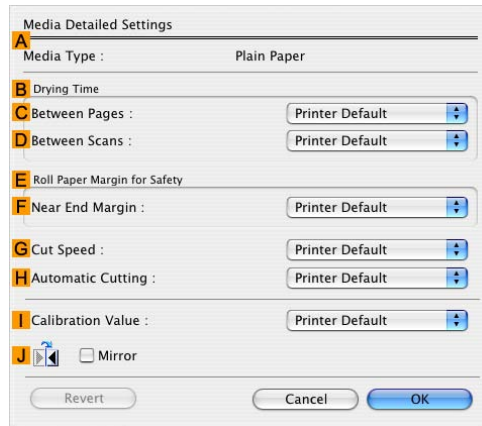

Note

- To display the **Media Detailed Settings** dialog box, on the **Main Pane** (Mac OS X) (→P.499) , click **Settings by Media Type**.

Setting Item	Description
A Media Type	Select the paper type. For information on the types of paper the printer supports, refer to the Paper Reference Guide . (→P.108)
B Drying Time	Specify the time that the printer waits for ink to dry, as needed. The Drying Time setting is only valid for rolls. (→P.135)
C Between Pages	Specify the time the printer waits after printing a page until ejecting the paper, as needed.
D Between Scans	Specify the time the printer waits after printing a line on the page until printing the next line, as needed.
E Roll Paper Margin for Safety	You can specify the length of a margin on the leading edge of paper to ensure that paper susceptible to curling is held firmly against the Platen .
F Near End Margin	Specify the length of the Near End Margin (the leading edge margin) of the roll, as needed.
G Cut Speed	Select the speed of automatic cutting, as needed. You can adjust this setting if paper is not cut well when automatic cutting is used.
H Automatic Cutting	You can activate or deactivate Automatic Cutting and printing of cut lines, as desired. In this list, specify Yes , No , or Print Cut Guideline .
I Calibration Value	You can specify whether to apply the results of calibration performed on the printer to image processing.
J Mirror	Specify whether to print a mirror image, as needed. Select this option to print a version of the document or image with the left and right sides inverted.

Media Detailed Settings Dialog Box (Mac OS 9)

The **Media Detailed Settings** dialog box offers the following settings. For details on settings items, refer to the printer driver help.

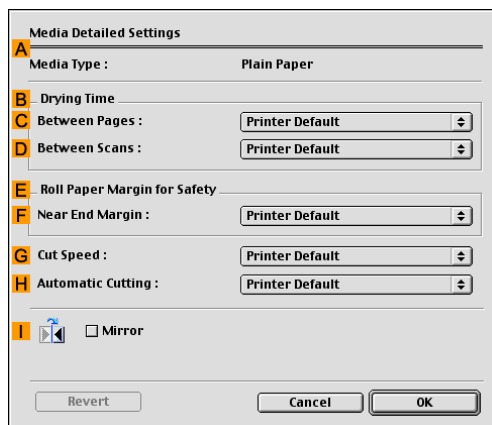

Note

- To display the **Media Detailed Settings** dialog box, on the **Main Pane** (Mac OS 9) (→P.521), click **Settings by Media Type**.

Setting Item	Description
A Media Type	Select the paper type. For information on the types of paper the printer supports, refer to the Paper Reference Guide . (→P.108)
B Drying Time	Specify the time that the printer waits for ink to dry, as needed. The Drying Time setting is only valid for rolls. (→P.135)
C Between Pages	Specify the time the printer waits after printing a page until ejecting the paper, as needed.
D Between Scans	Specify the time the printer waits after printing a line on the page until printing the next line, as needed.
E Roll Paper Margin for Safety	You can specify the length of a margin on the leading edge of paper to ensure that paper susceptible to curling is held firmly against the Platen .
F Near End Margin	Specify the length of the Near End Margin (the leading edge margin) of the roll, as needed.
G Cut Speed	Select the speed of automatic cutting, as needed. Adjust this setting if paper is not cut well when automatic cutting is used.
H Automatic Cutting	You can activate or deactivate Automatic Cutting and printing of cut lines, as desired. In this list, you can specify Yes or No and Print Cut Guideline .
I Mirror	Specify whether to print a mirror image, as needed. Select this option to print a version of the document or image with the left and right sides inverted.

Handling sheets for paper feed slots

☐ Selecting the Sheet as the Paper Source

You can switch the paper source between the roll and the sheet by pressing the **Feeder Selection** button. Each time you press this button, the paper source switches between the roll (indicated by the **Roll Media lamp**) and the sheet (indicated by the **Cut Sheet lamp**).

Press the **Feeder Selection** button to activate the **Cut Sheet lamp** (a).

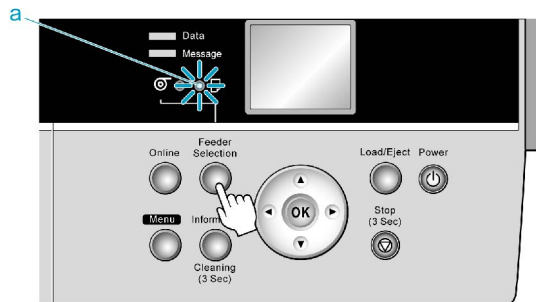

Caution

- Paper jams may occur if you load paper other than the paper specified in the paper settings for the media source. If you insert the edge of a roll in the Paper Feed Slot after you have selected sheets as the type of paper in the media source on the Control Panel and specified the type and size of paper, the printer will prepare to print on the roll. If you print under these conditions, an error will occur when the roll is ejected. (→P.699)



Note

- You cannot switch the paper source in the following situations:
 - If the **Message lamp** is flashing
Check the message on the Display Screen and take action as necessary. (→P.687)
 - If the **Data lamp** is flashing
Select the paper source after printing.
 - If a printer menu operation is in progress
Select the paper source after the menu operation.
 - When in the process of loading paper
Finish loading the paper before selecting the paper source.
 - When in the process of replacing Ink Tanks
Finish replacing the Ink Tanks before selecting the paper source.
 - If the Top Cover is open
Close the Top Cover before selecting the paper source.

Select sheets as the paper source, press the **Load/Eject** button, and load the sheet. If you want to change the type or size of paper shown on the Control Panel, press the **Menu** button and change the settings in the Control Panel menus.

(→P.162)

(→P.163)



Note

- Remove any loaded paper that will not be used. (→P.164)
- If a roll is loaded, the roll paper is automatically ejected.

☐ Loading Sheets Manually

When using the tray, load the paper in the Top Paper Feed Slot . (→P.156) However, if you have specified **POP Board**, insert the sheet in the Front Paper Feed Slot . (→P.158)

Loading paper in the Top Paper Feed Slot



Note

- You can load only one sheet in the Top Paper Feed Slot. Do not load more than one sheet at a time. This may cause paper jams.
 - Store unused paper in the original package, away from high temperature, humidity, and direct sunlight.
 - Paper that is wrinkled or warped may jam. If necessary, straighten the paper and reload it.
 - Load the paper straight. Loading paper askew will cause an error.
 - Before feeding paper or printing, make sure the sheet is flat against the Paper Tray Cover . The sheet may jam if it curls before feeding or printing and the trailing edge drops toward the front.
 - If a roll is loaded, rewind the roll before this procedure. (→P.146)
1. If you send a print job specifying a paper other than **POP Board** from a computer beforehand, the type and size of paper are shown on the Display Screen. Press the **Load/Eject** button.



Note

- If you will load paper before sending a print job, press the **Load/Eject** button. After a menu for selection of the type of paper is shown on the Display Screen, press ▲ or ▼ to select the type of paper, and then press the **OK** button. Next, a menu for selection of the paper size is shown on the Display Screen. Press ▲ or ▼ to select the size of paper, and then press the **OK** button.
2. Open the Paper Tray Cover (a), and then open the Tray Extension (b).

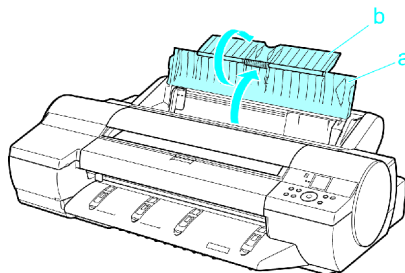

- Slide the Width Guide (a) to align it with the mark for the size of paper you will load.

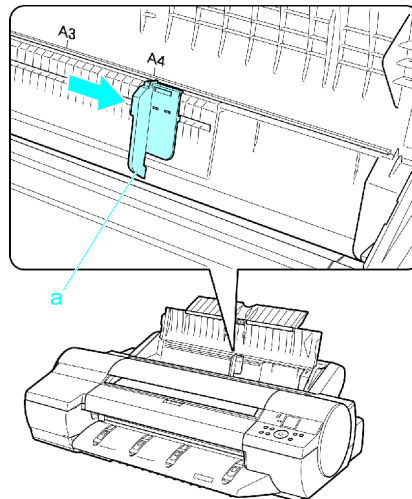

- Load the paper in the Top Paper Feed Slot with the printing side face-up. Insert the paper until its edge touches the far end of the tray lightly.

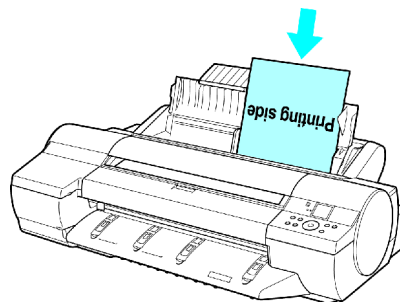

- Move the Width Guide (a) to match the size of paper loaded. Set the Width Guide against the edge of the paper to prevent the paper from becoming crooked or wrinkled.

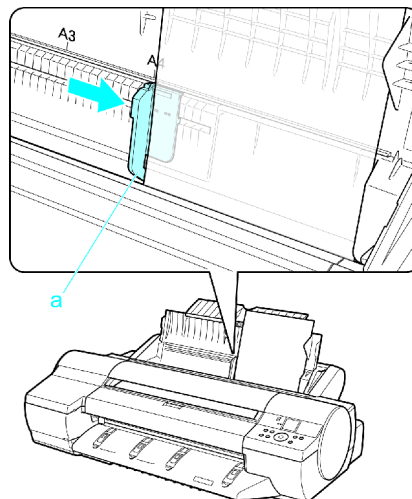

- Press the **OK** button to start feeding the paper. After the paper is advanced and the printer goes online, printing starts automatically. If no print job was received beforehand, the printer enters Standby mode.

Loading heavyweight paper in the Front Paper Feed Slot



Important

- Before loading heavyweight paper, change the media type setting to **POP Board**. After **POP Board** is selected as the type of paper, you can select Front Paper Feed Slot.
- Always load a **POP Board** in the Front Paper Feed Slot. Loading it another way may damage the printer or cause malfunction.



Note

- You can load only one sheet of paper at a time.
- Store unused paper in the original package, away from high temperature, humidity, and direct sunlight.
- If the paper is warped, straighten it before loading it.
- Load the paper straight. Loading paper askew will cause an error.
- After loading the paper, you cannot move it laterally to reposition it. Be sure to load the paper straight.

1. If you send a print job specifying **POP Board** from a computer beforehand, the type and size of paper are shown on the Display Screen. Press the **Load/Eject** button.



Note

- If you will load heavyweight paper before sending a print job, press the **Load/Eject** button. After a menu for selection of the type of paper is shown on the Display Screen, press **▲** or **▼** to select **POP Board**, and then press the **OK** button. Next, a menu for selection of the paper size is shown on the Display Screen. Press **▲** or **▼** to select the size of paper, and then press the **OK** button.

2. If **Leave 70cm (28") space behind printer.** is displayed, check the space behind the printer, lift the four Front Tray Guides on the Ejection Guide, and then press the **OK** button.

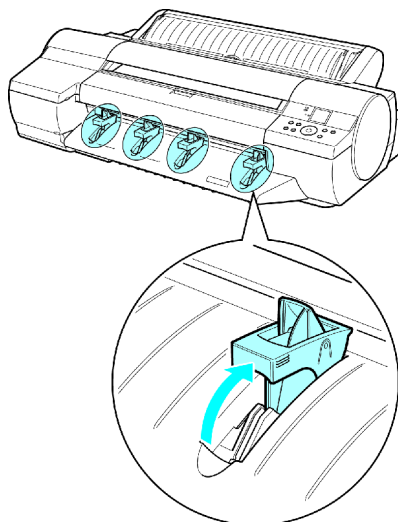

Note

- Sufficient space behind the printer is required when loading paper in the Front Paper Feed Slot. For details on the space required for installation, see "Specifications". (→P.72)

3. **Open Upper Cover** is displayed. At this point, open the Top Cover.

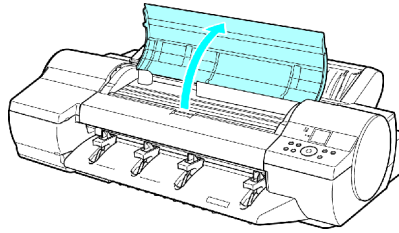

4. With the sheet printing-side up, place the leading edge on the Front Tray Guides and insert it straight into the Front Paper Feed Slot.

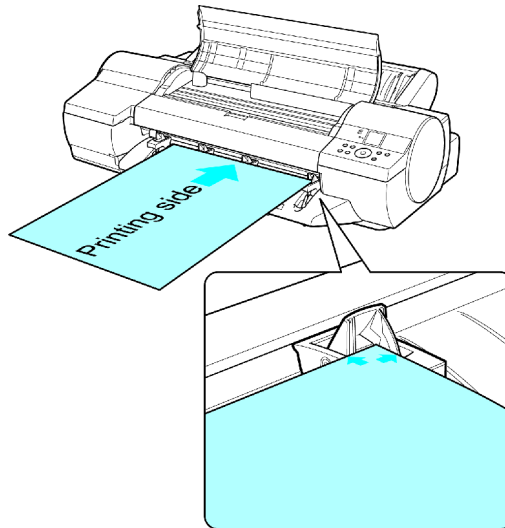

5. As you look inside the Top Cover, insert the leading edge of the paper between the Platen and Paper Retainer (a), keeping it parallel to the Paper Retainer (a), and align the paper with the Paper Alignment Line (b) of the Front Tray Guides.

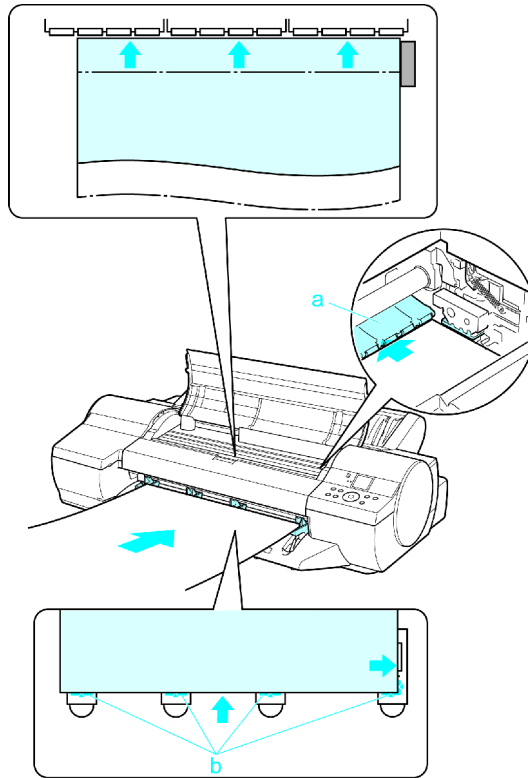

Important

- Never touch the Linear Scale (a) or Carriage Shaft (b). This may stain your hands and damage the printer.

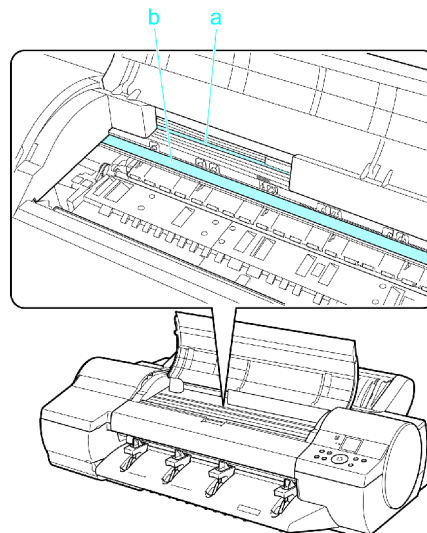

6. **Close top cover.** is displayed. At this point, close the Top Cover and press the **OK** button.

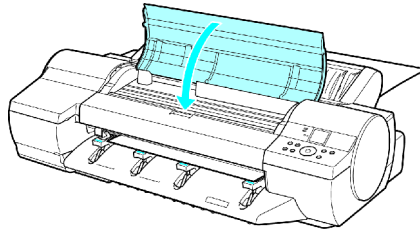

The paper is held between the Platen and Back Cover as it is fed.

After the paper is advanced and the printer goes online, printing starts automatically.

If no print job has been received from the computer beforehand, the printer enters Standby mode.

7. After printing, the printer will temporarily stop advancing the paper while the trailing edge is still in the rollers to prevent the sheet from dropping. Press the **Load/Eject** button to release the sheet. After pulling it straight out, press the **OK** button. (→P.165)
8. Lift the four Front Tray Guides on the Ejection Guide to store them toward the front, and then press the **OK** button.

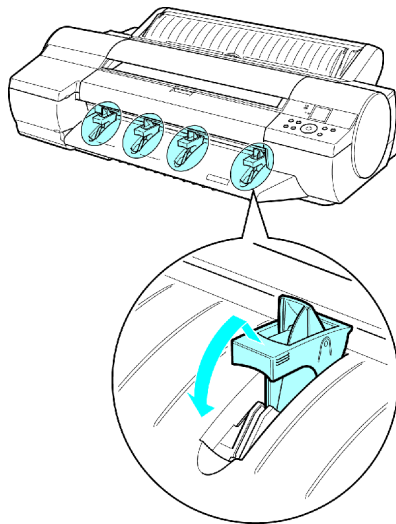

☐ Selecting the Paper Type (Sheet)

When changing the type of paper after the paper has been advanced, specify the type of paper as follows.



Note

- After you press the **Feeder Selection** button to illuminate the **Cut Sheet lamp**, press the **Load/Eject** button to display a screen for selection of the paper type. Press **▲** or **▼** to select the type of paper, and then press the **OK** button to display a screen for selection of the paper size. (→P.163)
- If you have sent the print job from a computer beforehand, the screen for paper type and size selection is not displayed. Printing will start after the paper is advanced.

1. Press the **Menu** button to display **MAIN MENU**.

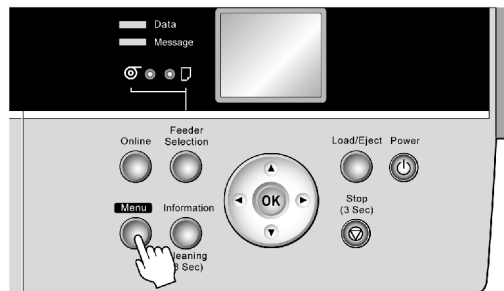

2. Press **▲** or **▼** to select **Media Menu**, and then press the **▶** button.
3. Press **▲** or **▼** to select **Manual PaperType**, and then press the **▶** button.
4. Press **▲** or **▼** to select the type of paper loaded in the printer, and then press the **OK** button.



Note

- Select **POP Board** when loading heavyweight paper.
- For details on paper types, see the Paper Reference Guide. (→P.108) Plain Paper is selected by factory default.
- Be sure to select the correct paper type. If this setting does not match the loaded paper, it may cause feed errors and affect the printing quality.

5. Press the **Online** button to bring the printer online.

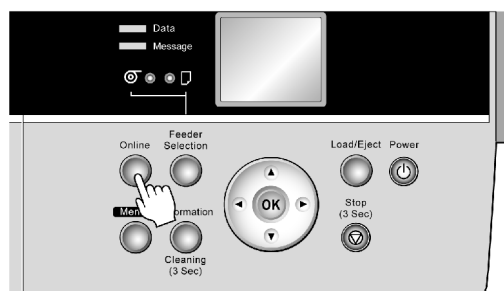

☐ Selecting the Paper Size (Sheet)

To change the paper size after paper has been advanced, select the paper size as follows.



Note

- After you press the **Feeder Selection** button to illuminate the **Cut Sheet lamp**, press the **Load/Eject** button to display a screen for selection of the paper type automatically. Press **▲** or **▼** to select the type of paper, and then press the **OK** button to display a screen for selection of the paper size. Press **▲** or **▼** to select the paper size, and then press the **OK** button. The printer is now ready to advance the paper.
- If you have sent the print job from a computer beforehand, the screen for paper type and size selection is not displayed. Printing will start after the paper is advanced.

1. Press the **Menu** button to display **MAIN MENU**.

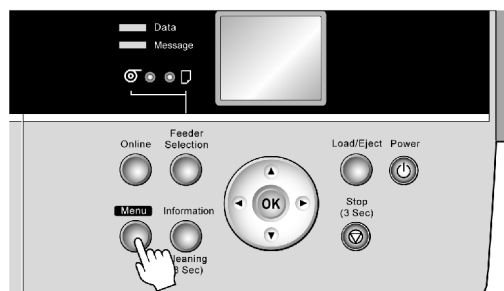

2. Press **▲** or **▼** to select **Media Menu**, and then press the **▶** button.
3. Press **▲** or **▼** to select **Manual PaperSize**, and then press the **▶** button.
4. Press **▲** or **▼** to select the size of paper loaded in the printer, and then press the **OK** button.



Note

- For details on paper sizes, see “Paper Sizes”. (→P.113)

5. Press the **Online** button to bring the printer online.

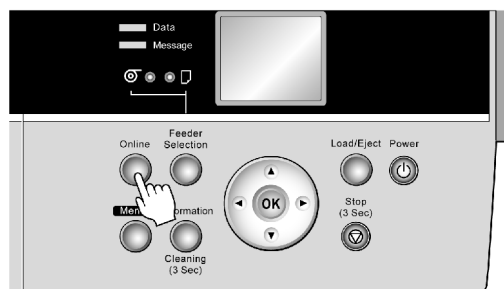

Removing Sheets from the Top Paper Feed Slot

Press the **Load/Eject** button to eject the sheet.

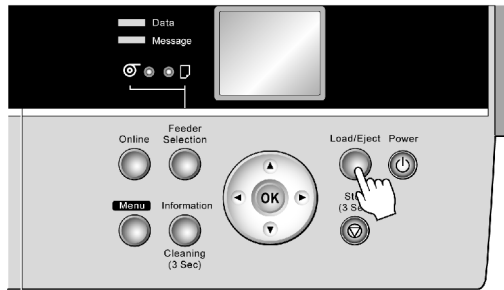

Note

- Paper cannot be ejected by using the **Load/Eject** button when print jobs are in progress or during the ink drying period. Before ejecting paper, press the **Stop** button to cancel printing, print job processing, or ink drying.

The paper is ejected from the front of the printer.

Removing Heavyweight Paper from the Front Paper Feed Slot

If you are printing heavyweight paper from the Front Paper Feed Slot, the printer will stop advancing the paper while the trailing edge is still in the rollers to prevent the sheet from dropping. In this case, remove the paper as follows.

1. Press the **Load/Eject** button.

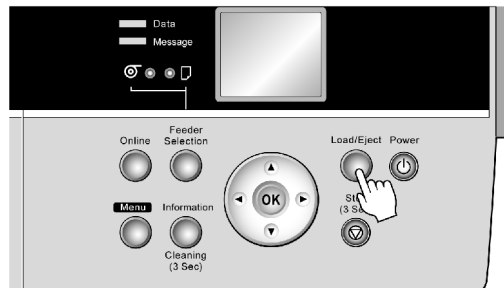

Note

- If you load paper from the Front Paper Feed Slot but press the **Load/Eject** button without printing, the printer will eject the paper and stop advancing it momentarily while the trailing edge is still in the rollers to prevent the sheet from dropping. Press the **Load/Eject** button again when you are ready to remove the paper.

2. Pull the sheet straight forward to remove it.



Note

- If you do not remove **POP Board** by pulling it straight forward, the printed surface may become scratched.

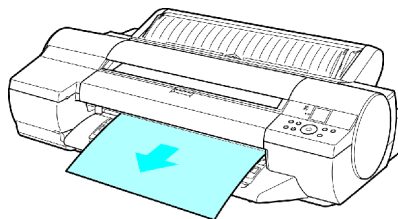

3. Press the **OK** button.

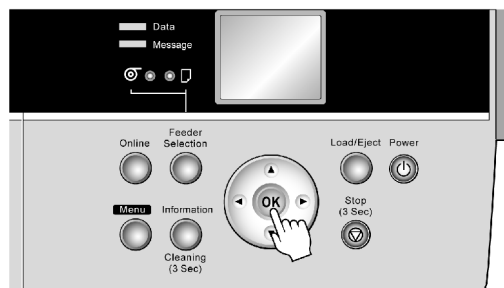

Caution

- After removal, press the **OK** button. If you do not remove the paper before doing subsequent operations, the sheet may go back inside the printer, leaving roller marks across the trailing edge of paper.

Clearing Jammed Paper from the Tray

If a sheet loaded manually becomes jammed, **Paper jam.** is shown on the Display Screen of the Control Panel. Remove the jammed paper as follows.

1. Press Load/Eject.

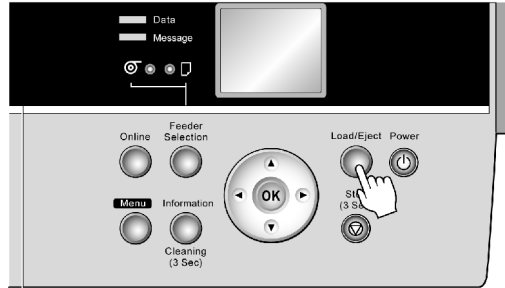

2. Remove the jammed paper.

- If paper is jammed inside the Top Cover

1. Open the Top Cover and move the Carriage to the side manually.

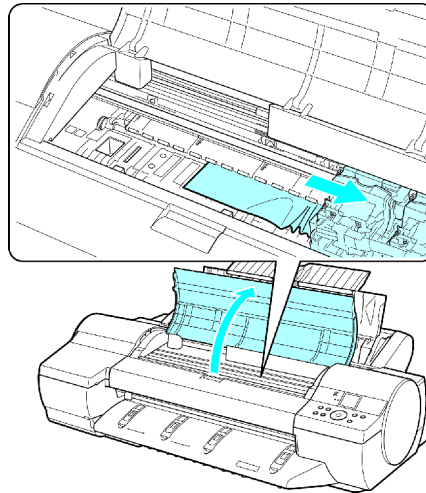

2. Clear any jammed paper from inside the Top Cover.

After removing the paper, make sure there are no other scraps of paper in the printer.

3. Close the Top Cover.

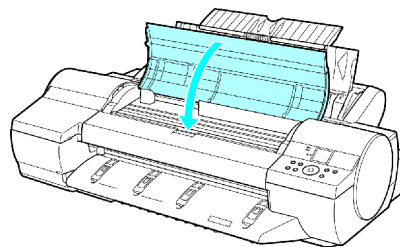



Important

- Do not touch the Linear Scale (a) or Carriage Shaft (b).

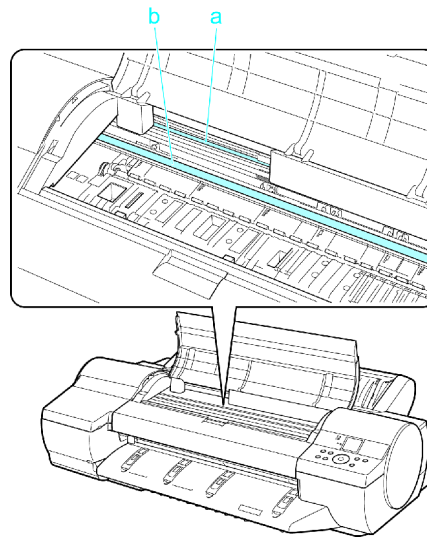

- If paper is jammed by the Paper Feed Slot of the Top Paper Feed Slot
Remove the jammed paper from the Paper Feed Slot.
After removing the paper, make sure there are no other scraps of paper in the printer. If paper is jammed deep in the Paper Feed Slot (→P.168), remove the Roll Feed Unit and clear the paper jam.

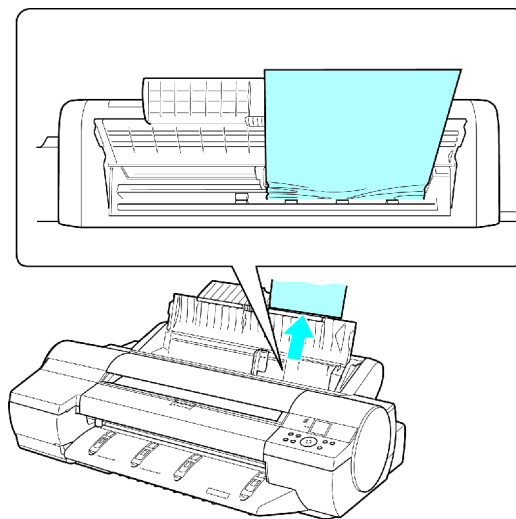

- If the paper is jammed by the Ejection Guide
Remove the jammed paper from the Output Tray.
After removing the paper, make sure there are no other scraps of paper in the printer.

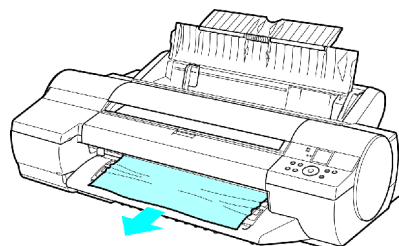

Handling sheets for paper feed slots

- If paper is jammed in the back of the printer
Remove the jammed paper from the back.
After removing the paper, make sure there are no other scraps of paper in the printer.

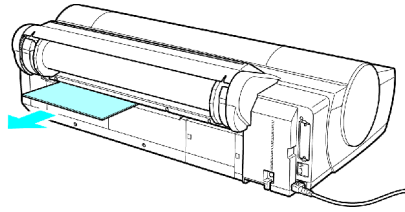

3. Press **OK** button.

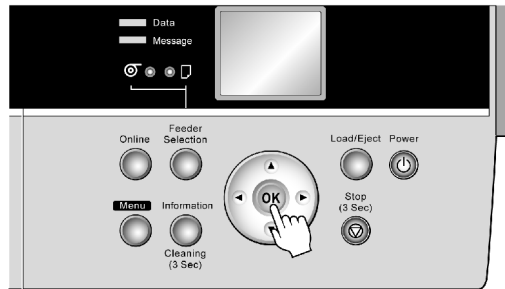

If paper is jammed deep in the Paper Feed Slot, remove the Roll Feed Unit and clear the paper jam as follows.

1. Turn off the printer and remove the Roll Feed Unit from the printer.
(→P.147)
2. Remove the jammed paper from the Paper Feed Slot.

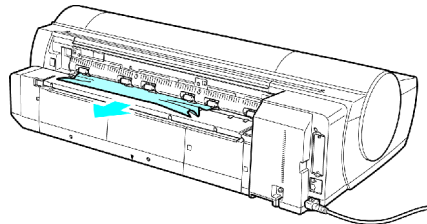

After removing the paper, make sure there are no other scraps of paper in the printer.

3. Install the Roll Feed Unit on the printer again.
(→P.148)

Output Stacker

Using the Output Stacker

The Output Stacker can be held at two positions, as shown.

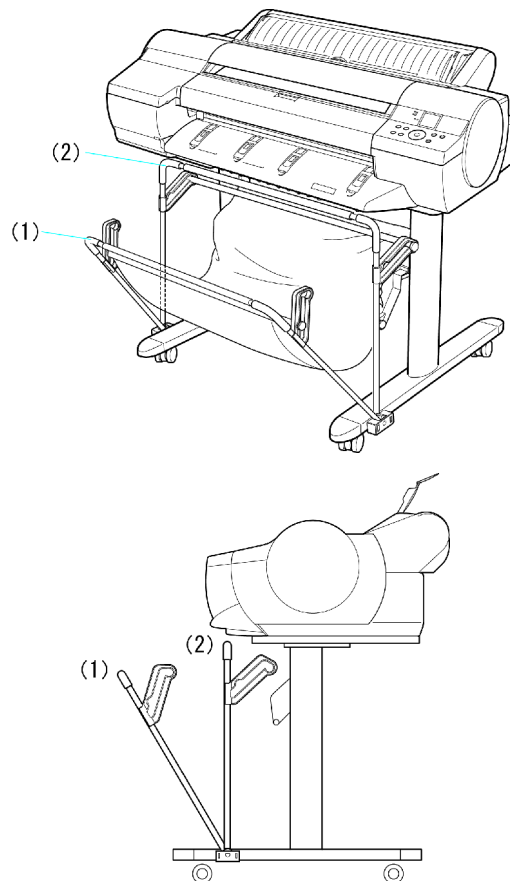

- When storing printed documents on the Output Stacker
Use position (1).
- When the Output Stacker is not used
Use position (2).



Important

- When storing printed documents on the Output Stacker, always use it in position (1). If you do not, printed documents may not be dropped into the Output Stacker, and the printed surface may become soiled.
- The Output Stacker can hold one sheet. When printing multiple pages, remove each sheet after it is printed.

Output Stacker

Use the Output Stacker in the normal position (a).

However, for some types of media, you can use the stacker in the position for easy removal (b). To switch the stacker to the position for easy removal, move the **Support Rod** to the position of (b). This position enables printed documents to be removed more easily.

For information on the position for easy removal, refer to the Paper Reference Guide. (→P.108)

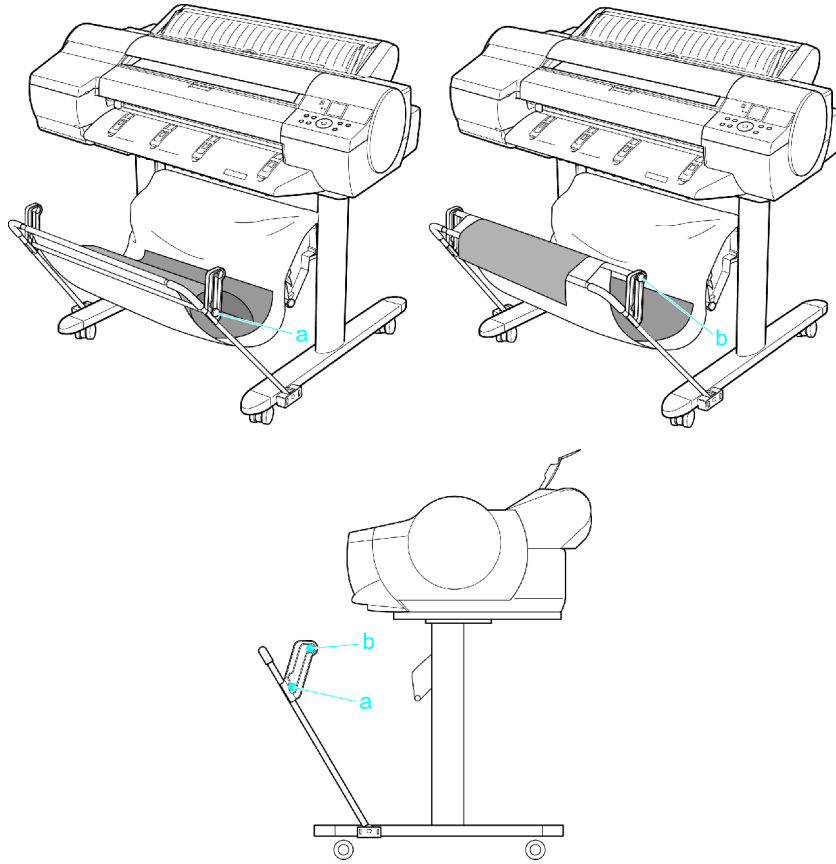

Output Stacker Precautions

When you print on rolls, you can use the Output Stacker to hold ejected printouts.

When you use the Output Stacker (b), push down Basket Rod #1 fully toward the front, keeping it even on the left and right so that Basket Rod #2 (a) is not slanted.

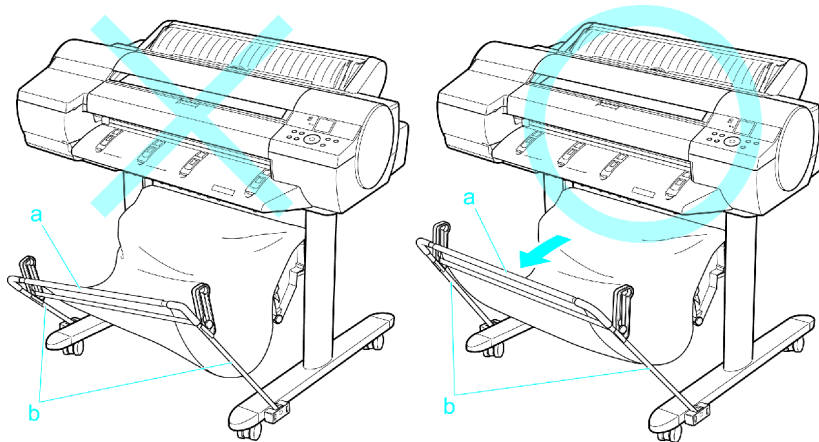

The Output Stacker can accommodate one sheet. Remove each sheet before printing if you are printing a series of documents.

Use the Output Stacker in the normal position (a). However, for some types of media, you can use the stacker in the extended position (b). This position enables printed documents to be removed more easily.

For information on types of paper you can use with the stacker in the extended position, refer to the Paper Reference Guide. (→P.108)

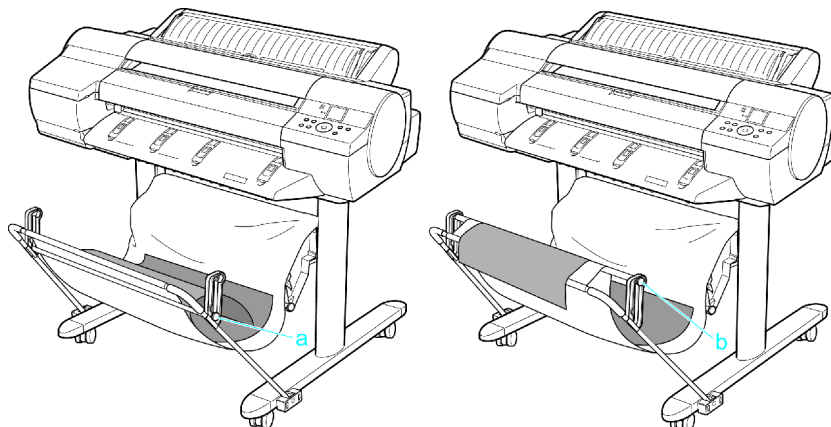

Enhanced Printing Options

Print quality and color settings

☐ Choosing a Paper for Printing

Choosing the right paper for your particular printing application will give you the best printing results.

Media type

The printer and printer driver offer print settings optimized for various paper characteristics.



Note

- For information on the types of paper the printer supports, refer to the Paper Reference Guide. (→P.108)
- The paper type setting in the printer driver and related software (as well as on the Control Panel) is updated when you install the Media Configuration Tool from the User Software CD-ROM or if you change paper information by using the Media Configuration Tool. For information about the Media Configuration Tool, see the Media Configuration Tool Guide (Windows) or Media Configuration Tool Guide (Macintosh).
- An error message is displayed on the printer Control Panel if the paper type as specified in the printer driver does not match the type specified on the printer. Although you can print under these conditions, the printing results may not be suitable.

If the paper type is not listed for selection

If the type of paper loaded cannot be selected, try specifying glossy paper or proofing paper as a special paper (Special 1 to Special 5, in this order). BK (Black Ink) is used as the black ink. Try specifying other types of paper as Special 6 to Special 10. MBK (Matte Black Ink) is used as the black ink. Note that higher numbers in this setting enable more vivid colors but may also cause colors to run together.

For instructions on specifying the paper type before printing, refer to the following topics, as appropriate for your computer and operating system.

- Selecting the Paper Type (Roll) (→P.124)
- Selecting the Paper Type (Sheet) (→P.162)

☐ Giving Priority to Particular Graphic Elements and Colors for Printing

You can specify detailed print settings as desired for the quality level, colors, and other criteria.

Advanced Settings

For printing results that appear just as expected for your original, you can specify which graphic elements and colors to prioritize for printing.



Note

- **Easy Settings** are also available, providing convenient presets. To use the presets, simply choose the printing application.

For details on **Easy Settings**, refer to the following topics.

- Printing Photos and Images (Windows, Mac OS X) (→P.177)
- Printing Photos and Images (Mac OS 9) (→P.179)
- Printing Line Drawings and Text (Windows, Mac OS X) (→P.181)
- Printing Line Drawings and Text (Mac OS 9) (→P.182)
- Printing Office Documents (→P.183)

Print Priority

Choose the graphic elements that you want to emphasize for printing.

Print Priority (*1)	Description
Image	A setting for posters or other documents made up mainly of photos or images, or for emphasizing photos or images in printed documents.
Line Drawing/Text	Choose this setting for CAD drawings made up mainly of intricate lines, or wall newspapers and other notices with a large amount of text. Suitable for emphasizing detailed text in printed documents. However, the quality may not be sufficient when printing photos or images that require a lot of color coverage. In this case, choose “Image” instead.
Office Document	Choose this setting for better legibility of documents combining text and graphics, such as documents and presentation material created with typical office applications.

*1: Options suitable for the selected paper type are listed under Print Priority.

Print Quality

Choose the print quality.

The printing mode is determined by a combination of the print quality and resolution.

Print Quality (*1)	Description	Print Priority
Highest	A setting for printing at the highest resolution when quality is most important. Printing takes longer and consumes more ink than in other modes, but this mode offers superior printing quality.	Image
High	Choose this setting to print at high resolution when quality is most important. Printing takes longer and consumes more ink than in "Standard" or "Draft" modes, but this mode offers exceptional printing quality.	Image Line Drawing/Text
Standard	Choose this setting to print at standard resolution when quality and speed are both important. Printing takes less time than in "Highest" or "High" mode.	Image Line Drawing/Text Office Document
Draft	Choose this setting to print faster. Printing in draft mode can help you work more efficiently when checking layouts.	Image Line Drawing/Text

*1: Options suitable for the selected Print Priority are listed under Print Quality.

Color Settings

Setting Item	Options	Description
Color Mode (*1)	Color Monochrome (Photo) Monochrome	Choose whether to print in color or monochrome. (→P.184)
Color Adjustment (Images)	Cyan Magenta Yellow Brightness Contrast Saturation Gray Tone Adjustment	You can adjust the levels of cyan, magenta, and yellow as well as the brightness, contrast, saturation, and gray tone separately for images, graphics, and text documents. If you choose Monochrome in Color Mode only Brightness and Contrast can be adjusted.
Color Adjustment (Graphics)		
Color Adjustment (Text)		
Gray Adjustment	Color Balance Brightness Contrast Highlight Shadow	Choose the gray tone color balance (Cool Black or Warm Black) and adjust levels of brightness, contrast, highlight, and shadow as desired. These levels can be adjusted when Monochrome (Photo) is selected in Color Mode .
Color-Matching Modes	Driver Matching Mode ICC Matching Mode Off	Choose the color-matching mode. Other color-matching modes may be provided by the computer operating system, such as ICM and ColorSync.
Color-Matching Method (*2)	Auto Perceptual Perceptual (People, Dark Areas) Saturation Colorimetric Others	Choose the color-matching method. The available options vary depending on your selection in "Color-Matching Mode."
Color Space (*3)	sRGB Adobe RGB	Choose a standard color space (sRGB) or an expanded color space (Adobe RGB).

*1: Options suitable for the selected Print Priority are listed under Color Mode.

*2: The order of options displayed varies depending on the operating system.

*3: **Adobe RGB** is not available if an incompatible combination of the paper type and print quality is selected.

Enhancing Printing Quality

Setting Item	Description
Thicken Fine Lines (*1)	Choose this option to make fine lines clearer in CAD drawings or similar documents.
Unidirectional Printing	Choosing unidirectional printing can improve printing results if lines are printed crooked or images are uneven. However, it takes more time than regular printing.
High-Precision Printing	Enables printing at the highest level of quality. However, this requires more time than usual for printing.

*1: Displayed in Windows and Mac OS 9.



Note

- To print at a higher level of quality, in the printer driver, choose **High** or **Highest** in **Print Quality**, and choose **Unidirectional Printing** as the direction of printing.
- For instructions on specifying the print quality and color settings before printing, refer to the following topics, as appropriate for your computer and operating system.
 - Choosing the Document Type and Printing Conditions (Windows) (→P.190)
 - Choosing the Document Type and Printing Conditions (Mac OS X) (→P.192)
 - Choosing the Document Type and Printing Conditions (Mac OS 9) (→P.195)

Printing Photos and Images (Windows, Mac OS X)

Printing is easy when you simply choose the print target.

Easy Settings



Simply choose the printing application in the list for optimal printing results.

Print Target

Choose presets that match the type of document to be printed.

Print targets for photos and images

	Print Target	Description
	Highest Quality	Setting optimized for printing at the highest level of quality.
	Draft	Setting optimized for high-speed draft printing.
	Photo (Photo Studio)	For printing with an effect similar to that produced by photo studios. In subdued, dark photos, images of people and dark scenes are printed attractively.
	Photo (Standard)	Setting optimized for printing photographic images from digital cameras.
	Photo (Adobe RGB)	Setting optimized for printing in colors matching those of images created using the Adobe RGB color space.
	Photo (Monochrome)	Setting optimized for printing monochrome photos in the neutral black image tone of conventional film photographs.
	Poster (Photos)	Suitable for printing posters composed mainly of photographs.

	Print Target	Description
	Poster (Text, Illustrations)	Setting optimized for printing vivid, eye-catching store posters combining images and text.
	Scanned Image	Setting optimized for printing scanned images with accurate color reproduction to match the original images.



Caution

- Depending on the **Media Type** setting, some **Print Target** options may not be available.



Note

- You can check the settings values for each print target by clicking **View Settings**.
- You can also fine-tune these values as needed. (Advanced Settings)
For details on Advanced Settings, see “Giving Priority to Particular Graphic Elements and Colors for Printing”. (→P.173)
- For instructions on printing photos and images, refer to the following topics, as appropriate for your computer and operating system.
 - Printing Photos and Images (Windows) (→P.228)
 - Printing Photos and Images (Mac OS X) (→P.230)

Printing Photos and Images (Mac OS 9)

Printing is easy when you simply choose the print target.







Easy Settings



Simply choose the printing application in the list for optimal printing results.

Print Target

Choose presets that match the type of document to be printed.

Print targets for photos and images

	Print Target	Description
	Highest Quality	Settings optimized for printing at the highest level of quality.
	Photos (High Image Quality)	Setting optimized for printing photographic images at a higher level of quality.
	Photo (from digital camera)	Settings optimized for printing photographic images from digital cameras.
	Photo (Monochrome)	Setting optimized for printing monochrome photos in the neutral black image tone of conventional film photographs.
	Adobe RGB Images	Settings optimized for printing in colors matching those of images created using the Adobe RGB color space.
	Poster (Graphic Image)	Settings optimized for printing posters mainly composed of photos and images.
	POP Ad	Settings optimized for printing vivid, eye-catching store posters combining images and text.

	Print Target	Description
	Scanned Image	Settings optimized for printing scanned images with accurate color reproduction to match the original images.
	Draft	Settings optimized for high-speed draft printing.



Caution

- Depending on the **Media Type** setting, some **Print Target** options may not be available.



Note

- You can check the settings values for each print target by clicking **View Settings**.
- You can also fine-tune these values as needed. (Advanced Settings)
For details on Advanced Settings, see “Giving Priority to Particular Graphic Elements and Colors for Printing”. (→P.173)
- For instructions on printing photos and images, refer to the following topics, as appropriate for your computer and operating system.
 - Printing Photos and Images (Mac OS 9) (→P.179)

Printing Line Drawings and Text (Windows, Mac OS X)

Printing is easy when you simply choose the type of original to print.



Easy Settings

Simply choose the printing application in the list for optimal printing results.

Print Target

Choose presets that match the type of document to be printed.

Print targets for line drawings and text

	Print Target	Description
	Poster (Notice Announcement)	Settings optimized for printing announcements such as wall newspapers and other notices with a large amount of text.
	3D CAD, GIS	Settings optimized for printing 3D CAD drawings, perspective drawings, and maps, including GIS maps.
	CAD (Line Drawing)	Settings optimized to print intricate lines in CAD drawings clearly.



Note

- You can check the settings values for each print target by clicking **View Settings**.
- You can also fine-tune these values as needed. (Advanced Settings)
For details on Advanced Settings, see “Giving Priority to Particular Graphic Elements and Colors for Printing”. (→P.173)

For instructions on printing line drawings and text, refer to the following topics, as appropriate for your computer and operating system.

- Printing Line Drawings and Text (Windows) (→P.215)
- Printing Line Drawings and Text (Mac OS X) (→P.217)

Printing Line Drawings and Text (Mac OS 9)

Printing is easy when you simply choose the type of original to print.



Easy Settings

Simply choose the printing application in the list for optimal printing results.

Print Target

Choose presets that match the type of document to be printed.

Print targets for line drawings and text

	Print Target	Description
	Poster (Notice Announcement)	Settings optimized for printing announcements such as wall newspapers and other notices with a large amount of text.
	3D-CAD/GIS	Settings optimized for printing 3D CAD drawings, perspective drawings, and maps, including GIS maps.
	CAD (Line Drawing)	Settings optimized to print intricate lines in CAD drawings clearly.



Note

- You can check the settings values for each print target by clicking **View Settings**.
- You can also fine-tune these values as needed. (Advanced Settings)
For details on Advanced Settings, see “Giving Priority to Particular Graphic Elements and Colors for Printing”. (→P.173)

For instructions on printing line drawings and text, refer to the following topics, as appropriate for your computer and operating system.

- Printing Line Drawings and Text (Mac OS 9) (→P.182)

Printing Office Documents

Printing is easy when you simply choose the type of original to print.

Easy Settings

Simply choose the printing application in the list for optimal printing results.

Print Target

Choose presets that match the type of document to be printed.

Print targets for office documents

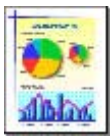
	Print Target	Description
	Office Document	Settings optimized for clear printing of office documents such as handouts.



Note

- You can check the settings values for each print target by clicking **View Settings**.
- You can also fine-tune these values as needed. (Advanced Settings)
For details on Advanced Settings, see “Giving Priority to Particular Graphic Elements and Colors for Printing”. (→P.173)

For instructions on printing office documents, refer to the following topics, as appropriate for your computer and operating system.

- Printing Office Documents (Windows) (→P.222)
- Printing Office Documents (Mac OS X) (→P.224)
- Printing Office Documents (Mac OS 9) (→P.226)

Adjusting the Color in the Printer Driver

Color settings specified in the application for your documents are essentially given priority over other settings for each print job, but further color adjustment is possible in the printer driver.

Color Mode

Choose how the printer driver processes color, as desired.

The available options vary depending on the color mode.

Color Mode	Description	Color Adjustment
Color	Print in color.	You can adjust the color balance and color-matching method.
Monochrome (Photo)	Grayscale printing optimized for monochrome photos.	You can adjust the color balance in ways tailored to monochrome photos.
Monochrome	Print in grayscale.	You can adjust the color balance.

Color Adjustment

You can adjust colors separately for images, graphics, and text documents.

Adjustment Item	Description
Cyan	Correct color tones by adjusting the levels of Cyan , Magenta , and Yellow .
Magenta	
Yellow	
Brightness	Adjust the brightness of printed images while keeping the darkest and lightest portions intact.
Contrast	Adjust the contrast of the darkest and lightest portions relative to each other. For soft gradation, decrease the contrast. For hard gradation, increase the contrast.
Saturation	Adjust the level of color saturation, in a range from subdued to vivid.
Gray Tone Adjustment (Gray Tone)	Adjust the grayscale, in a range from cool, blue tones to warm, red tones.

Matching

You can choose the color-matching mode and method.

By adjusting the color-matching mode and method, you can make printed colors match the colors of on-screen images more closely.

Matching Mode	Description	Notes
Driver Matching Mode	Color adjustment based on the original color profile of the printer driver	This is the default color-matching method. Normally, use Driver Matching Mode .
ICC Matching Mode	Color adjustment based on ICC color profiles (an international standard) using the printer driver	You can select the printer profile in the Printer Profile Settings list.
Driver ICM Mode	Color adjustment based on the standard Windows ICM function. The printer driver adjusts the colors.	Available when using Windows 2000, Windows XP, or Windows Server 2003/Windows Vista
Host ICM Mode	Color adjustment based on the standard Windows ICM function. Windows adjusts the colors.	
ColorSync	Color adjustment based on the standard Mac OS ColorSync function. Mac OS adjusts the colors.	Available when using the Mac OS
Off (No Correction)	No color-matching	Choose this option for color-matching by the software application or with your own color profile, when you want to disable color-matching by the printer driver.

Matching Method	Description	Notes
Auto	Color-matching optimized for images, graphics, or text	The available options and their display order varies depending on your selection in Color-Matching Mode, as well as the operating system.
Perceptual	Color-matching optimized for photos. Print images with smooth gradations and colors closer to those as displayed on the screen.	
Perceptual (People, Dark Areas)	Color matching optimized for printing skin tone and dark areas attractively in subdued, dark photos. For printing indoor shots of people or evening scenes attractively.	
Colorimetric	Color-matching with adjustment to remove color from white area. Without white adjustment, colors are added to white area.	
Colorimetric (No Wht-pnt Corr)	Color-matching without white adjustment to reflect the profile of original data. Without white adjustment, colors are added to white area.	
Saturation	Color-matching optimized for graphics. This option emphasizes color saturation.	

Gray Tone Adjustment

The following settings can be adjusted if “Monochrome (Photo)” is selected in Color Mode.

Gray Adjustment Items	Description
Color Balance	Enables you to adjust the gray tone to suit the images of monochrome photos. Choose cool black (tinged with blue), pure black (neutral), warm black (tinged with red), and so on. Select the color tone in the color region or from the list.
Brightness	Adjust the brightness of printed images while keeping the darkest and lightest portions intact.
Contrast	Adjust the contrast of the darkest and lightest portions relative to each other. For soft gradation, decrease the contrast. For hard gradation, increase the contrast.
Highlight	Adjust levels of image highlight areas.
Shadow	Adjust levels of image shadow areas.



Note

- Be sure to calibrate your monitor colors correctly if you adjust the colors for printing. If monitor colors are not calibrated correctly, you may not obtain the desired printing results. For instructions on monitor calibration, refer to the documentation for your monitor and operating system.

For instructions on color adjustment, refer to the following topics, as appropriate for your computer and operating system.

- Fine-Tuning Colors of Photos and Images (Windows) (→P.198)
- Fine-Tuning Colors of Photos and Images (Mac OS X) (→P.201)
- Fine-Tuning Colors of Photos and Images (Mac OS 9) (→P.204)

■ ■ ■ Printing in Ideal Colors for Light in the Viewing Environment

You can print in the colors that look best when viewed under the light where the printed image will be displayed. There are two ways to adjust the color tone for the ambient light, as follows.

By selecting color tones on Charts before printing

On the printed **Chart**, note the number of the set of colors with the desired color tone and enter this number in the printer driver before printing.



Important

- This function requires that the **Light Source Check Tool** be installed.
- You can install the **Light Source Check Tool** from the User Software CD-ROM.
- This function is only supported in Windows.

For instructions on selecting color tones on **Charts** before printing, refer to the following topic:

- By selecting color tones on Charts before printing (Windows) (→P.604)

Printing in Colors Matching the Measured Ambient Light

Measure the light level in the viewing environment and enter the results in the printer driver before printing.



Important

- This function requires the Eye-One spectrophotometer. The Light Source Measure Tool must also be installed.
- You can install the Light Source Measure Tool from the User Software CD-ROM.
- For a list of supported Eye-One devices, refer to the manual provided with the Light Source Measure Tool.
- This function is only supported in Windows.

For instructions on measuring light levels before printing, refer to the following topic:

- Printing in Colors Matching the Measured Ambient Light (→P.608)

☐ Printing Photos in Monochrome

The following settings are available for monochrome printing.

Main	Easy Settings	Print Target	Photo (Monochrome)	<p>A mode optimized for printing monochrome images with maximum expressiveness through simple operations. Choosing Photo (Monochrome) in Easy Settings applies image processing to keep color ink use to an absolute minimum, suppressing color shift and achieving consistent gray balance.</p> <ul style="list-style-type: none"> • Photo (Monochrome) is not available for all types of paper. • Printing that matches the pure neutral black of conventional photos (silver-halide prints) is possible. <p>Printing Photos in Monochrome (Windows) (→P.236) Printing Photos in Monochrome (Mac OS X) (→P.238) Printing Photos in Monochrome (Mac OS 9) (→P.241)</p>
	Advanced Settings	Color Mode	Monochrome (Photo)	<p>A mode for printing monochrome images with maximum expressiveness by specifying detailed settings. In these settings, you can specify to apply image processing to keep color ink use to an absolute minimum, suppress color shift, and achieve consistent gray balance. You can also fine-tune the color balance by selecting “Warm Black,” “Cool Black”, and so on.</p> <ul style="list-style-type: none"> • Even more detailed adjustment is possible on the Color Adjustment sheet. • Monochrome (Photo) is not available for all types of paper. <p>Fine-Tuning Monochrome Settings When Printing Photos (Windows) (→P.207) Fine-Tuning Monochrome Settings When Printing Photos (Mac OS X) (→P.209) Fine-Tuning Monochrome Settings When Printing Photos (Mac OS 9) (→P.212)</p>
			Monochrome	<p>Deactivates color printing so that images are printed in monochrome, with continuous-tone color data printed using gray midtones. Use this mode to print office documents or graphics in monochrome, or if the paper is not compatible with the Monochrome (Photo) setting.</p> <ul style="list-style-type: none"> • Even more detailed adjustment is possible on the Color Adjustment sheet. • If the paper is not compatible with the Monochrome (Photo) setting, choose Monochrome . • Because color ink is used to produce gray continuous-tone images, the gray may appear to have a tinge of color. <p>Fine-Tuning Monochrome Settings When Printing Photos (Windows) (→P.207) Fine-Tuning Monochrome Settings When Printing Photos (Mac OS X) (→P.209) Fine-Tuning Monochrome Settings When Printing Photos (Mac OS 9) (→P.212)</p>

☐ Choosing the Document Type and Printing Conditions (Windows)

You can specify your own print settings instead of using the **Print Target** presets. This topic describes how to print CAD drawings in monochrome.

1. Choose **Print** in the application menu.
2. Select the printer in the dialog box, and then display the printer driver dialog box. (→P.473)
3. Make sure the **Main** sheet is displayed.

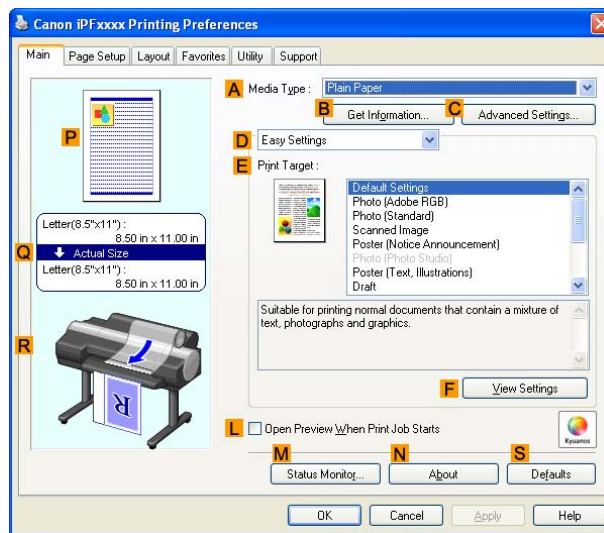

4. In the **A Media Type** list, select the type of paper that is loaded.
5. Click **D Advanced Settings** to switch the print mode.

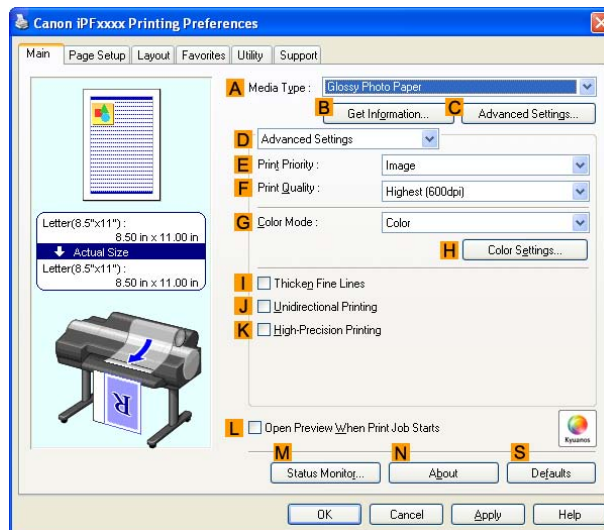

6. Click **Line Drawing/Text** in the **E Print Priority** list.
7. Click **Standard (600dpi)** in the **F Print Quality** list.



Note

- Options displayed in the **F Print Quality** list vary depending on the paper type.

8. Click **Monochrome** in the **G Color Mode** list.
9. To adjust the brightness and contrast, click **H Color Settings**.



Note

- For instructions on adjusting brightness and contrast, see “Adjusting the Color in the Printer Driver”. (→P.184)

10. Click the **Page Setup** tab to display the **Page Setup** sheet.

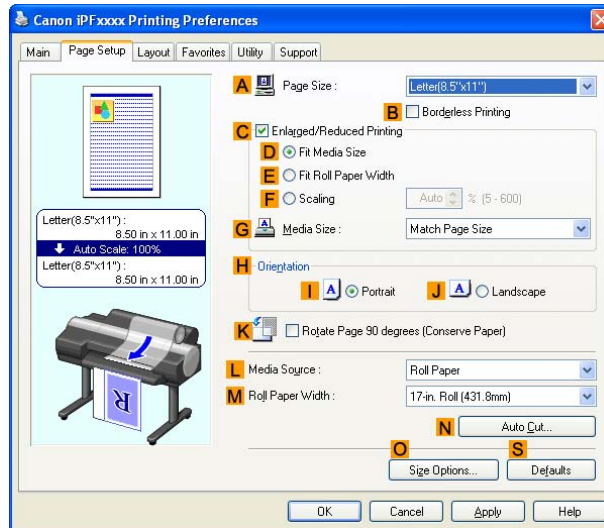

11. Confirm the settings of **A Page Size**, **L Media Source**, and so on.
12. Confirm the print settings and print as desired.



Note

- For tips on confirming print settings, see “Confirming Print Settings (Windows)”. (→P.443)

☐ Choosing the Document Type and Printing Conditions (Mac OS X)

You can specify your own print settings instead of using the **Print Target** presets. This topic describes how to print CAD drawings in monochrome.

1. Choose **Page Setup** from the application menu to display the **Page Attribute** dialog box.

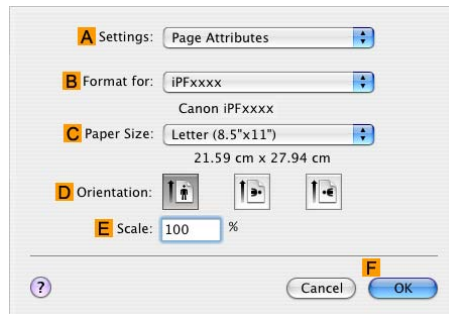

2. Select the printer in the **B Format for** list.
3. Choose the original size in the **C Paper Size** list.
4. Click **F OK** to close the dialog box.
5. In the application menu, choose **Print**.
6. Access the **Main** pane.

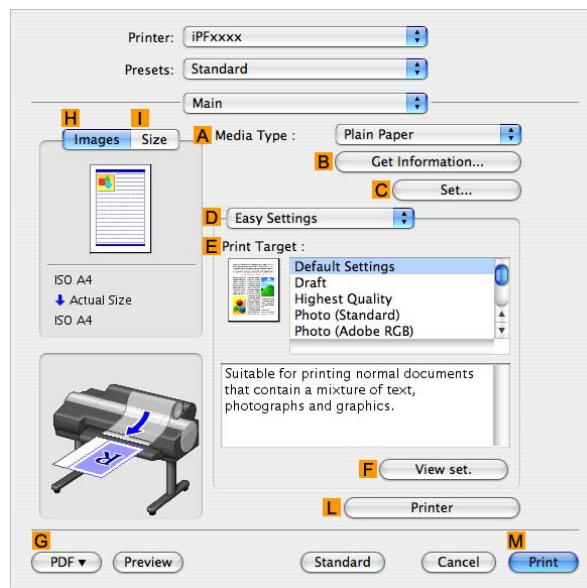

7. In the **A Media Type** list, select the type of paper that is loaded.

8. Click **D Advanced Settings** to switch the print mode.

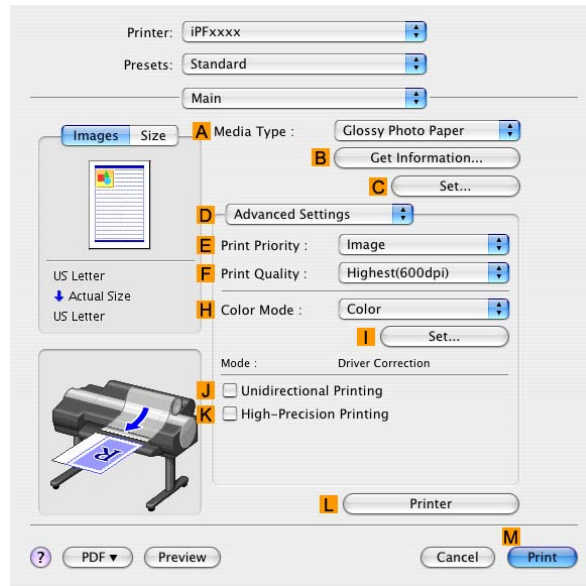

9. Click **Line Drawing** in the **E Print Priority** list.

10. Click **Standard(600dpi)** in the **F Print Quality** list.



Note

- Options displayed in the **F Print Quality** list vary depending on the paper type.

11. Click **Monochrome** in the **H Color Mode** list.

12. To adjust the brightness and contrast, click **I Set**.



Note

- For instructions on adjusting brightness and contrast, see “Adjusting the Color in the Printer Driver”. (→P.184)

13. Access the **Page Setup** pane.

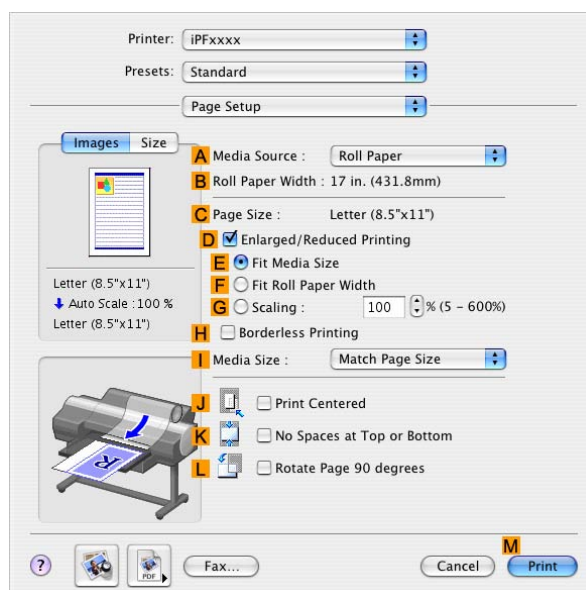

Print quality and color settings

14. Confirm the settings of **A Media Source** and **C Page Size**.
15. Confirm the print settings, and then click **M Print** to start printing.



Note

- For tips on confirming print settings, see “Confirming Print Settings (Mac OS X)”. (→P.493)

☐ Choosing the Document Type and Printing Conditions (Mac OS 9)

You can specify your own print settings instead of using the **Print Target** presets. This topic describes how to print CAD drawings in monochrome.

1. Select the printer in **Chooser**.
2. Choose **Page Setup** from the application menu to display the **Page Attribute** dialog box.

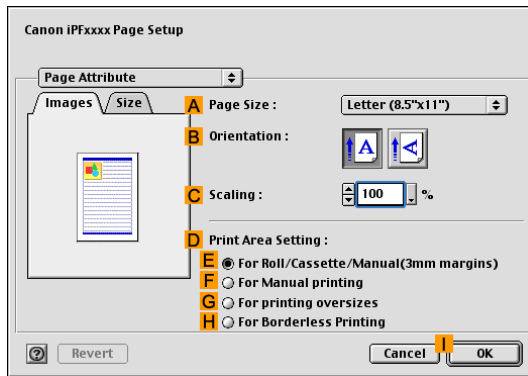

3. Choose the original size in the **A Page Size** list.
4. Click **I OK** to close the dialog box.
5. In the application menu, choose **Print**.
6. Make sure the **Main** pane is displayed.

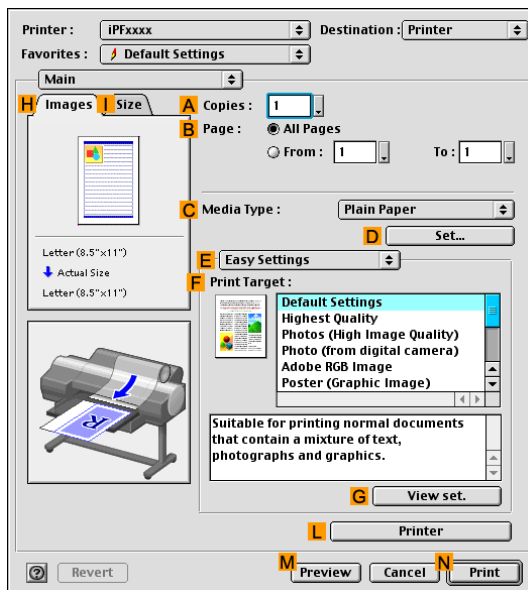

7. In the **C Media Type** list, select the type of paper that is loaded.

8. Click **E Advanced Settings** to switch the print mode.

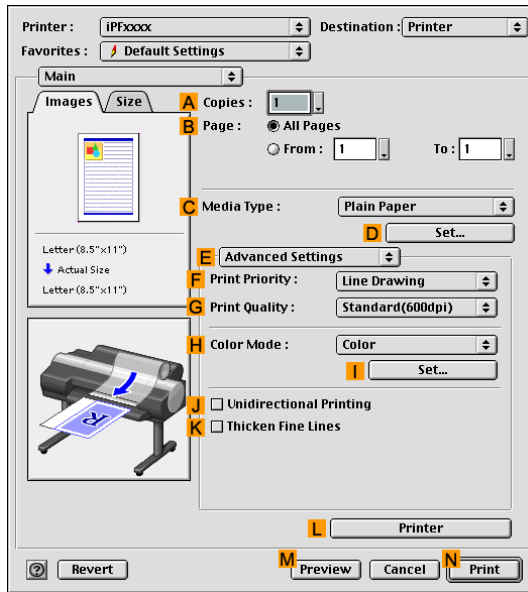

9. Click **Line Drawing** in the **F Print Priority** list.

10. Click **Standard(600dpi)** in the **G Print Quality** list.



Note

- Options displayed in the **G Print Quality** list vary depending on the paper type.

11. Click **Monochrome** in the **H Color Mode** list.

12. To adjust brightness and contrast, click **I Set**.



Note

- For instructions on adjusting brightness and contrast, see “Adjusting the Color in the Printer Driver”. (→P.184)

13. Access the **Finishing** pane.

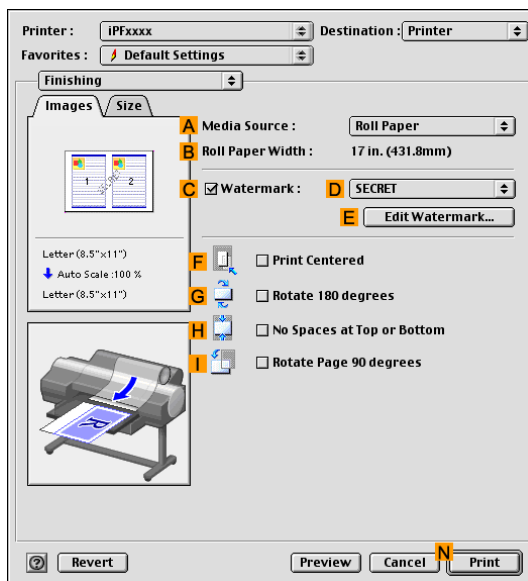

14. Confirm the selection in **A Media Source**.
15. Confirm the print settings, and then click **N Print** to start printing.



Note

- For tips on confirming print settings, see “Confirming Print Settings (Mac OS 9)”. (→P.518)

Fine-Tuning Colors of Photos and Images (Windows)

You can specify your own print settings instead of using the **Print Target** presets. This topic describes how to fine-tune the color tone of photos before printing.

1. Choose **Print** in the application menu.
2. Select the printer in the dialog box, and then display the printer driver dialog box. (→P.473)
3. Make sure the **Main** sheet is displayed.

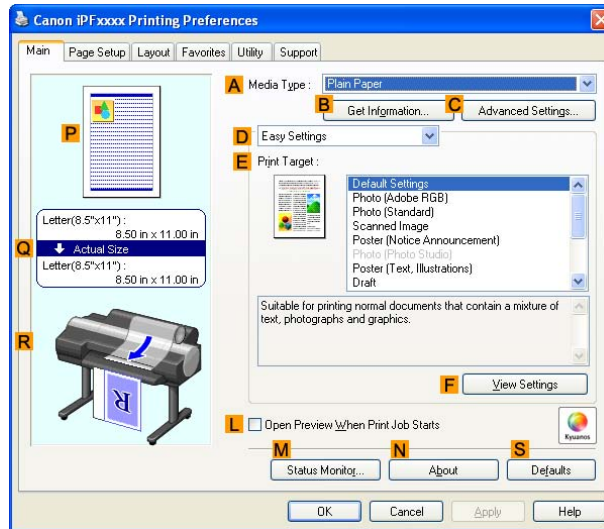

4. In the **A Media Type** list, select the type of paper that is loaded.
5. Click **D Advanced Settings** to switch the print mode.

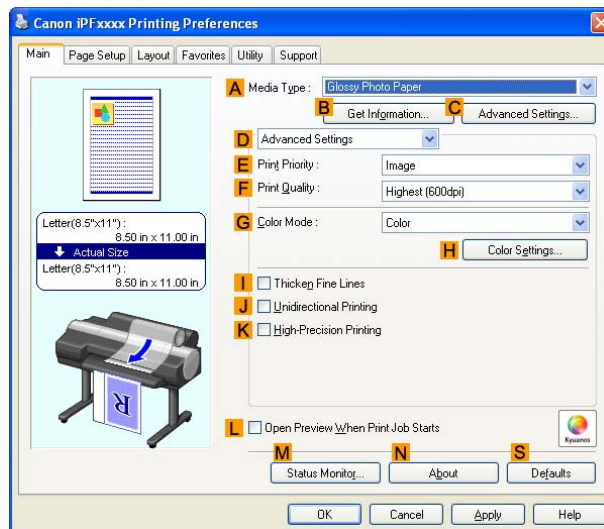

6. Click **Color** in the **G Color Mode** list.

7. Click **H Color Settings** to display the **Color Settings** dialog box.

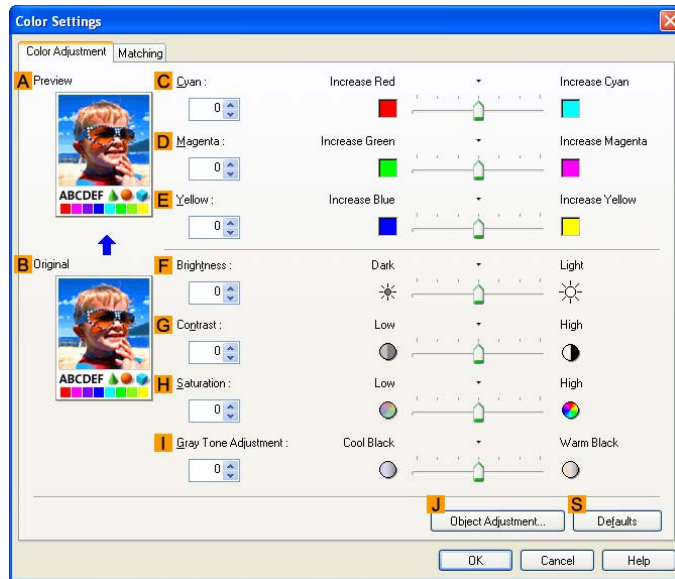

8. On the **Color Adjustment** sheet, adjust the color tones, brightness, and so on as desired.

Adjustment Item	Description
C Cyan	Correct color tones by adjusting the levels of Cyan , Magenta , and Yellow .
D Magenta	
E Yellow	
F Brightness	Adjust the brightness of printed images while keeping the darkest and lightest portions intact.
G Contrast	Adjust the contrast of the darkest and lightest portions relative to each other. For soft gradation, decrease the contrast. For hard gradation, increase the contrast.
H Saturation	Adjust the level of color saturation, in a range from subdued to vivid.
I Gray Tone Adjustment	Adjust the gray tone to suit the images of monochrome photos. Choose cool black (tinged with blue), pure black (neutral), warm black (tinged with red), and so on. Select the color tone in the color region or from the list.

9. Close the **Color Settings** dialog box.

10. Click the **Page Setup** tab to display the **Page Setup** sheet.

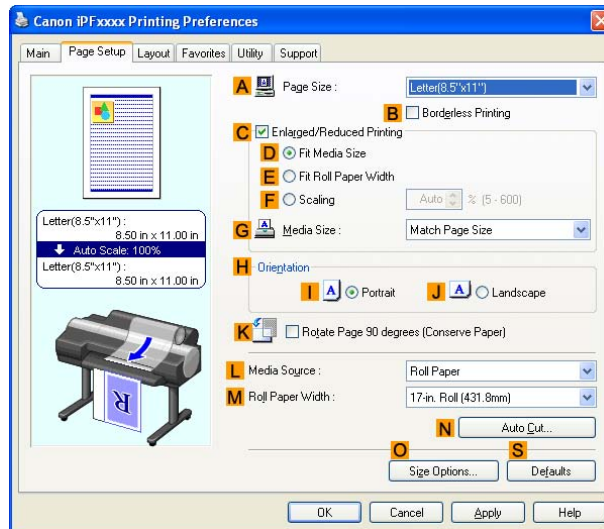

11. Confirm the settings of **A Page Size**, **L Media Source**, and so on.

12. Confirm the print settings and print as desired.



Note

- For instructions on confirming print settings, see “Confirming Print Settings (Windows)”. (→P.443)

Fine-Tuning Colors of Photos and Images (Mac OS X)

You can specify your own print settings instead of using the **Print Target** presets. This topic describes how to fine-tune the color tone of photos before printing.

1. Choose **Page Setup** from the application menu to display the **Page Attribute** dialog box.

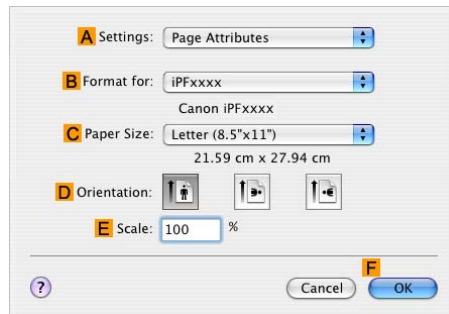

2. Select the printer in the **B Format for** list.
3. Choose the original size in the **C Paper Size** list.
4. Click **F OK** to close the dialog box.
5. Choose **Print** in the application menu.
6. Access the **Main** pane.

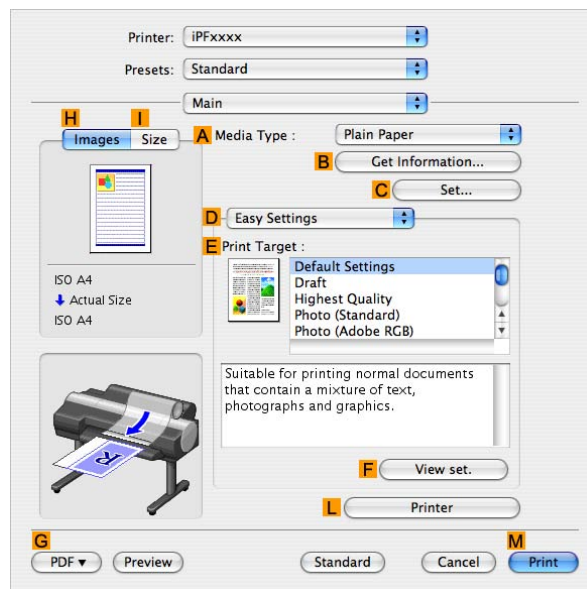

7. In the **A Media Type** list, select the type of paper that is loaded.

8. Click **D** **Advanced Settings** to switch the print mode.

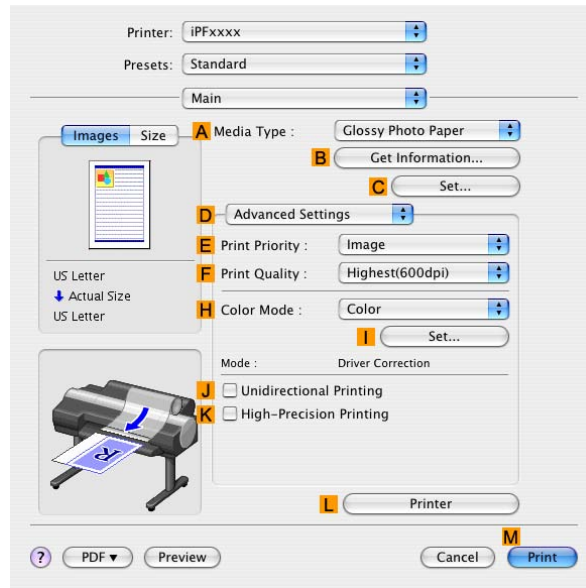

9. Click **Color** in the **H** **Color Mode** list.

10. Click **I** **Set** to display the **Color Settings** dialog box.

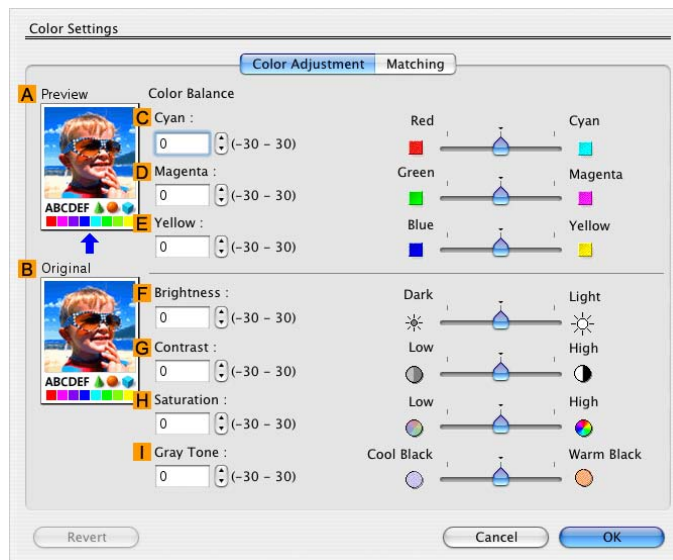

11. On the **Color Adjustment** pane, adjust the color tones, brightness, and so on as desired.

Adjustment Item	Description
C Cyan	Correct color tones by adjusting the levels of Cyan , Magenta , and Yellow .
D Magenta	
E Yellow	
F Brightness	Adjust the brightness of printed images while keeping the darkest and lightest portions intact.
G Contrast	Adjust the contrast of the darkest and lightest portions relative to each other. For soft gradation, decrease the contrast. For hard gradation, increase the contrast.
H Saturation	Adjust the level of color saturation, in a range from subdued to vivid.
I Gray Tone	Adjust the gray tone to suit the images of monochrome photos. Choose cool black (tinged with blue), pure black (neutral), warm black (tinged with red), and so on. Select the color tone in the color region or from the list.

12. Click **OK** to close the **Color Settings** dialog box.

13. Access the **Page Setup** pane.

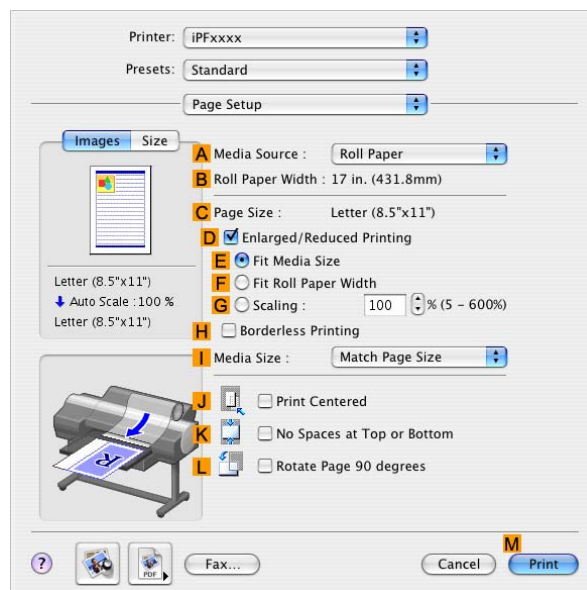

14. Confirm the settings of **A Media Source** and **C Page Size**.

15. Confirm the print settings, and then click **M Print** to start printing.



Note

- For instructions on confirming print settings, see “Confirming Print Settings (Mac OS X)”. (→P.493)

Fine-Tuning Colors of Photos and Images (Mac OS 9)

You can specify your own print settings instead of using the **Print Target** presets. This topic describes how to fine-tune the color tone of photos before printing.

1. Select the printer in **Chooser**.
2. Choose **Page Setup** from the application menu to display the **Page Attribute** dialog box.

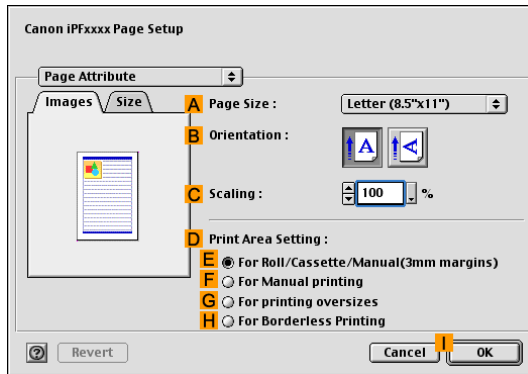

3. Choose the original size in the **A Page Size** list.
4. Click **I OK** to close the dialog box.
5. Choose **Print** in the application menu.
6. Make sure the **Main** pane is displayed.

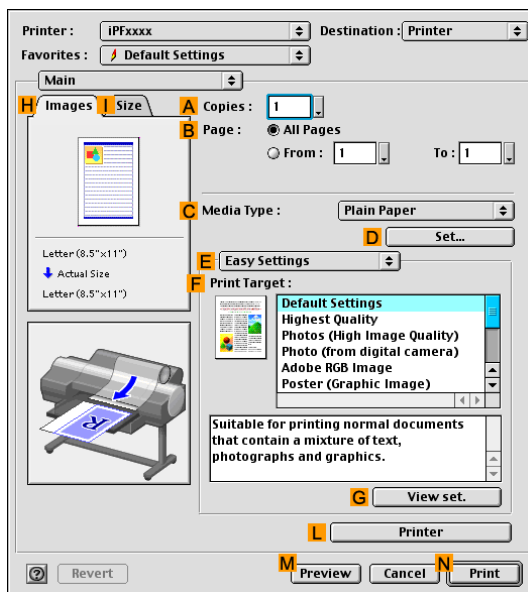

7. In the **C Media Type** list, select the type of paper that is loaded.

8. Click **E** **Advanced Settings** to switch the print mode.

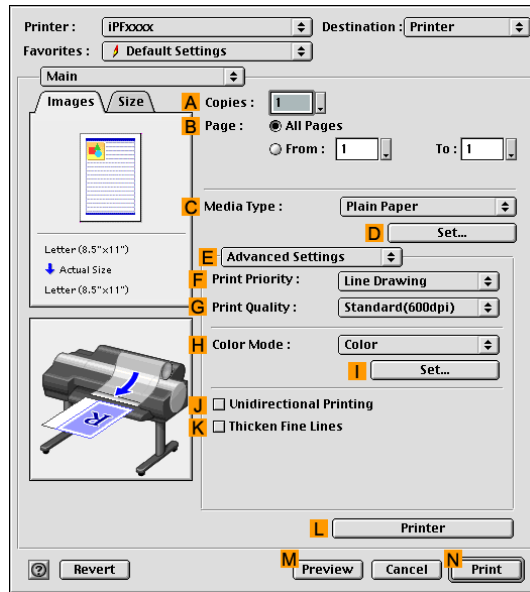

9. Click **Color** in the **H** **Color Mode** list.

10. Click **I** **Set** to display the **Color Settings** dialog box.

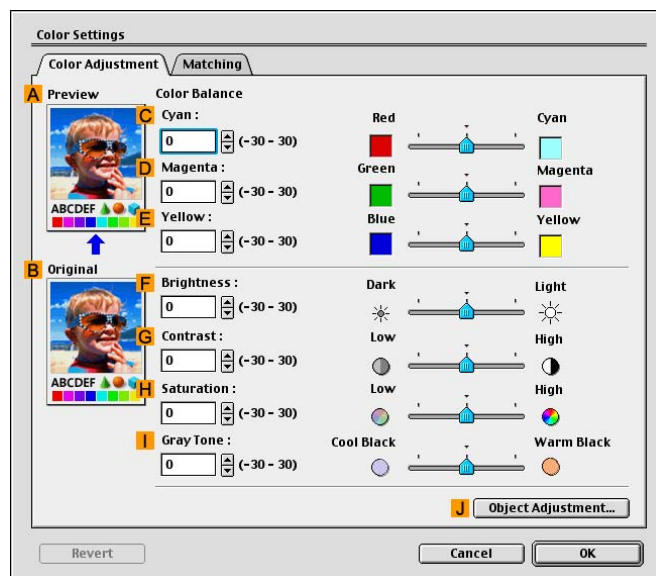

11. On the **Color Adjustment** pane, adjust the color tones, brightness, and so on as desired.

Adjustment Item	Description
C Cyan	Correct color tones by adjusting the levels of Cyan , Magenta , and Yellow .
D Magenta	
E Yellow	
F Brightness	Adjust the brightness of printed images while keeping the darkest and lightest portions intact.
G Contrast	Adjust the contrast of the darkest and lightest portions relative to each other. For soft gradation, decrease the contrast. For hard gradation, increase the contrast.
H Saturation	Adjust the level of color saturation, in a range from subdued to vivid.
I Gray Tone	Adjust the gray tone to suit the images of monochrome photos. Choose cool black (tinged with blue), pure black (neutral), warm black (tinged with red), and so on. Select the color tone in the color region or from the list.

12. Click **OK** to close the **Color Settings** dialog box.

13. Access the **Finishing** pane.

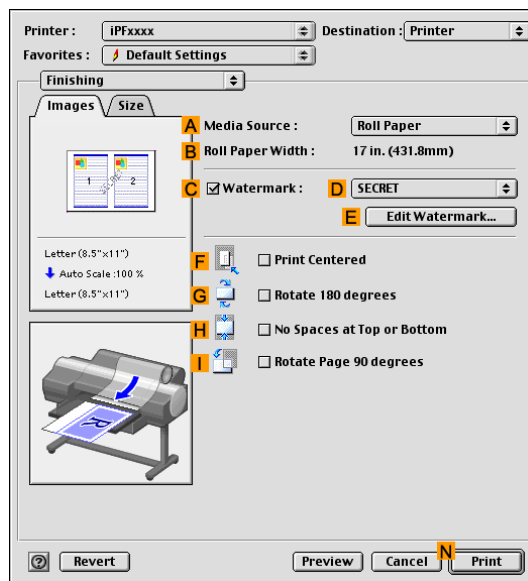

14. Confirm the selection in **A Media Source**.

15. Confirm the print settings, and then click **N Print** to start printing.



Note

- For tips on confirming print settings, see “Confirming Print Settings (Mac OS 9)”. (→P.518)

Fine-Tuning Monochrome Settings When Printing Photos (Windows)

You can specify your own print settings instead of using the **Print Target** presets. This topic describes how to fine-tune monochrome settings before printing.

1. Choose **Print** in the application menu.
2. Select the printer in the dialog box, and then display the printer driver dialog box. (→P.473)
3. Make sure the **Main** sheet is displayed.

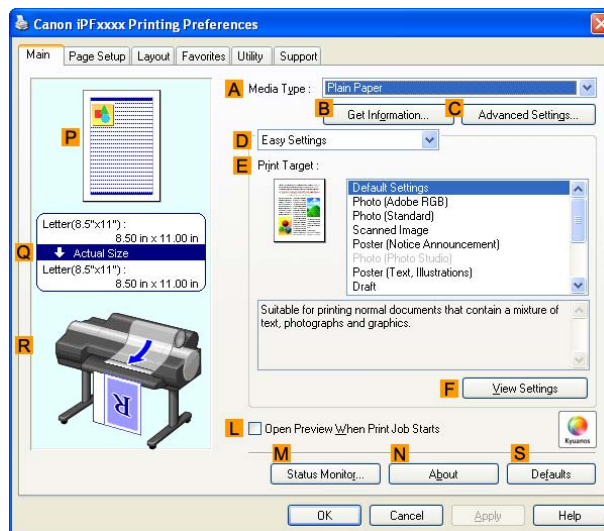

4. In the **A Media Type** list, select the type of paper that is loaded.
5. Click **D Advanced Settings** to switch the print mode.

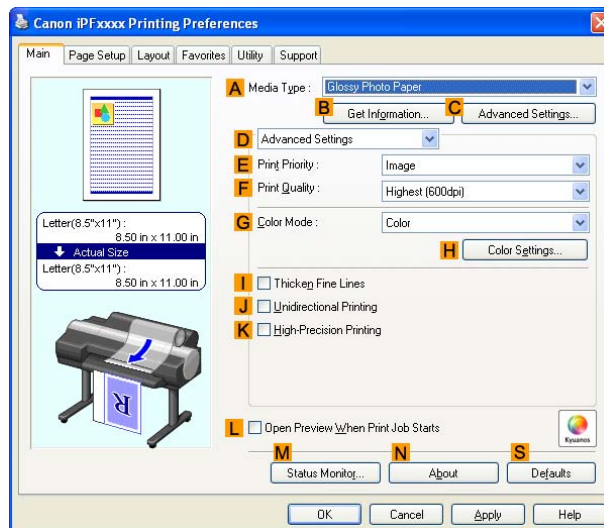

6. Click **Monochrome (Photo)** in the **G Color Mode** list.



Note

- **Monochrome (Photo)** may not be available for all types of paper.

7. Click **H Color Settings** to display the **Color Settings** dialog box.

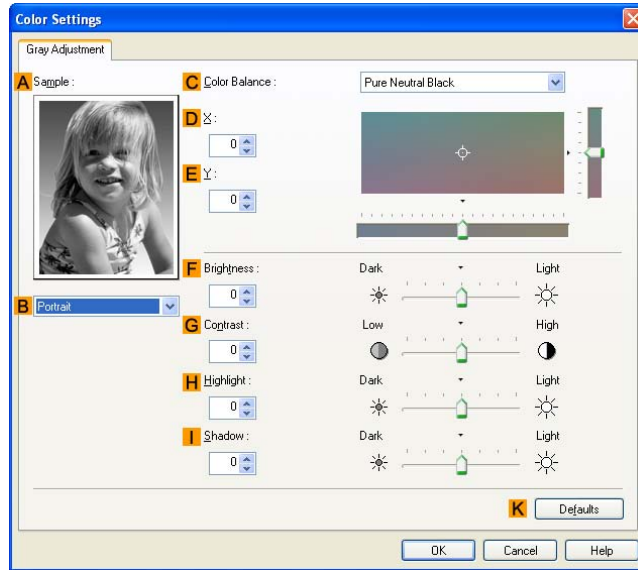

8. On the **Gray Adjustment** sheet, adjust the color tones, brightness, and so on as desired.

9. Close the **Color Settings** dialog box.

10. Click the **Page Setup** tab to display the **Page Setup** sheet.

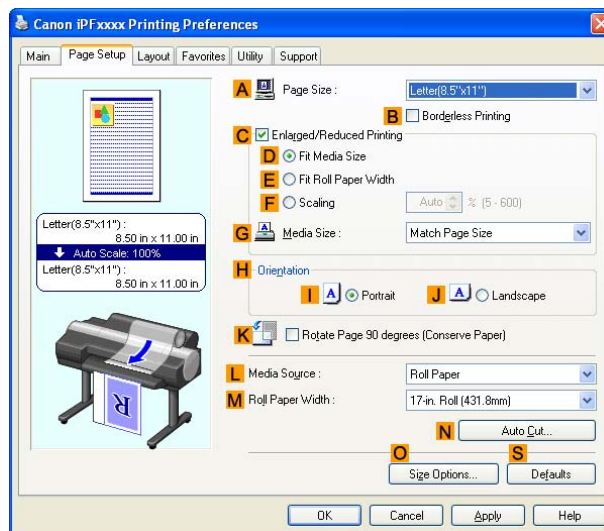

11. Confirm the settings of **A Page Size**, **L Media Source**, and so on.

12. Confirm the print settings and print as desired.



Note

- For tips on confirming print settings, see "Confirming Print Settings (Windows)". (→P.443)

Fine-Tuning Monochrome Settings When Printing Photos (Mac OS X)

You can specify your own print settings instead of using the **Print Target** presets. This topic describes how to fine-tune monochrome settings before printing.

1. Choose **Page Setup** from the application menu to display the **Page Attribute** dialog box.

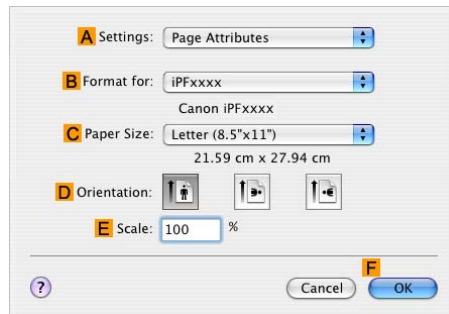

2. Select the print target in the **B Format for** list.
3. Choose the original size in the **C Paper Size** list.
4. Click **F OK** to close the dialog box.
5. In the source application menu, choose **Print**.
6. Access the **Main** pane.

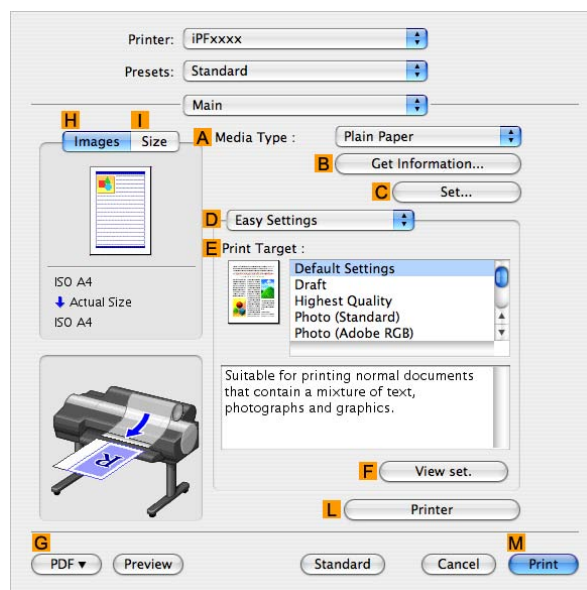

7. In the **A Media Type** list, select the type of paper that is loaded.

8. Click **D Advanced Settings** to switch the print mode.

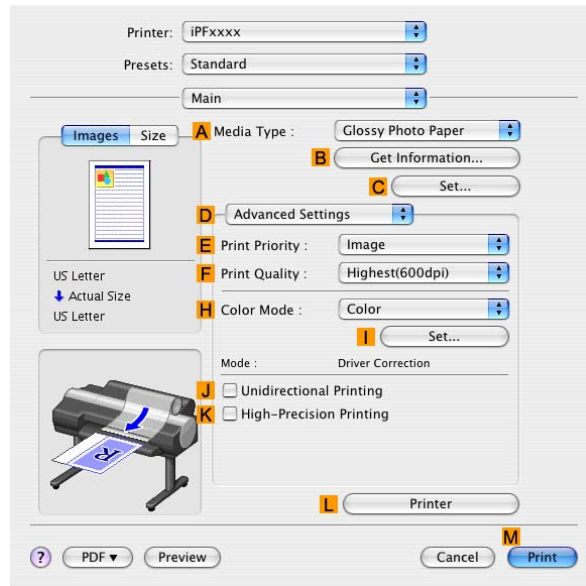

9. Click **Monochrome (Photo)** in the **H Color Mode** list.



Note

- **Monochrome (Photo)** may not be available for all types of paper.

10. Click **I Set** to display the **Color Settings** dialog box.

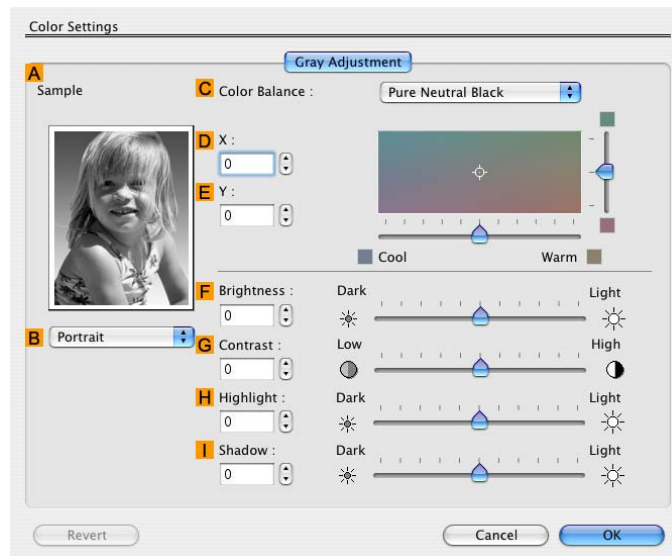

11. On the **Gray Adjustment** pane, adjust the color tones, brightness, and so on as desired.

12. Click **OK** to close the **Color Settings** dialog box.

13. Access the **Page Setup** pane.

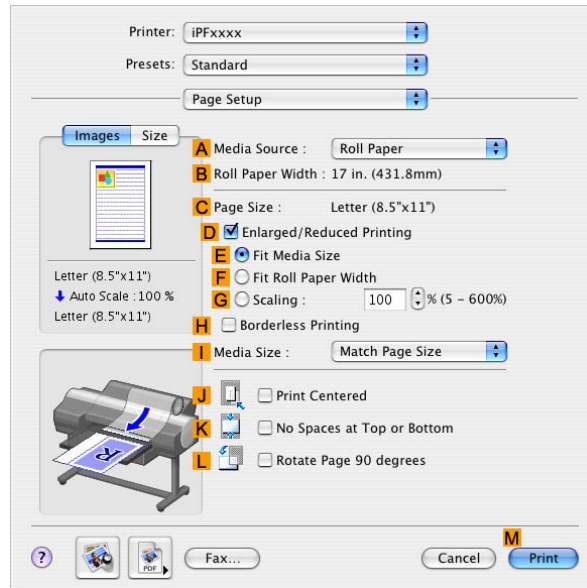

14. Confirm the settings of **A Media Source** and **C Page Size**.

15. Confirm the print settings, and then click **M Print** to start printing.



Note

- For tips on confirming print settings, see “Confirming Print Settings (Mac OS X)”. (→P.493)

Fine-Tuning Monochrome Settings When Printing Photos (Mac OS 9)

You can specify your own print settings instead of using the **Print Target** presets. This topic describes how to fine-tune monochrome settings before printing.

1. Select the printer in **Chooser**.
2. Choose **Page Setup** from the application menu to display the **Page Attribute** dialog box.

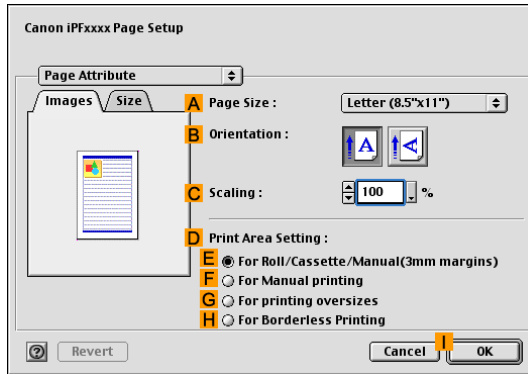

3. Choose the original size in the **A Page Size** list.
4. Click **I OK** to close the dialog box.
5. In the source application menu, choose **Print**.
6. Make sure the **Main** pane is displayed.

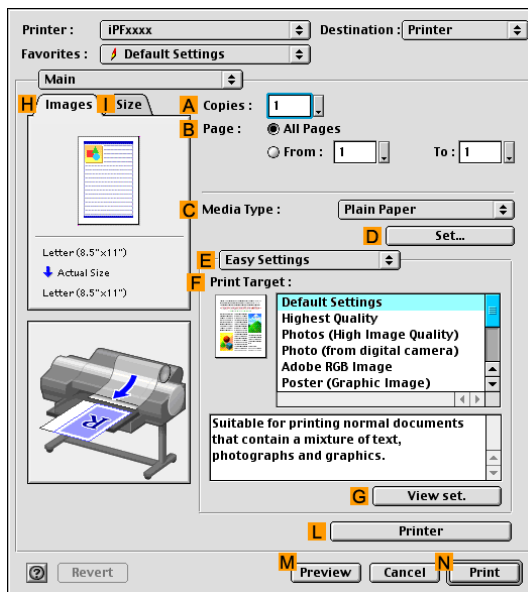

7. In the **C Media Type** list, select the type of paper that is loaded.

8. Click **E** **Advanced Settings** to switch the print mode.

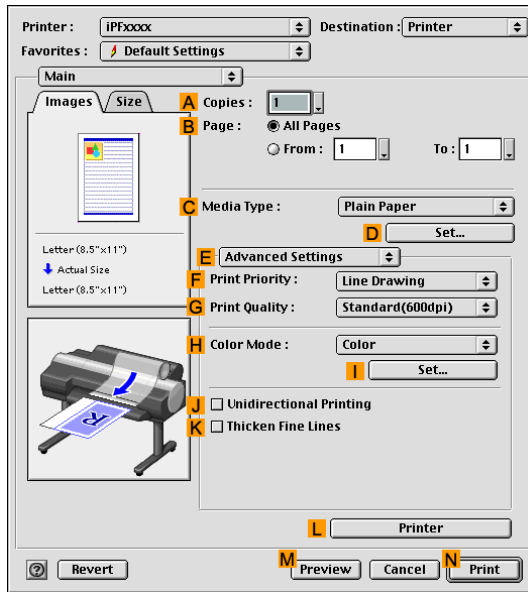

9. Click **Monochrome (Photo)** in the **H** **Color Mode** list.



Note

- **Monochrome (Photo)** may not be available for all types of paper.

10. Click **I** **Set** to display the **Color Settings** dialog box.

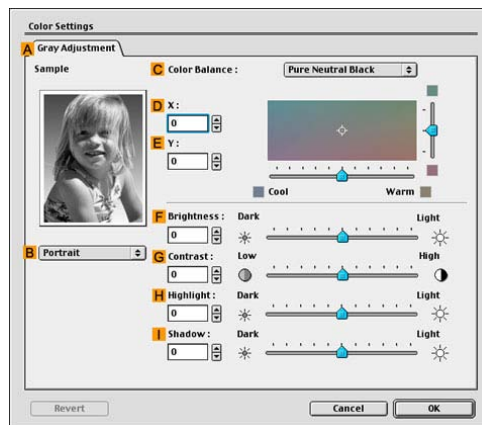

11. On the **Gray Tone Adjustment** pane, adjust the color tones, brightness, and so on as desired.

12. Access the **Finishing** pane.

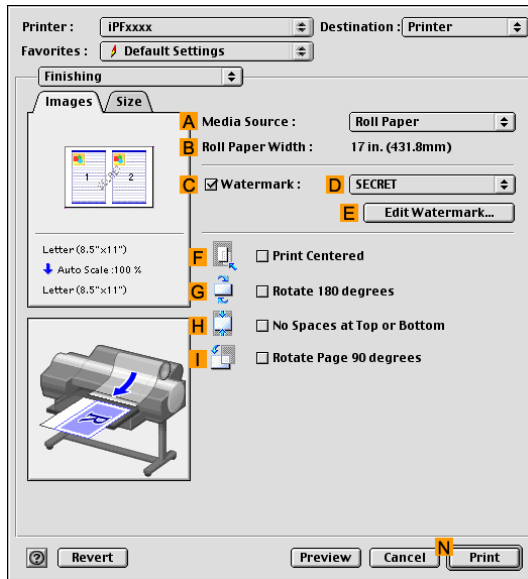

13. Confirm the selection in **A Media Source**.

14. Confirm the print settings, and then click **N Print** to start printing.



Note

- For tips on confirming print settings, see “Confirming Print Settings (Mac OS 9)”. (→P.518)

Printing Line Drawings and Text (Windows)

This topic describes how to print line drawings based on the following example.

- Document: CAD drawing
- Page size: A3 (297.0 × 420.0 mm [11.7 × 16.5 in])
- Paper: Roll
- Paper type: Plain Paper
- Roll paper width: A2/A3 roll (420.0 mm [16.5 in])

1. Choose **Print** in the application menu.
2. Select the printer in the dialog box, and then open the printer driver dialog box. (→P.473)
3. Make sure the **Main** sheet is displayed.

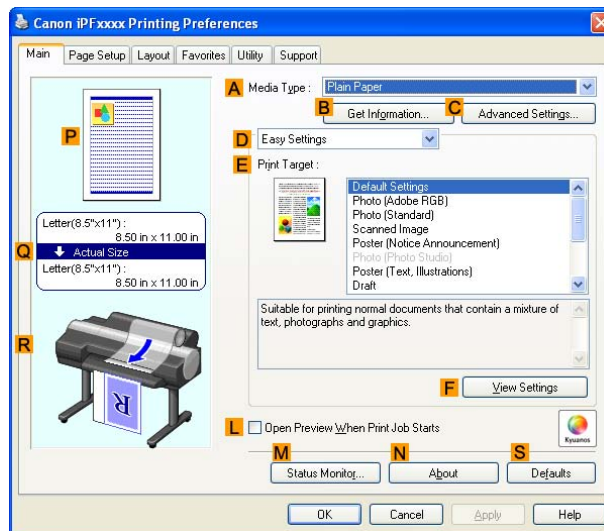

4. In the **A Media Type** list, select the type of paper that is loaded. In this case, click Plain Paper.
5. After confirming that **D Easy Settings** is selected, click **CAD (Line Drawing)** in the **E Print Target** list.



Note

- You can check the settings values selected in the **E Print Target** list by clicking **F View Settings**.

6. Click the **Page Setup** tab to display the **Page Setup** sheet.

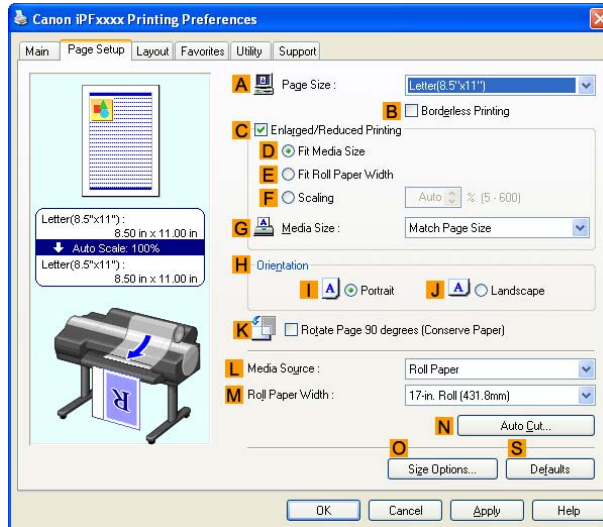

7. In **A Page Size**, click the size of the original as specified in the application software. In this case, click **ISO A3**.
8. Click **Roll Paper** in the **L Media Source** list.
9. Select the width of the loaded roll in the **M Roll Paper Width** list-in this case, **ISO A2/A3 Roll (420.0mm)**.
10. Specify additional printing conditions.
For details on available printing conditions, see "Printer Driver Settings (Windows)". (→P.441)
11. Confirm the print settings and print as desired.



Note

- For tips on confirming print settings, see "Confirming Print Settings (Windows)". (→P.443)

Printing Line Drawings and Text (Mac OS X)

This topic describes how to print line drawings based on the following example.

- Document: CAD drawing
- Page size: A3 (297.0 × 420.0 mm [11.7 × 16.5 in])
- Paper: Roll
- Paper type: Plain Paper
- Roll paper width: A2/A3 roll (420.0 mm [16.5 in])

1. Choose **Page Setup** in the application menu to display the **Page Attribute** dialog box.

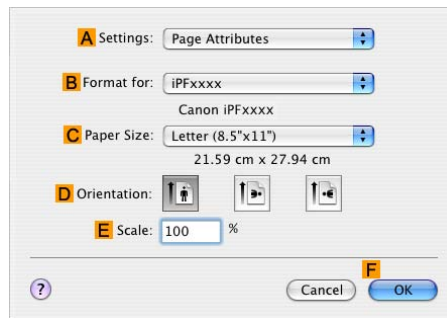

2. Select the printer in the **B Format for** list.

3. In the **C Paper Size** list, click the size of the original. In this case, click **ISO A3**.

4. Click **F OK** to close the dialog box.

5. Choose **Print** in the application menu.

6. Access the **Main** pane.

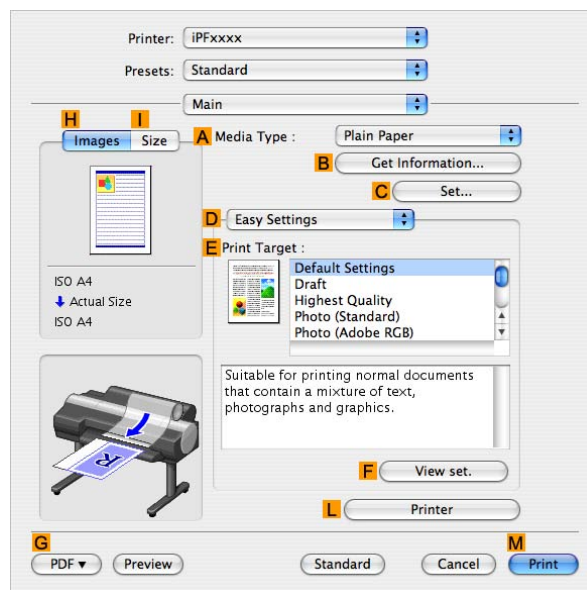

7. In the **A Media Type** list, select the type of paper that is loaded. In this case, click Plain Paper.

8. After confirming that **D Easy Settings** is selected, click **CAD (Line Drawing)** in the **E Print Target** list.



Note

- You can check the settings values selected in the **E Print Target** list by clicking **F View set..**

9. Access the **Page Setup** pane.

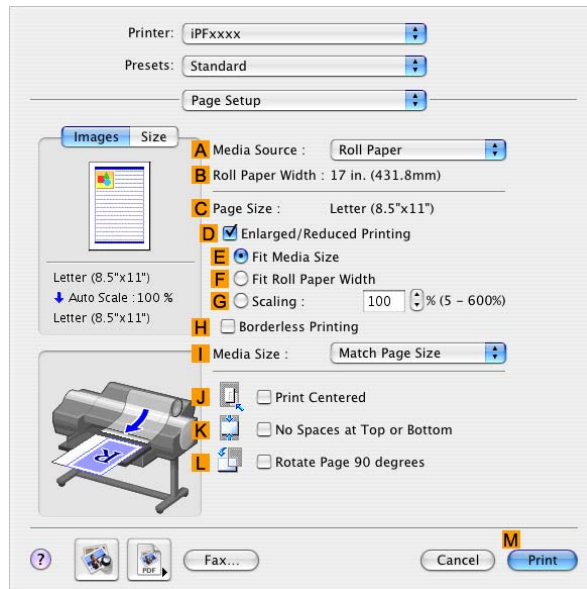

10. Click **Roll Paper** in the **A Media Source** list.

11. Make sure the width of the loaded roll is displayed in the **B Roll Paper Width** list-in this case, **ISO A2/A3 (420.0mm)**.



Note

- If the width of the loaded roll is not displayed in **B Roll Paper Width**, click **L Printer Information** on the **Main** pane and update the printer information.

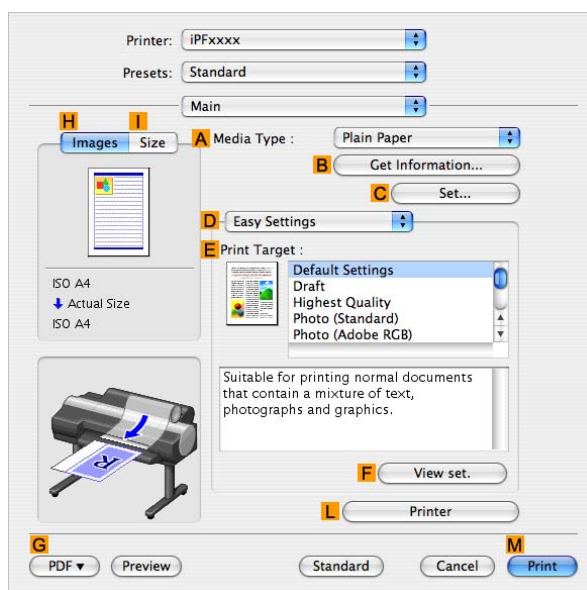

- 12.** Make sure **C Page Size** on the **Page Setup** pane shows the original size as specified in **C Paper Size** in the **Page Attribute** dialog box—in this case, **ISO A3**.

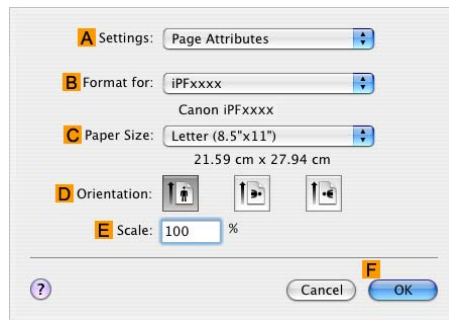

- 13.** Specify additional printing conditions.

For details on available printing conditions, see “Printer Driver Settings (Mac OS X)”. (→P.492)

- 14.** Confirm the print settings, and then click **M Print** to start printing.



Note

- For tips on confirming print settings, see “Confirming Print Settings (Mac OS X)”. (→P.493)

Printing Line Drawings and Text (Mac OS 9)

This topic describes how to print line drawings based on the following example.

- Document: CAD drawing
- Page Size: A3 (297.0×420.0 mm [11.7 × 16.5 in])
- Paper: Sheets (**Manual**)
- Paper type: Plain Paper
- Paper size: A3 (297.0×420.0 mm [11.7 × 16.5 in])

1. Select the printer in **Chooser**.
2. Choose **Page Setup** in the application menu to display the **Page Attribute** dialog box.

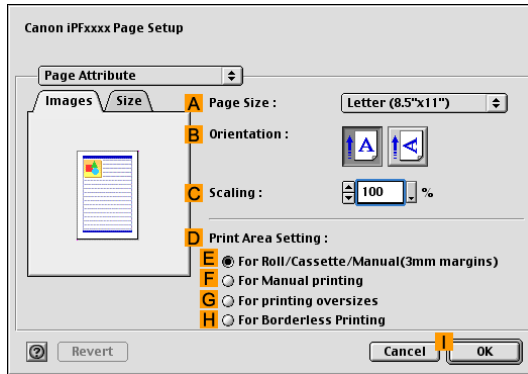

3. In the **A Page Size** list, click the size of the original. In this case, click **ISO A4**.
4. Click **I OK** to close the dialog box.
5. Choose **Print** in the application menu.
6. Make sure the **Main** pane is displayed.

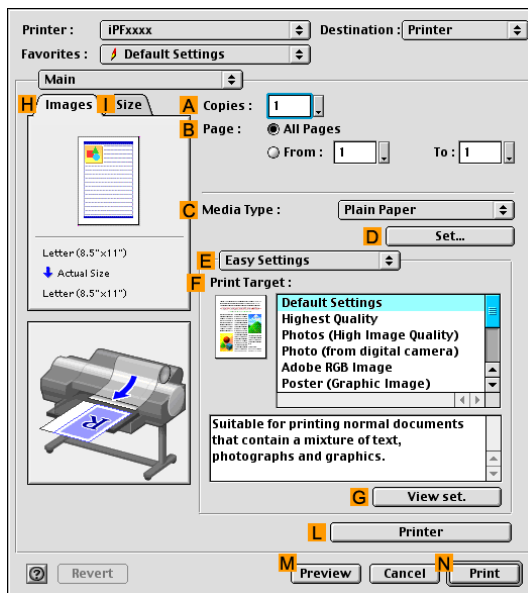

7. In the **C Media Type** list, select the type of paper that is loaded. In this case, click Plain Paper.

8. After confirming that **E Easy Settings** is selected, click **CAD (Line Drawing)** in the **F Print Target** list.



Note

- You can check the settings values selected in the **F Print Target** list by clicking **G View set**.

9. Access the **Finishing** pane.

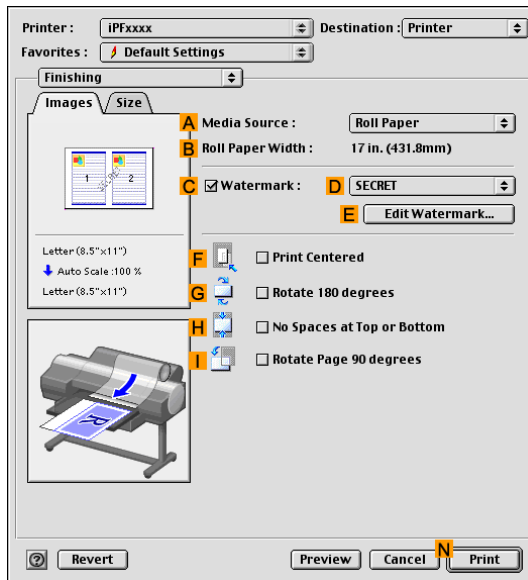

10. Click **Manual** in the **A Media Source** list.

11. Specify additional printing conditions.

For details on available printing conditions, see “Printer Driver Settings (Mac OS 9)”. (→P.517)

12. Confirm the print settings, and then click **N Print** to start printing.



Note

- For tips on confirming print settings, see “Confirming Print Settings (Mac OS 9)”. (→P.518)

Printing Office Documents (Windows)

This topic describes how to print office documents based on the following example.

- Document: Office document created using word-processing software or spreadsheet programs
- Page size: A4 (210.0×297.0 mm)/Letter (8.3 × 11.7 in)
- Paper: Sheets
- Paper type: Plain Paper
- Paper size: A4 (210.0×297.0 mm)/Letter (8.3 × 11.7 in)

1. Choose **Print** in the application menu.
2. Select the printer in the dialog box, and then display the printer driver dialog box. (→P.473)
3. Make sure the **Main** sheet is displayed.

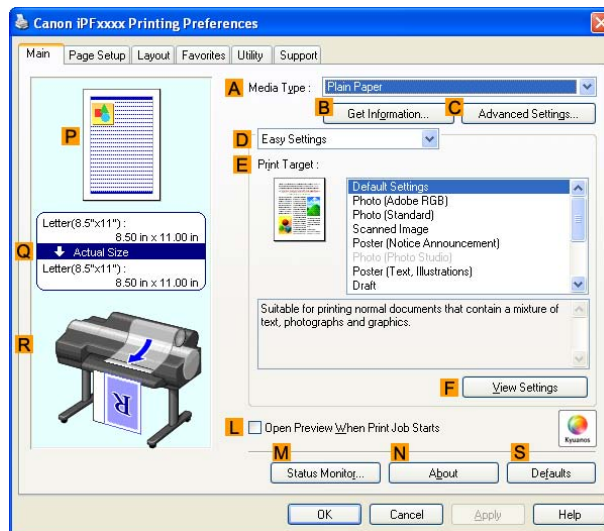

4. In the **A Media Type** list, select the type of paper that is loaded. In this case, click Plain Paper.
5. After confirming that **D Easy Settings** is selected, click **Office Document** in the **E Print Target** list.



Note

- You can check the settings values selected in the **E Print Target** list by clicking **F View Settings**.

6. Click the **Page Setup** tab to display the **Page Setup** sheet.

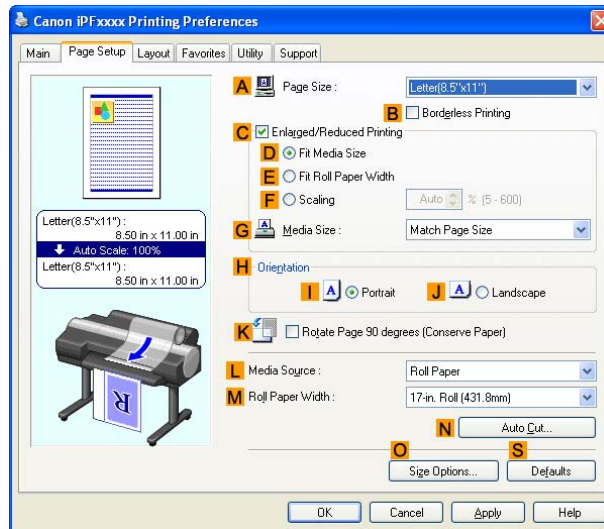

7. In the **A Page Size** list, click the size of the original as specified in the application. In this case, click **ISO A4** or **Letter (8.5"x11")**.

8. Click **Manual** in the **L Media Source** list.

9. Specify additional printing conditions.

For details on available printing conditions, see "Printer Driver Settings (Windows)". (→P.441)

10. Confirm the print settings and print as desired.



Caution

- Depending on the **Media Type** setting, some **Print Target** options may not be available.



Note

- For instructions on confirming print settings, see "Confirming Print Settings (Windows)". (→P.443)

Printing Office Documents (Mac OS X)

This topic describes how to print office documents based on the following example.

- Document: Office document created using word-processing or spreadsheet programs
- Page size: A4 (210.0×297.0 mm)/Letter (8.3 × 11.7 in)
- Paper: Sheets
- Paper type: Plain Paper
- Paper size: A4 (210.0×297.0 mm)/Letter (8.3 × 11.7 in)

1. Choose **Page Setup** in the application menu to display the **Page Attribute** dialog box.

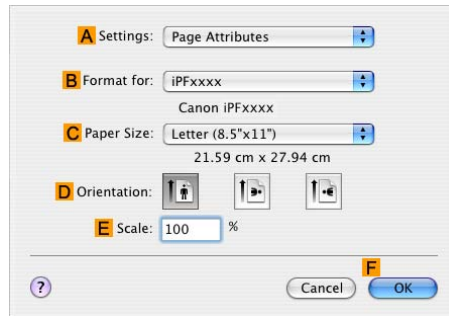

2. Select the printer in the **B Format for** list.

3. In the **C Paper Size** list, click the size of the original. In this case, click **ISO A4**.

4. Click **F OK** to close the dialog box.

5. Choose **Print** in the application menu.

6. Access the **Main** pane.

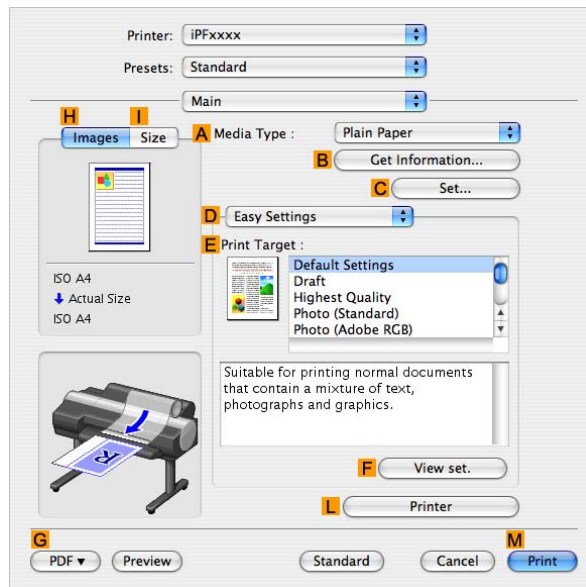

7. In the **A Media Type** list, select the type of paper that is loaded. In this case, click **Plain Paper**.

8. After confirming that **D Easy Settings** is selected, click **Office Document** in the **E Print Target** list.



Note

- You can check the settings values selected in the **E Print Target** list by clicking **F View set**.

9. Access the **Page Setup** pane.

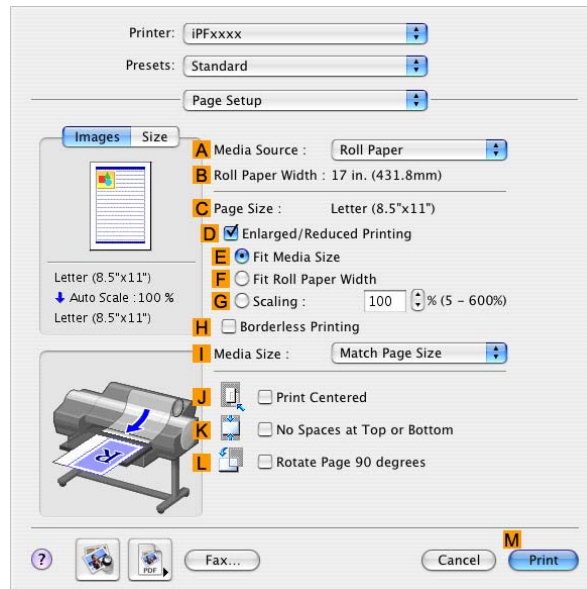

10. Click **Sheets** in the **A Media Source** list.

11. Make sure **C Page Size** shows the original size as specified in **C Paper Size** in the **Page Attribute** dialog box—in this case, **ISO A4**.

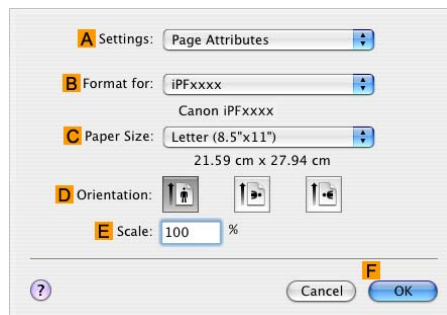

12. Specify additional printing conditions.

For details on available printing conditions, see “Printer Driver Settings (Mac OS X)”. (→P.492)

13. Confirm the print settings, and then click **M Print** to start printing.



Note

- For tips on confirming print settings, see “Confirming Print Settings (Mac OS X)”. (→P.493)

Printing Office Documents (Mac OS 9)

This topic describes how to print office documents based on the following example.

- Document: Office document created using word-processing or spreadsheet programs
- Page size: A4 (210.0×297.0 mm)/Letter (8.3 × 11.7 in)
- Paper: Sheets (**Manual**)
- Paper type: Plain Paper
- Paper size: A4 (210.0×297.0 mm)/Letter (8.3 × 11.7 in)

1. Select the printer in **Chooser**.
2. Choose **Page Setup** in the application menu to display the **Page Attribute** dialog box.

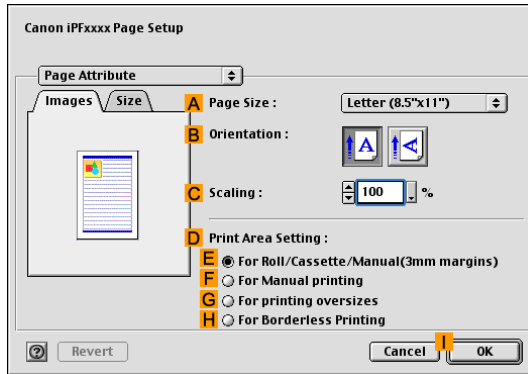

3. In the **A Page Size** list, click the size of the original. In this case, click **ISO A4**.
4. Click **I OK** to close the dialog box.
5. Choose **Print** in the application menu.
6. Make sure the **Main** pane is displayed.

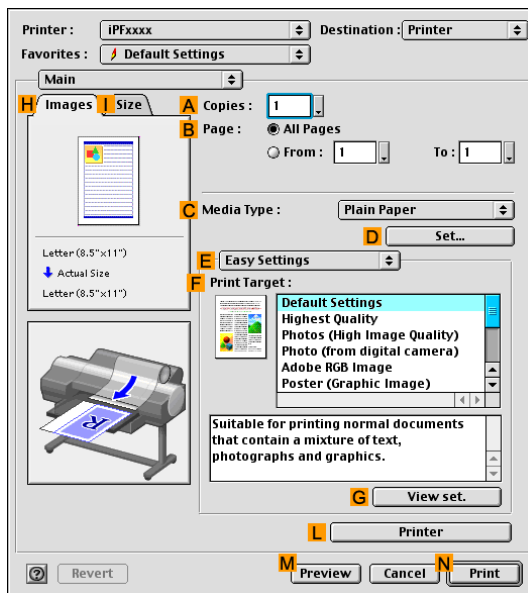

7. In the **C Media Type** list, select the type of paper that is loaded. In this case, click Plain Paper.

8. After confirming that **E Easy Settings** is selected, click **Office Document** in the **F Print Target** list.



Note

- You can check the settings values selected in the **F Print Target** list by clicking **G View set**.

9. Access the **Finishing** pane.

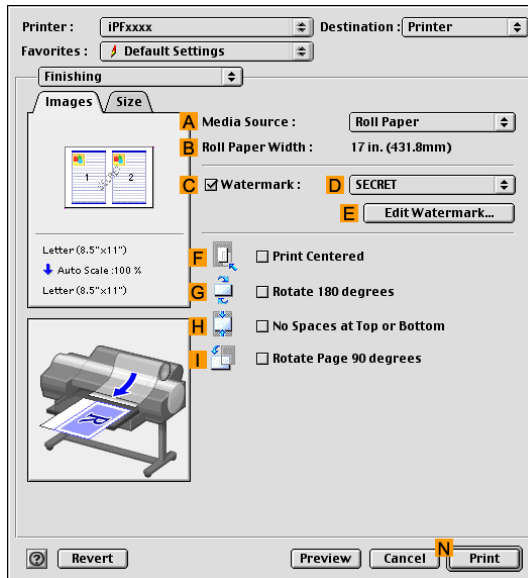

10. Click **Manual** in the **A Media Source** list.

11. Specify additional printing conditions.

For details on available printing conditions, see “Printer Driver Settings (Mac OS 9)”. (→P.517)

12. Confirm the print settings, and then click **N Print** to start printing.



Note

- For tips on confirming print settings, see “Confirming Print Settings (Mac OS 9)”. (→P.518)

Printing Photos and Images (Windows)

This topic describes how to print photos based on the following example.

- Document: Photo image from a digital camera
- Page size: 10×12 inches (254.0×304.8 mm)
- Paper: Roll
- Paper type: Glossy Photo Paper
- Roll paper width: 10 inches (254.0 mm)

1. Choose **Print** in the application menu.
2. Select the printer in the dialog box, and then display the printer driver dialog box. (→P.473)
3. Make sure the **Main** sheet is displayed.

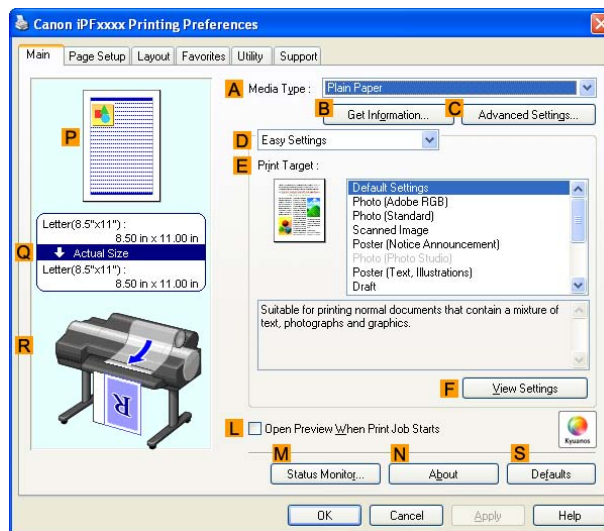

4. In the **A Media Type** list, select the type of paper that is loaded. In this case, click Glossy Photo Paper.

In the **A Media Type**, choose the type of paper used for printing, such as Glossy Paper, Coated Paper, and so on. Make sure the paper you select is loaded in the printer.



Note

- The paper type setting in the printer driver and related software (as well as on the Control Panel) is updated when you install the Media Configuration Tool from the User Software CD-ROM or if you change paper information by using the Media Configuration Tool. (See the Media Configuration Tool Guide (Windows) or Media Configuration Tool Guide (Macintosh).)

5. After confirming that **D Easy Settings** is selected, click **Photo (Standard)** or **Photo (Photo Studio)** in the **E Print Target** list.



Note

- For information on settings optimized for printing photos and images, see “Printing Photos and Images (Windows, Mac OS X)”. (→P.177)
- You can check the settings values selected in the **E Print Target** list by clicking **F View Settings**.

6. Click the **Page Setup** tab to display the **Page Setup** sheet.

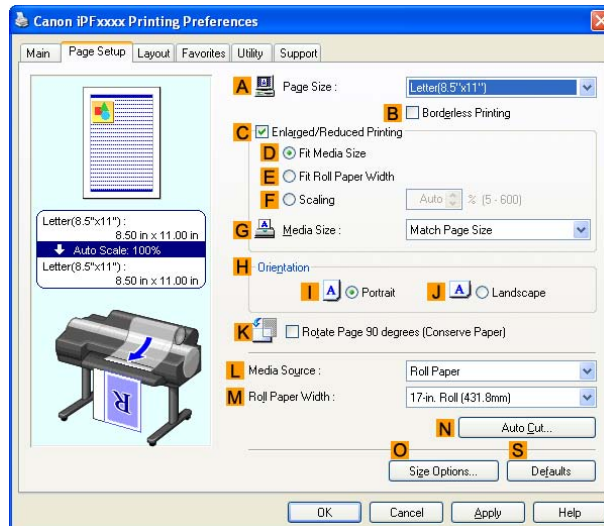

7. In the **A Page Size** list, click the size of the original as specified in the application. In this case, click **10"x12"**.
8. Click **Roll Paper** in the **L Media Source** list.
9. Select the width of the loaded roll in the **M Roll Paper Width** list. In this case, click **10-in. Roll (254.0mm)**, and then click **OK**.
10. Specify additional printing conditions.
For details on available printing conditions, see "Printer Driver Settings (Windows)". (→P.441)
11. Confirm the print settings and print as desired.



Note

- For instructions on confirming print settings, see "Confirming Print Settings (Windows)". (→P.443)

Printing Photos and Images (Mac OS X)

This topic describes how to print photos based on the following example.

- Document: Photo image from a digital camera
- Page Size: 10×12 inches (254.0×304.8 mm)
- Paper: Roll
- Paper Type: Glossy Photo Paper
- Roll paper Width: 10 inches (254 mm)

1. Choose **Page Setup** in the application menu to display the **Page Attribute** dialog box.

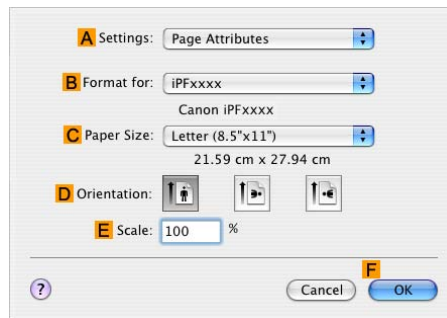

2. Select the printer in the **B Format for** list.

3. In the **C Paper Size** list, click the size of the original. In this case, click **10"×12"**.

4. Click **F OK** to close the dialog box.

5. Choose **Print** in the application menu.

6. Access the **Main** pane.

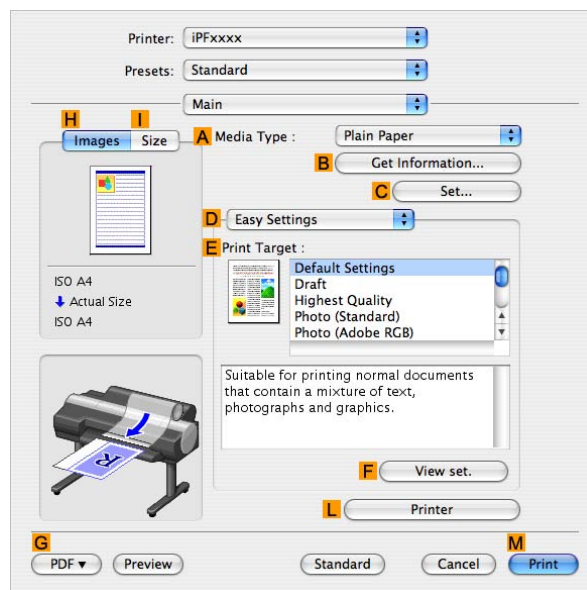

7. In the **A Media Type** list, select the type of paper that is loaded. In this case, click **Glossy Photo Paper**.

Make sure the paper you select is loaded in the printer.



Note

- The paper type setting in the printer driver and related software (as well as on the Control Panel) is updated when you install the Media Configuration Tool from the User Software CD-ROM or if you change paper information by using the Media Configuration Tool. See the Media Configuration Tool Guide (Windows) or Media Configuration Tool Guide (Macintosh).

- After confirming that **D Easy Settings** is selected, click **Photo (Standard)** or **Photo (Photo Studio)** in the **E Print Target** list.



Note

- For information on settings optimized for printing photos and images, see “Printing Photos and Images (Windows, Mac OS X)”. (→P.177)
- You can check the settings values selected in the **E Print Target** list by clicking **F View set**.

- Access the **Page Setup** pane.

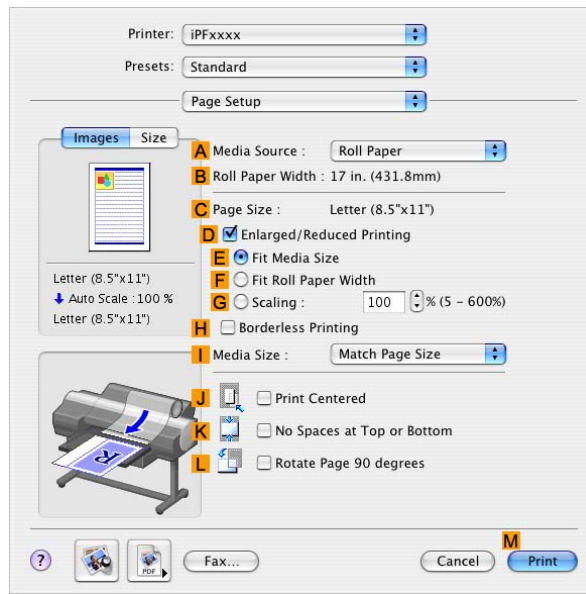

- Click **Roll Paper** in the **A Media Source** list.

- Make sure the width of the loaded roll is displayed in the **B Roll Paper Width** list in this case, **10 in. (254.0mm)**.



Note

- If the width of the loaded roll is not displayed in **B Roll Paper Width**, click **L Printer Information** on the **Main** pane and update the printer information.

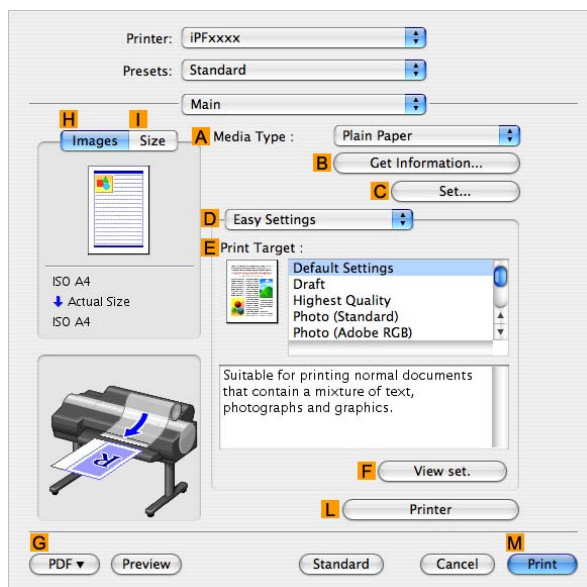

12. Make sure **C Page Size** on the **Page Setup** pane shows the original size as specified in **C Paper Size** in the **Page Attribute** dialog box—in this case, **10"x12"**.

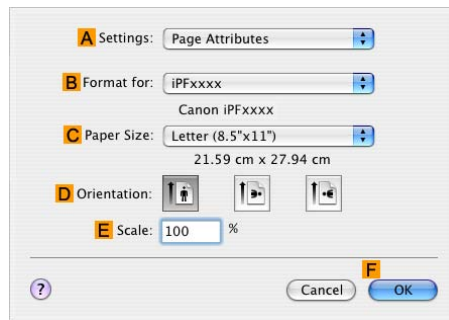

13. Specify additional printing conditions.

For details on available printing conditions, see “Printer Driver Settings (Mac OS X)”. (→P.492)

14. Confirm the print settings, and then click **M Print** to start printing.



Note

- For tips on confirming print settings, see “Confirming Print Settings (Mac OS X)”. (→P.493)

Printing Photos and Images (Mac OS 9)

This topic describes how to print photos based on the following example.

- Document: Photo image from a digital camera
- Page size: 10×12 inches (254.0×304.8 mm)
- Paper: Roll
- Paper type: Glossy Photo Paper
- Roll paper width: 10 inches (254.0mm)

1. Select the printer in **Chooser**.
2. Choose **Page Setup** from the application menu to display the **Page Attribute** dialog box.

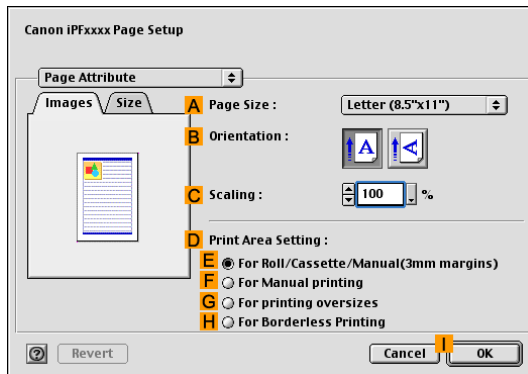

3. In the **A Page Size** list, click the size of the original. In this case, click **10"x12"**.
4. Click **I OK** to close the dialog box.
5. Choose **Print** in the application menu.
6. Make sure the **Main** pane is displayed.

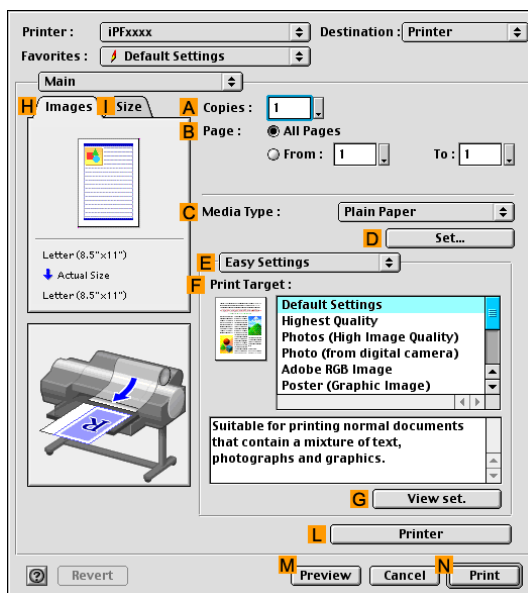

7. In the **C Media Type** list, select the type of paper that is loaded. In this case, click Glossy Photo Paper.

In the **C Media Type** setting, choose the type of paper for printing, such as Glossy Paper, Coated Paper, and so on. Make sure the paper you select is loaded in the printer.



Note

- The paper type setting in the printer driver and related software (as well as on the Control Panel) is updated when you install the Media Configuration Tool from the User Software CD-ROM or if you change paper information by using the Media Configuration Tool. See the Media Configuration Tool Guide (Windows) or Media Configuration Tool Guide (Macintosh).

8. After confirming that **E Easy Settings** is selected, click **Photo (from digital camera)** in the **F Print Target** list.



Note

- You can check the settings values selected in the **F Print Target** list by clicking **G View set**.

9. Access the **Finishing** pane.

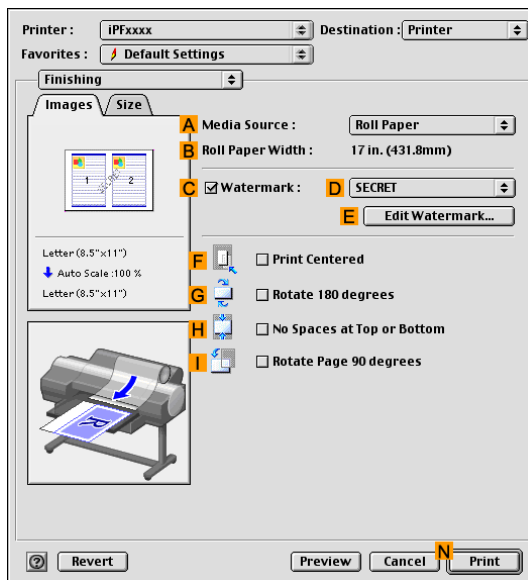

10. Click **Roll Paper** in the **A Media Source** list.

11. Make sure the width of the loaded roll is displayed in the **B Roll Paper Width** list—in this case, **10 in. (254.0mm)**.



Note

- If the width of the loaded roll is not displayed in **B Roll Paper Width**, click **L Printer** on the **Main** pane and update the printer information.

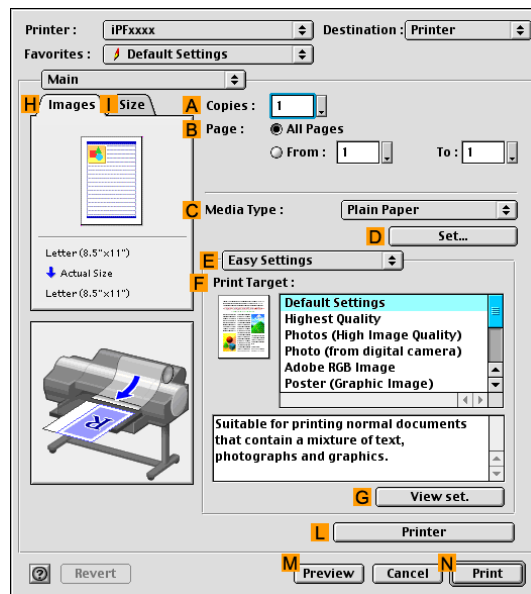

12. Specify additional printing conditions.

For details on available printing conditions, see “Printer Driver Settings (Mac OS 9)”. (→P.517)

13. Confirm the print settings, and then click **N Print** to start printing.



Note

- For tips on confirming print settings, see “Confirming Print Settings (Mac OS 9)”. (→P.518)

Printing Photos in Monochrome (Windows)

This topic describes how to print photos in monochrome based on the following example.

- Original: Photo image from a digital camera
- Page size: 10×12 inches
- Paper: Roll
- Paper type: Glossy Photo Paper
- Roll paper width: 10 inches (254.0 mm)

1. Choose **Print** in the application menu.
2. Select the printer in the dialog box, and then display the printer driver dialog box. (→P.473)
3. Make sure the **Main** sheet is displayed.

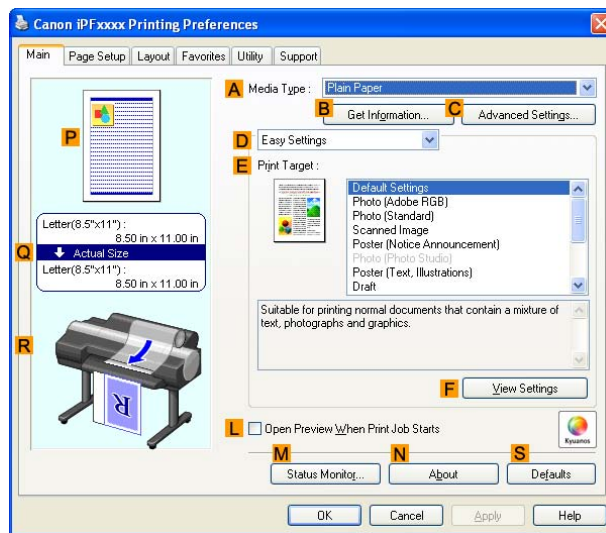

4. In the **A Media Type** list, select the type of paper that is loaded. In this case, click Glossy Photo Paper.

In the **A Media Type** setting, choose the type of paper for printing, such as Glossy Paper, Coated Paper, and so on. Make sure the paper you select is loaded in the printer.



Note

- The paper type setting in the printer driver and related software (as well as on the Control Panel) is updated when you install the Media Configuration Tool from the User Software CD-ROM or if you change paper information by using the Media Configuration Tool. (See the Media Configuration Tool Guide (Windows) or Media Configuration Tool Guide (Macintosh).)

- After confirming that **D Easy Settings** is selected, click **Photo (Monochrome)** in the **E Print Target** list.



Caution

- Photo (Monochrome)** may not be available for all types of paper.



Note

- You can check the settings values selected in the **E Print Target** list by clicking **F View Settings**.

- Click the **Page Setup** tab to display the **Page Setup** sheet.

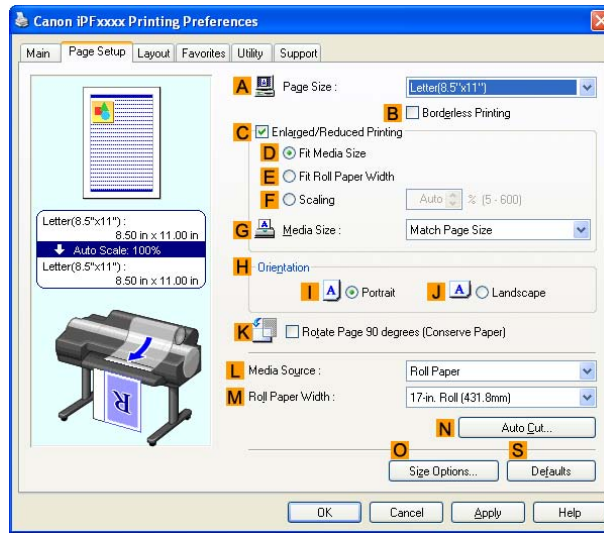

- In the **A Page Size** list, click the size of the original as specified in the application. In this case, click **10"x12"**.
- Click **Roll Paper** in the **L Media Source** list.
- Select the width of the loaded roll in the **M Roll Paper Width** list. In this case, click **10-in. Roll (254.0mm)**, and then click **OK**.
- Specify additional printing conditions.
For details on available printing conditions, see "Printer Driver Settings (Windows)". (→P.441)
- Confirm the print settings and print as desired.



Note

- For tips on confirming print settings, see "Confirming Print Settings (Windows)". (→P.443)

Printing Photos in Monochrome (Mac OS X)

This topic describes how to print photos in monochrome based on the following example.

- Original: Photo image from a digital camera
- Page size: 10×12 inches
- Paper: Roll
- Paper type: Glossy Photo Paper
- Roll paper width: 10 inches (254.0 mm)

1. Choose **Page Setup** from the application menu to display the **Page Attribute** dialog box.

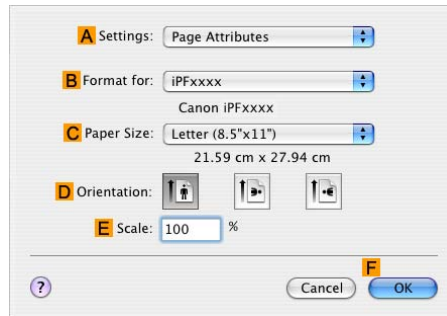

2. Select the print target in the **B Format for** list.

3. In the **C Paper Size** list, click the size of the original. In this case, click **10"x12"**.

4. Click **F OK** to close the dialog box.

5. In the source application menu, choose **Print**.

6. Access the **Main** pane.

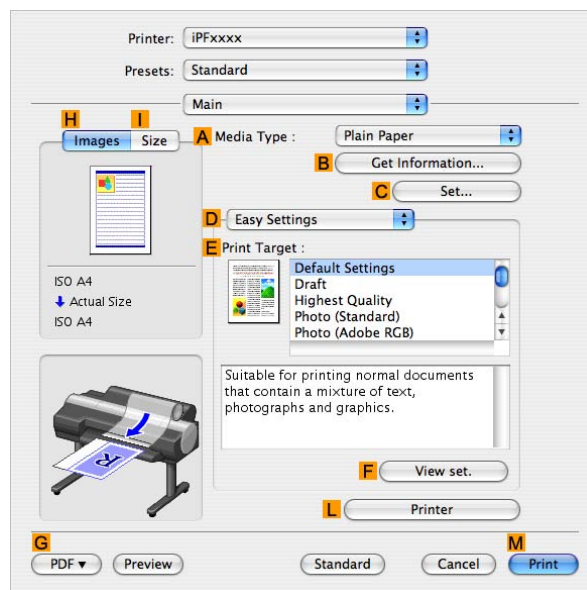

7. In the **A Media Type** list, select the type of paper that is loaded. In this case, click Glossy Photo Paper.

In the **A Media Type** setting, choose the type of paper for printing, such as Glossy Paper, Coated Paper, and so on. Make sure the paper you select is loaded in the printer.



Note

- The paper type setting in the printer driver and related software (as well as on the Control Panel) is updated when you install the Media Configuration Tool from the User Software CD-ROM or if you change paper information by using the Media Configuration Tool. (See the Media Configuration Tool Guide (Windows) or Media Configuration Tool Guide (Macintosh).)

8. After confirming that **D Easy Settings** is selected, click **Photo (Monochrome)** in the **E Print Target** list.



Caution

- **Photo (Monochrome)** may not be available for all types of paper.



Note

- You can check the settings values selected in the **E Print Target** list by clicking **F View set**.

9. Access the **Page Setup** pane.

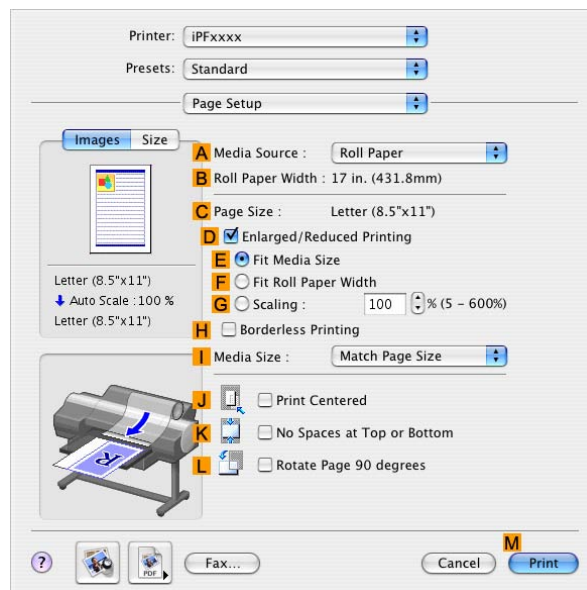

10. Click **Roll Paper** in the **A Media Source** list.

11. Make sure the width of the loaded roll is displayed in the **B Roll Paper Width** list-in this case, **10 in. (254.0mm)**.



Note

- If the width of the roll loaded in the printer is not shown in **B Roll Paper Width**, click **L Printer Information** on the **Main** pane to update the printer information.

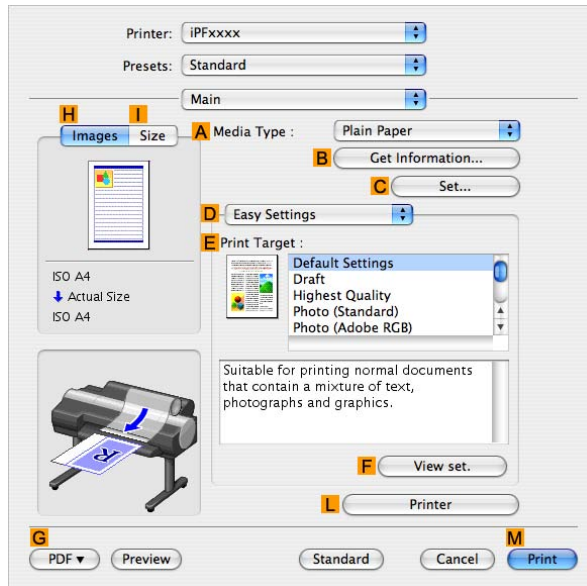

12. Make sure **C Page Size** on the **Page Setup** pane shows the original size as specified in **C Paper Size** in the **Page Attribute** dialog box-in this case, **10"x12"**.

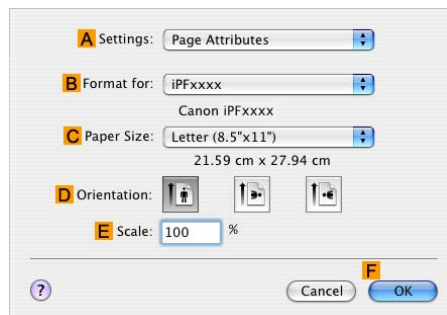

13. Specify additional printing conditions.

For details on available printing conditions, see “Printer Driver Settings (Mac OS X)”. (→P.492)

14. Confirm the print settings, and then click **M Print** to start printing.



Note

- For tips on confirming print settings, see “Confirming Print Settings (Mac OS X)”. (→P.493)

Printing Photos in Monochrome (Mac OS 9)

This topic describes how to print photos in monochrome based on the following example.

- Original: Photo image from a digital camera
- Page size: 10×12 inches
- Paper: Roll
- Paper type: Glossy Photo Paper
- Roll paper width: 10 inches (254.0 mm)

1. Select the printer in **Chooser**.
2. Choose **Page Setup** from the application menu to display the **Page Attribute** dialog box.

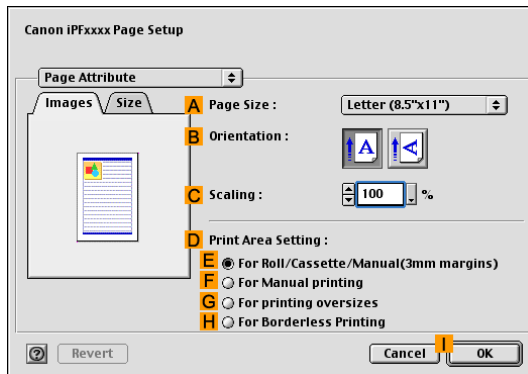

3. In the **A Page Size** list, click the size of the original. In this case, click **10"x12"**.
4. Click **I OK** to close the dialog box.
5. In the source application menu, choose **Print**.
6. Make sure the **Main** pane is displayed.

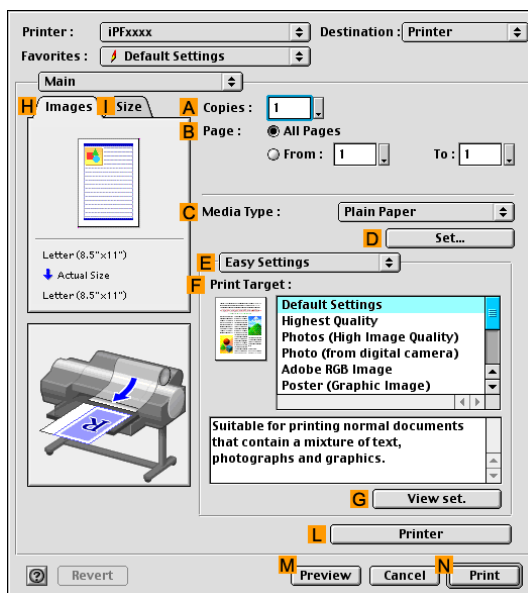

7. In the **C Media Type** list, select the type of paper that is loaded. In this case, click Glossy Photo Paper.

In the **C Media Type** setting, choose the type of paper for printing, such as Glossy Paper, Coated Paper, and so on. Make sure the paper you select is loaded in the printer.



Note

- The paper type setting in the printer driver and related software (as well as on the Control Panel) is updated when you install the Media Configuration Tool from the User Software CD-ROM or if you change paper information by using the Media Configuration Tool. (See the Media Configuration Tool Guide (Windows) or Media Configuration Tool Guide (Macintosh).)

8. After confirming that **E Easy Settings** is selected, click **Photo (Monochrome)** in the **F Print Target** list.



Caution

- **Photo (Monochrome)** may not be available for all types of paper.



Note

- You can check the settings values selected in the **F Print Target** list by clicking **G View set**.

9. Access the **Finishing** pane.

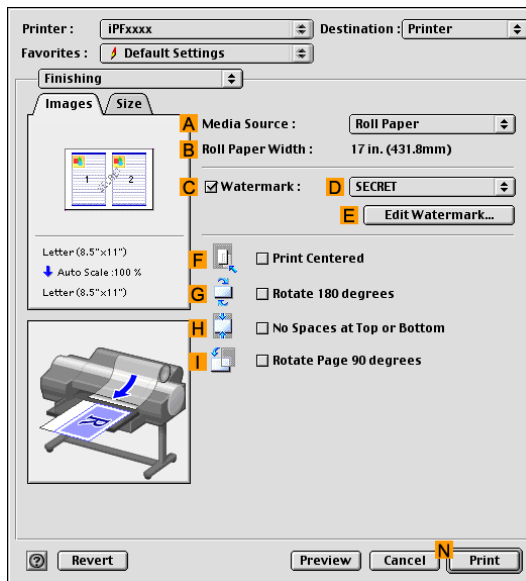

10. Click **Roll Paper** in the **A Media Source** list.

11. Make sure the width of the loaded roll is displayed in the **B Roll Paper Width** list—in this case, **10 in. (254.0mm)**.



Note

- If the width of the roll loaded in the printer is not shown in **B Roll Paper Width**, click **L Printer** on the **Main** pane to update the printer information.

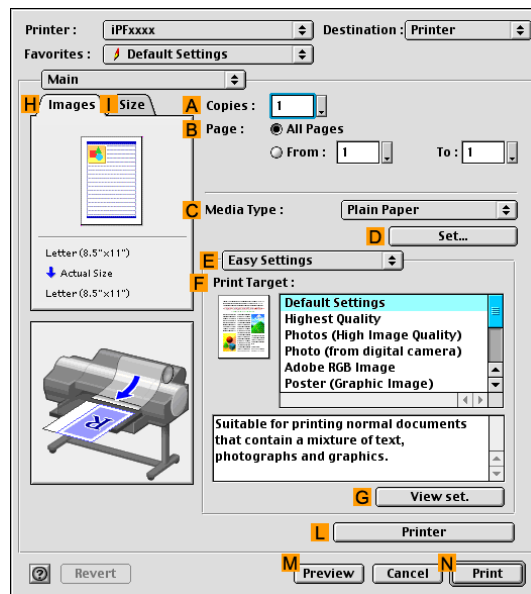

12. Specify additional printing conditions.

For details on available printing conditions, see “Printer Driver Settings (Mac OS 9)”. (→P.517)

13. Confirm the print settings, and then click **N Print** to start printing.



Note

- For tips on confirming print settings, see “Confirming Print Settings (Mac OS 9)”. (→P.518)

Printing enlargements or reductions

Resizing Originals to Match the Paper Size

You can freely adjust the size of originals by enlarging or reducing them as desired.

Enlarged/Reduced Printing

Enlarge or reduce the original in the printer driver, as desired.

Fit Media Size

Enlarge or reduce the original to match the size of the paper you are using.

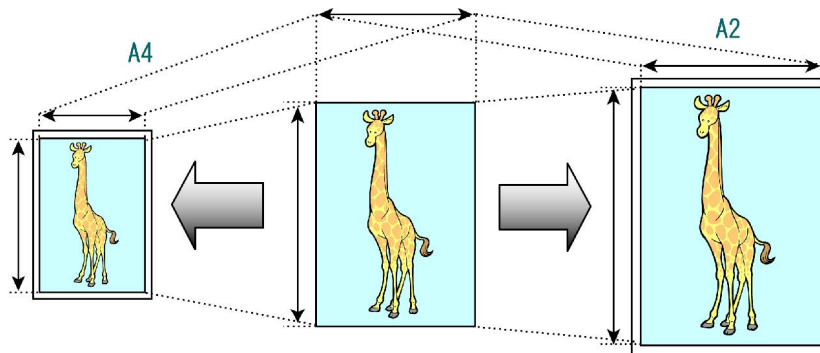

For instructions on resizing originals to match the paper size, refer to the following topics, as appropriate for your computer and operating system.

- Resizing Originals to Match the Paper Size (Windows) (→P.269)
- Resizing Originals to Match the Paper Size (Mac OS X) (→P.271)
- Resizing Originals to Match the Paper Size (Mac OS 9) (→P.274)



Note

- For better printing results when enlarging photos from a digital camera in TIFF or JPEG format, use an image-editing application software such as Adobe Photoshop to specify an image resolution of 150 dpi or more at actual size.

Resizing Originals to Fit the Roll Width

You can freely adjust the size of originals by enlarging or reducing them as desired.

Enlarged/Reduced Printing

Enlarge or reduce the original in the printer driver, as desired.

Fit Roll Paper Width

Enlarge or reduce the original as a whole to match the roll paper width, as desired.

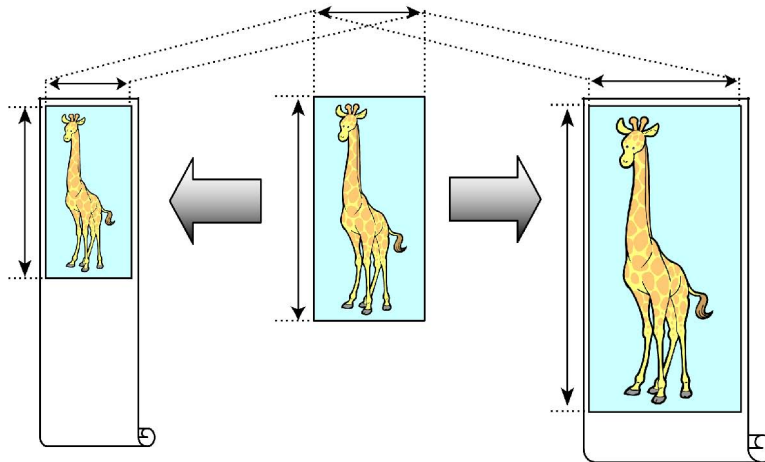

For instructions on resizing originals to match the roll paper width, refer to the following topics, as appropriate for your computer and operating system.

- Resizing Originals to Fit the Roll Width (Windows) (→P.261)
- Resizing Originals to Fit the Roll Width (Mac OS X) (→P.263)
- Resizing Originals to Fit the Roll Width (Mac OS 9) (→P.266)



Note

- For better printing results when enlarging photos from a digital camera in TIFF or JPEG format, use an image-editing application software such as Adobe Photoshop to specify an image resolution of 150 dpi or more at actual size.

Resizing Originals by Entering a Scaling Value

You can freely adjust the size of originals by enlarging or reducing them as desired.

Enlarged/Reduced Printing

Enlarge or reduce the original in the printer driver, as desired.

Scaling

Enlarge or reduce originals by a particular amount, as desired.

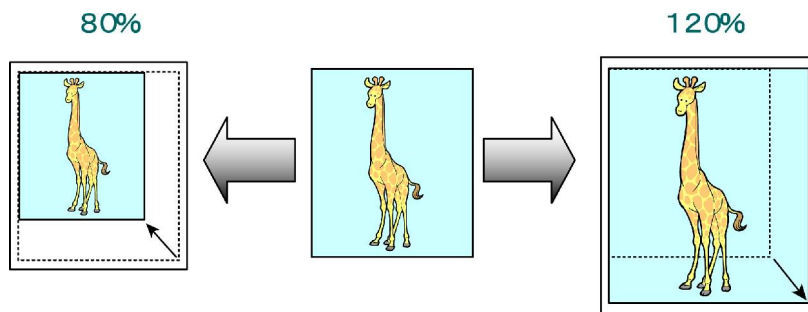

For instructions on entering a scaling value to resize originals, refer to the following topics, as appropriate for your computer and operating system.

- Resizing Originals by Entering a Scaling Value (Windows) (→P.252)
- Resizing Originals by Entering a Scaling Value (Mac OS X) (→P.254)
- Resizing Originals by Entering a Scaling Value (Mac OS 9) (→P.257)



Note

- For better printing results when enlarging photos from a digital camera in TIFF or JPEG format, use an image-editing application software such as Adobe Photoshop to specify an image resolution of 150 dpi or more at actual size.

Printing Enlargements of Scanned Originals from a Color imageRUNNER

Scanned originals from a Color imageRUNNER can be enlarged and printed automatically.

For instructions on printing enlargements of scanned originals from a Color imageRUNNER, refer to the following topic.

- [Printing Enlargements of Scanned Originals from a Color imageRUNNER \(Windows\) \(→P.248\)](#)
- [Printing Enlargements of Scanned Originals from a Color imageRUNNER \(Mac OS X\) \(→P.250\)](#)

Printing Enlargements of Scanned Originals from a Color imageRUNNER (Windows)

Scanned originals from a Color imageRUNNER can be enlarged and printed automatically.

Originals you create by scanning with a Color imageRUNNER are transferred to a "hot folder" and printed automatically after enlargement according to printing conditions you specify for that folder.

This processing sequence is called the Color imageRUNNER Enlargement Copy function.

To use Color imageRUNNER Enlargement Copy, first complete these settings in the following order.

1. Register a hot folder on your computer

Register a hot folder on your computer for storing scanned originals from the Color imageRUNNER and complete the settings for enlargement copy.

2. Complete the scanning settings on the Color imageRUNNER.

Configure the Color imageRUNNER to send scanned originals to the hot folder.

After these settings are complete, you can print enlarged copies of scanned originals from the Color imageRUNNER.

Registering a hot folder on your computer

Folders used for **Color imageRUNNER Enlargement Copy** (iR enlargement copy) are called hot folders.

Register a hot folder on your computer for storing scanned originals from the Color imageRUNNER. You can specify printing conditions (such as the image quality and paper size), based on which originals transferred to the hot folder will be printed. Follow these steps to register and modify hot folders.

1. Display the printer driver dialog box. (→P.149)
2. Click the **Utility** tab to display the **Utility** sheet.

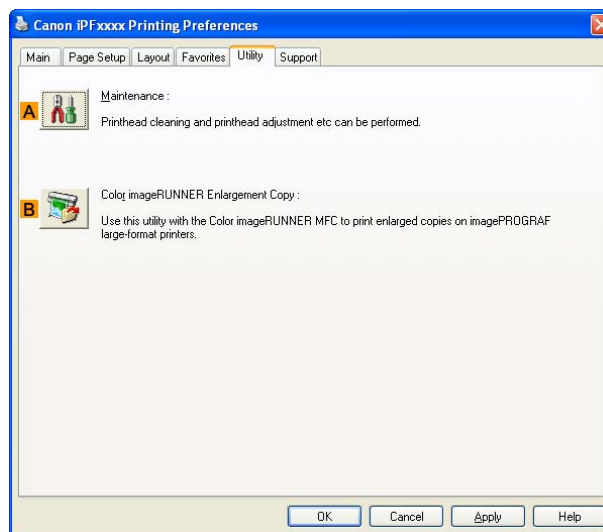

3. Click **B Color imageRUNNER Enlargement Copy** to start the Color imageRUNNER Enlargement Copy utility.
4. Use the Color imageRUNNER Enlargement Copy utility to register or modify hot folders. For instructions on registering and modifying hot folders, refer to the help file for the Color imageRUNNER Enlargement Copy utility.

Completing the scanning settings on the Color imageRUNNER.

Configure the Color imageRUNNER to send scanned originals to the hot folder. It is easy to send scanned originals to the hot folder if you assign the scanning settings and destination to a **Favorites** button on the Color imageRUNNER.

For instructions on assigning scanning settings and destinations to a **Favorites** button, refer to the setting manual, displayed by clicking **Color imageRUNNER Enlargement Copy Setup Manual** button of Color imageRUNNER Enlargement Copy utility, or refer to the Color imageRUNNER manual.

Scanning the original and print an enlargement

Follow the steps below to scan an original on the Color imageRUNNER for enlarged printing on the printer. For detailed instructions, refer to the Color imageRUNNER manual.

1. Load the original on the platen glass or document feeder of the Color imageRUNNER.
2. Press **Send** to display the screen for transmission.
3. Press **Favorites**, and then press the **Favorites** button assigned to the hot folder.
4. Press **Start** on the control panel. If you scan originals on the platen glass, after scanning all originals, press **Done** on the touch-panel display.

Scanned originals are sent to the hot folder and automatically enlarged and printed following the conditions you specified for the folder.



Note

- For details on Color imageRUNNER Enlargement Copy, refer to Color imageRUNNER Enlargement Copy Guide .

Printing Enlargements of Scanned Originals from a Color imageRUNNER (Mac OS X)

Scanned originals from a Color imageRUNNER can be enlarged and printed automatically.

Originals you create by scanning with a Color imageRUNNER are transferred to a "hot folder" and printed automatically enlarged according to printing conditions you specify for that folder.

This processing sequence is called the Color imageRUNNER Enlargement Copy function.

To use Color imageRUNNER Enlargement Copy, first complete these settings in the following order.

1. Register a hot folder on your computer.

Register a hot folder on your computer for storing scanned originals from the Color imageRUNNER and complete the settings for enlargement copy.

2. Complete the scanning settings on the Color imageRUNNER.

Configure the Color imageRUNNER to send scanned originals to the hot folder.

After these settings are complete, you can print enlarged copies of scanned originals from the Color imageRUNNER.

Registering a hot folder on your computer

Folders used for **Color imageRUNNER Enlargement Copy** (iR enlargement copy) are called hot folders.

Register a hot folder on your computer for storing scanned originals from the Color imageRUNNER. You can specify printing conditions (such as the image quality and paper size), based on which originals transferred to the hot folder will be printed. Follow these steps to register and modify hot folders.

- 1.** To display the **GARO ExtraKit** dialog box, either double-click the **GARO ExtraKit** icon after navigating to **Applications - Canon Utilities - imagePROGRAF**, or click **C Set** on the **Utility** pane.

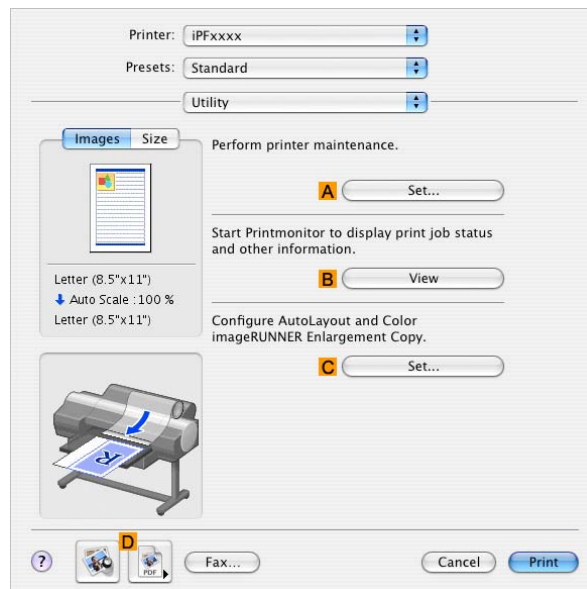

- 2.** In **Enlarged Copy Settings**, click **Add** or **Edit** and either create or modify the hot folder. For instructions on registering and modifying hot folders, refer to the help file for the **GARO ExtraKit** utility.

Completing the scanning settings on the Color imageRUNNER.

Configure the Color imageRUNNER to send scanned originals to the hot folder. It is easy to send scanned originals to the hot folder if you assign the scanning settings and destination to a **Favorites** button on the Color imageRUNNER.

For instructions on assigning scanning and sending settings to the **Favorites** button, refer to the Color imageRUNNER manual.

Scanning the original and print an enlargement

Follow the steps below to scan an original on the Color imageRUNNER for enlarged printing on the printer. For detailed instructions, refer to the Color imageRUNNER manual.

1. Load the original on the platen glass or document feeder of the Color imageRUNNER.
2. Press **Send** to display the screen for transmission.
3. Press **Favorites**, and then press the **Favorites** button assigned to the hot folder.
4. Press **Start** on the control panel. If you scan originals on the platen glass, after scanning all originals, press **Done** on the touch-panel display.

Scanned originals are sent to the hot folder and automatically enlarged and printed following the conditions you specified for the folder.



Note

- For details on Color imageRUNNER Enlargement Copy, refer to Color imageRUNNER Enlargement Copy Guide .

Resizing Originals by Entering a Scaling Value (Windows)

This topic describes how to enlarge originals before printing by entering a scaling value, based on the following example.

- Document: Any type
- Page size: A4 (210.0×297.0 mm)/Letter (8.3 × 11.7 in)
- Paper: Roll
- Paper type: Plain Paper
- Roll paper width: A2/A3 roll (420.0 mm [16.5 in])



Important

- In borderless printing, you cannot resize originals by entering a scaling value.

1. Choose **Print** in the application menu.
2. Select the printer in the dialog box, and then display the printer driver dialog box. (→P.473)
3. Make sure the **Main** sheet is displayed.

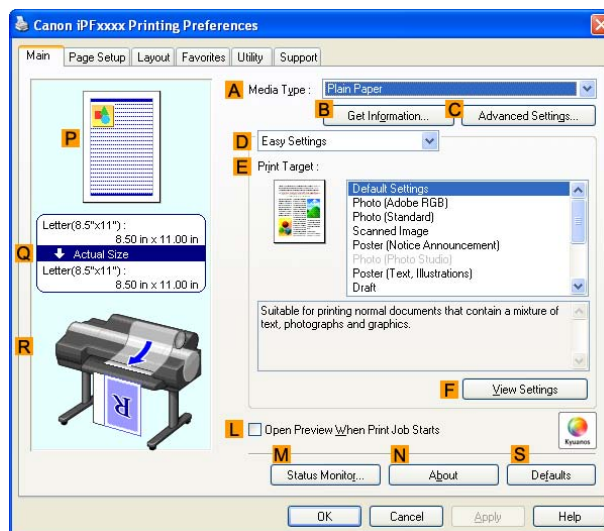

4. In the **A Media Type** list, select the type of paper that is loaded. In this case, click Plain Paper.
5. Select the print target in the **E Print Target** list.
6. Click the **Page Setup** tab to display the **Page Setup** sheet.

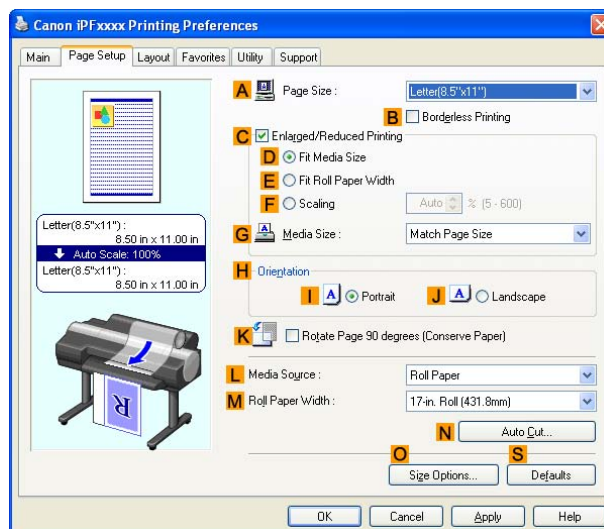

7. Click **Roll Paper** in the **L Media Source** list.
8. Select the width of the loaded roll in the **M Roll Paper Width** list-in this case, **ISO A2/A3 Roll (420.0mm)**.
9. In the **A Page Size** list, click the size of the original as specified in the application. In this case, click **ISO A4** or **Letter (8.5"x11")**.
10. Select the **C Enlarged/Reduced Printing** check box.
11. Click **ISO A4** in the **G Media Size** list.
12. Click **F Scaling** and enter "120."



Note

- You can specify enlargement that exceeds the paper size, but in this case, the portion off the edge of the paper will not be printed.
- If the original size after enlargement or reduction is smaller than the paper size, the original is printed in the upper-left corner. In this case, you can center originals by selecting **G Print Centered** on the **Layout** sheet.

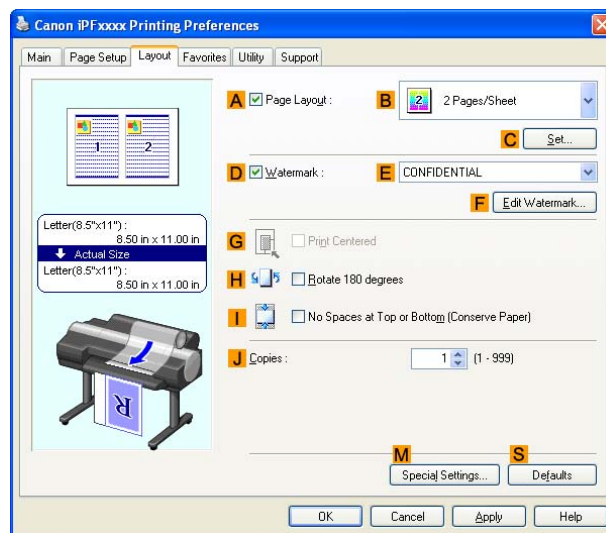

13. Confirm the print settings and print as desired.



Note

- For tips on confirming print settings, see "Confirming Print Settings (Windows)". (→P.443)

Resizing Originals by Entering a Scaling Value (Mac OS X)

This topic describes how to enlarge originals before printing by entering a scaling value, based on the following example.

- Document: Any type
- Page size: A4 (210.0×297.0 mm)/Letter (8.3 × 11.7 in)
- Paper: Roll
- Paper type: Plain Paper
- Roll paper width: A2/A3 roll (420.0 mm [16.5 in])



Important

- In borderless printing, you cannot resize originals by entering a scaling value.

1. Choose **Page Setup** in the application menu to display the **Page Attribute** dialog box.

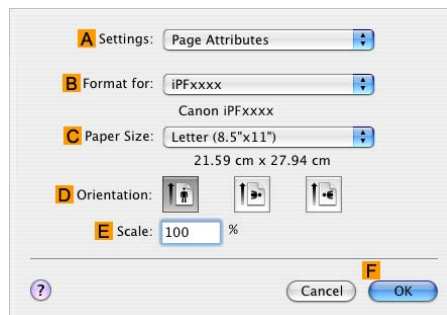

2. Select the printer in the **B Format for** list.

3. In **C Paper Size**, click the size of the original. In this case, click **ISO A4**.

4. Click **F OK** to close the dialog box.

5. Choose **Print** in the application menu.

6. Access the **Main** pane.

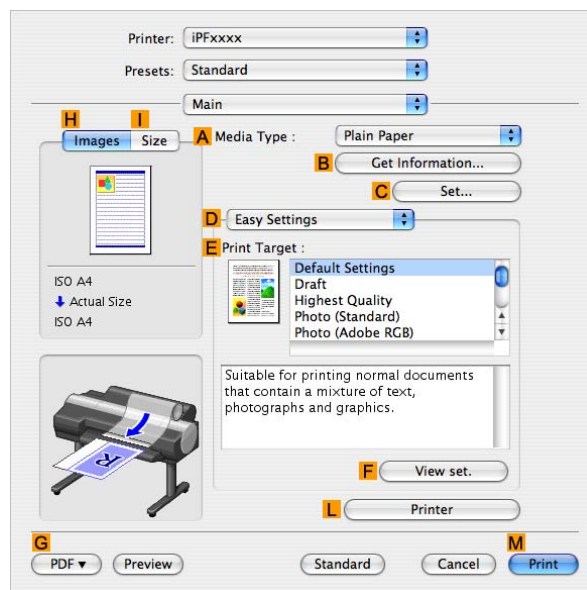

7. In the **A Media Type** list, select the type of paper that is loaded. In this case, click Plain Paper.
8. Select the print target in the **E Print Target** list.
9. Access the **Page Setup** pane.

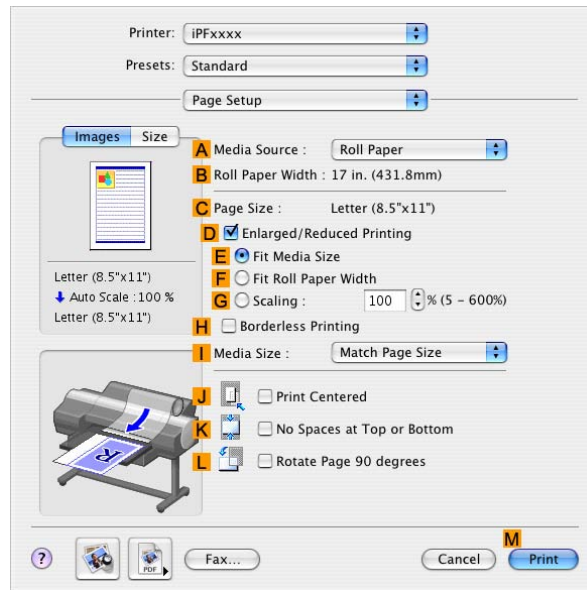

10. Click **Roll Paper** in the **A Media Source** list.
11. Make sure the width of the loaded roll is displayed in the **B Roll Paper Width** list-in this case, **ISO A2/A3 (420.0mm)**.



Note

- If the width of the loaded roll is not displayed in **B Roll Paper Width**, click **L Printer Information** on the **Main** pane and update the printer information.

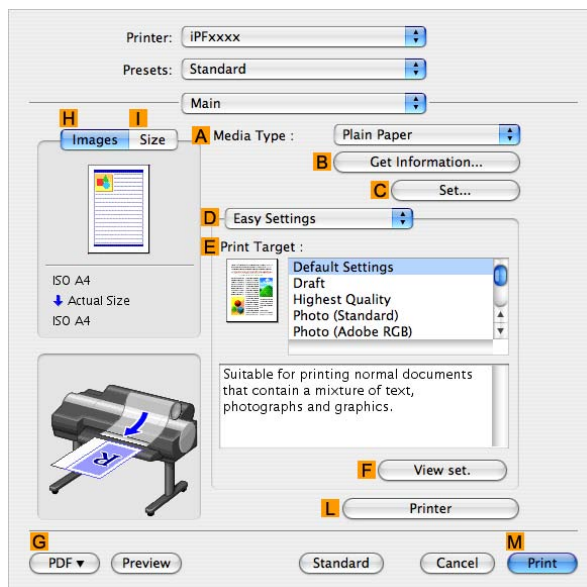

12. Make sure the **C Page Size** setting matches the original size as selected in **C Paper Size** in the **Page Attribute** dialog box—in this case, **ISO A4**.

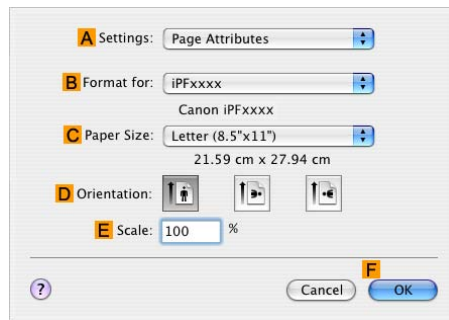

13. Select the **D Enlarged/Reduced Printing** check box.

14. Click **G Scaling** and enter “120.”



Note

- You can specify enlargement that exceeds the paper size, but in this case, the portion off the edge of the paper will not be printed.
- If the original size after enlargement or reduction is smaller than the paper size, the original is printed in the upper-left corner. In this case, you can center originals by selecting the **J Print Centered** check box.

15. Confirm the print settings, and then click **M Print** to start printing.



Note

- For tips on confirming print settings, see “Confirming Print Settings (Mac OS X)”. (→P.493)

Resizing Originals by Entering a Scaling Value (Mac OS 9)

This topic describes how to enlarge originals before printing by entering a scaling value, based on the following example.

- Document: Any type
- Page size: A4 (210.0×297.0 mm)/Letter (8.3 × 11.7 in)
- Paper: Roll
- Paper type: Plain Paper
- Roll paper width: A2/A3 roll (420.0 mm [16.5 in])



Important

- In borderless printing, you cannot resize originals by entering a scaling value.

1. Select the printer in **Chooser**.
2. Choose **Page Setup** from the application menu to display the **Page Attribute** dialog box.

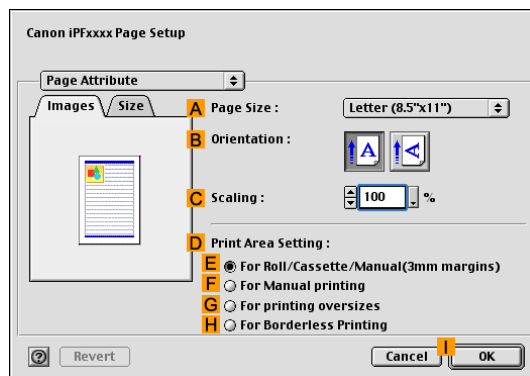

3. In **A Page Size**, click the size of the original. In this case, click **ISO A4**.
4. Click **I OK** to close the dialog box.
5. Choose **Print** in the application menu.
6. Make sure the **Main** pane is displayed.

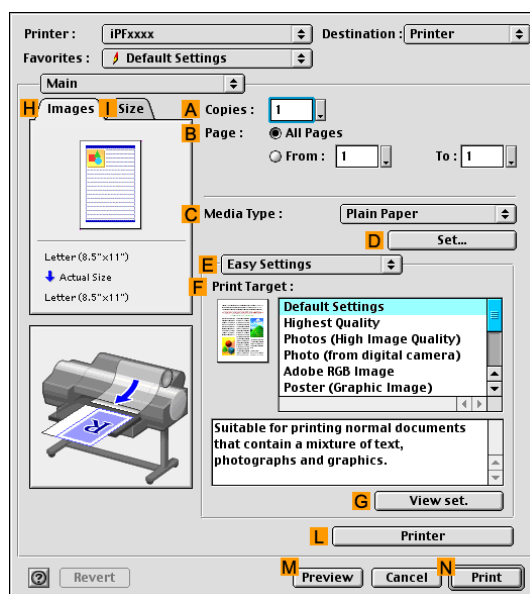

7. In the **C Media Type** list, select the type of paper that is loaded. In this case, click Plain Paper.
8. Select the print target in the **F Print Target** list.
9. Access the **Finishing** pane.

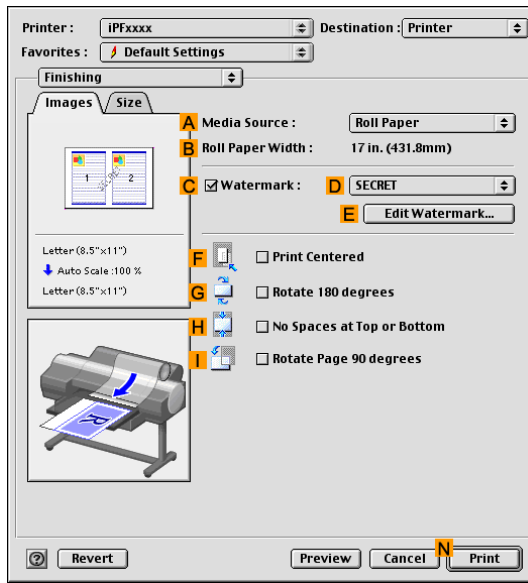

10. Click **Roll Paper** in the **A Media Source** list.
11. Make sure the width of the loaded roll is displayed in the **B Roll Paper Width** list—here, **ISO A2/A3 (420.0mm)**.



Note

- If the width of the loaded roll is not displayed in **B Roll Paper Width**, click **L Printer** on the **Main** pane and update the printer information.

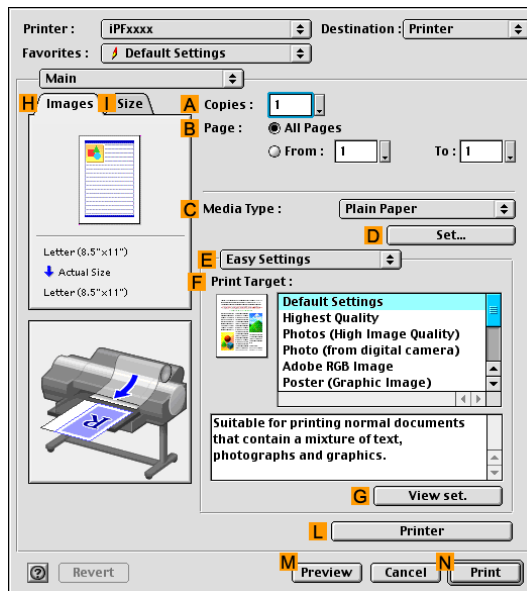

12. Access the **Page Setup** pane.

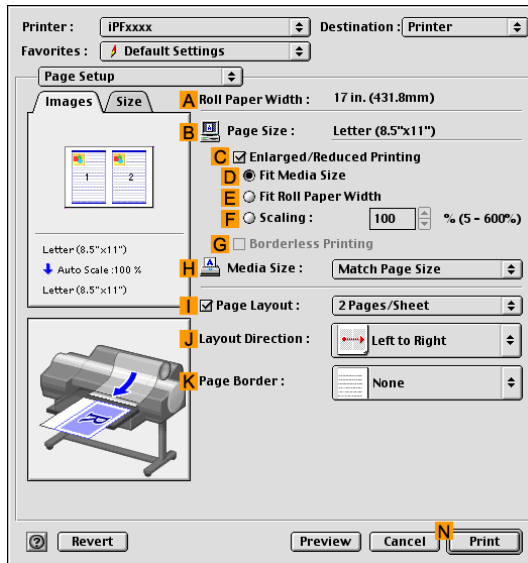

13. Make sure the **B Page Size** setting matches the original size as selected in **A Page Size** in the **Page Attribute** dialog box-in this case, **ISO A4**.

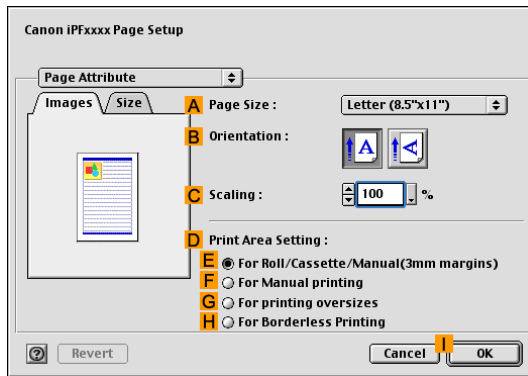

14. Select the **C Enlarged/Reduced Printing** check box.

15. Click **F** **Scaling** and enter “120.”



Note

- You can specify enlargement that exceeds the paper size, but in this case, the portion off the edge of the paper will not be printed.
- If the original size after enlargement or reduction is smaller than the paper size, the original is printed in the upper-left corner. In this case, you can center originals by selecting **F** **Print Centered** on the **Finishing** pane.

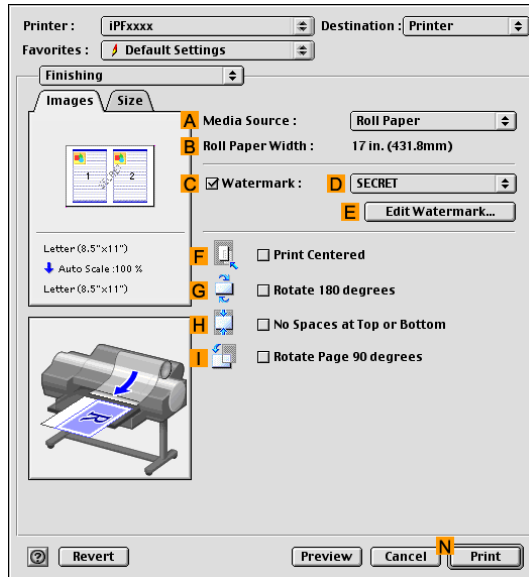

16. Confirm the print settings, and click **N** **Print** to start printing.



Note

- For tips on confirming print settings, see “Confirming Print Settings (Mac OS 9)”. (→P.518)

Resizing Originals to Fit the Roll Width (Windows)

This topic describes how to enlarge originals before printing to match the roll width, based on the following example.

- Document: Any type
- Page size: A4 (210.0×297.0 mm)/Letter (8.3 × 11.7 in)
- Paper: Roll
- Paper type: Plain Paper
- Roll paper width: 16 inches (406.4 mm)

1. Choose **Print** in the application menu.
2. Select the printer in the dialog box, and then display the printer driver dialog box. (→P.473)
3. Make sure the **Main** sheet is displayed.

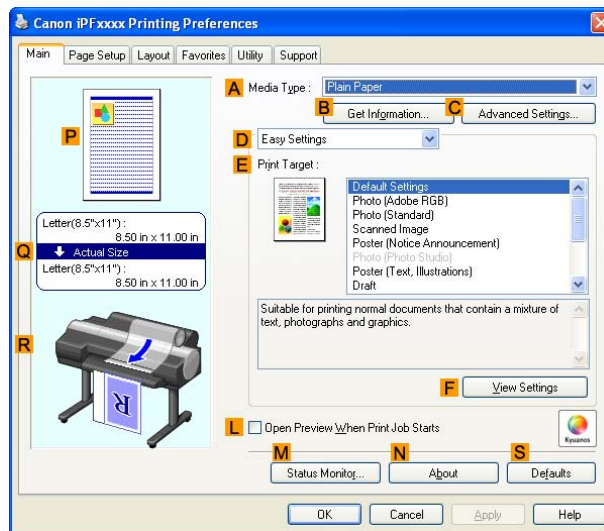

4. In the **A Media Type** list, select the type of paper that is loaded. In this case, click Plain Paper.
5. Select the printing application in the **E Print Target** list.
6. Click the **Page Setup** tab to display the **Page Setup** sheet.

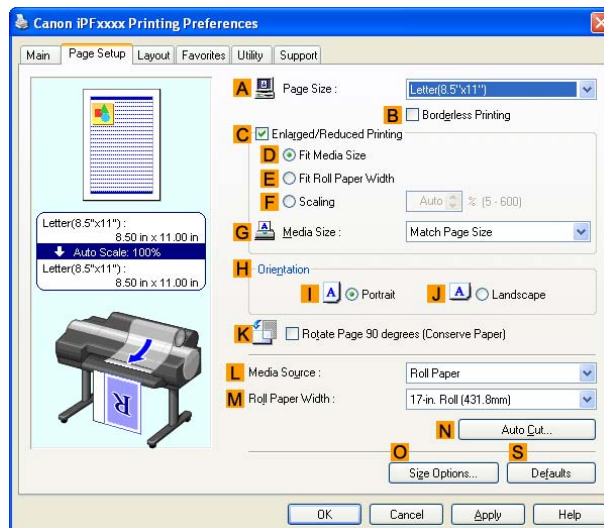

7. Click **R**oll Paper in the **L** Media Source list.
8. In the **A** Page Size list, click the size of the original as specified in the application. In this case, click **ISO A4** or **Letter (8.5"x11")**.
9. Select the **C** Enlarged/Reduced Printing check box.



Note

- If the **Enlarged/Reduced Printing** check box is not displayed on the **Page Setup** sheet, clear the **B** Borderless Printing check box.

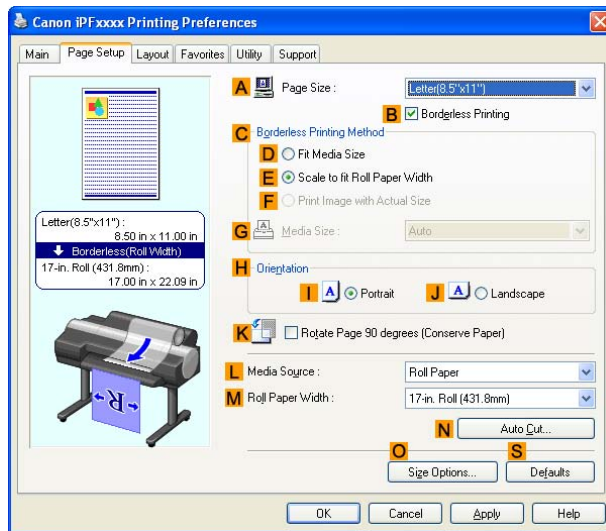

10. Click **E** Fit Roll Paper Width.



Note

- After you click **E** Fit Roll Paper Width, the **Information** dialog box is displayed. Select the width of the loaded roll in the **Roll Paper Width** list and click **OK**.
- Make sure the roll paper width you specify matches the width of the loaded roll.

11. Confirm the print settings and print as desired.



Note

- For tips on confirming print settings, see “Confirming Print Settings (Windows)”. (→P.443)

Resizing Originals to Fit the Roll Width (Mac OS X)

This topic describes how to enlarge originals before printing to match the roll width, based on the following example.

- Document: Any type
- Page size: A4 (210.0×297.0 mm)/Letter (8.3 × 11.7 in)
- Paper: Roll
- Paper type: Plain Paper
- Roll paper width: 16 inches (406.4 mm)

1. Choose **Page Setup** from the application menu to display the **Page Attribute** dialog box.

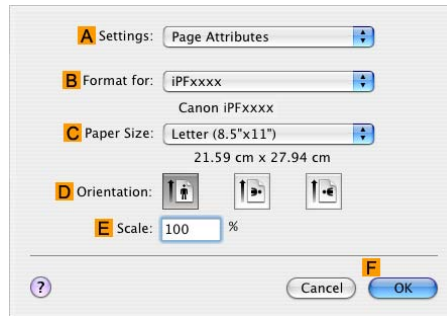

2. Select the printer in the **B Format for** list.

3. In **C Paper Size**, click the size of the original. In this case, click **ISO A4**.

4. Click **F OK** to close the dialog box.

5. Choose **Print** in the application menu.

6. Access the **Main** pane.

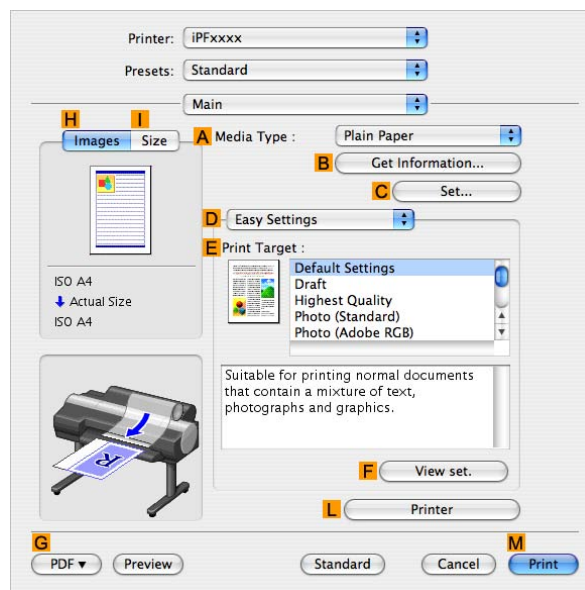

7. In the **A Media Type** list, select the type of paper that is loaded. In this case, click Plain Paper.
8. Select the print target in the **E Print Target** list.
9. Access the **Page Setup** pane.

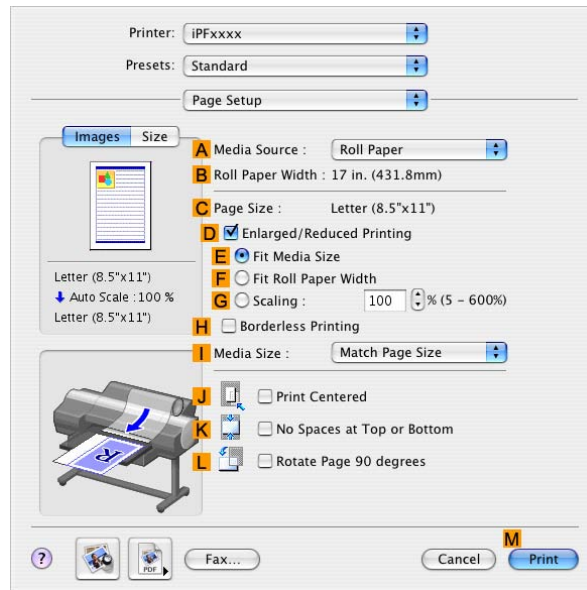

10. Click **Roll Paper** in the **A Media Source** list.
11. Make sure the width of the loaded roll is displayed in the **B Roll Paper Width** list-in this case, **16 in. (406.4mm)**.



Note

- If the width of the loaded roll is not displayed in **B Roll Paper Width**, click **L Printer Information** on the **Main** pane and update the printer information.

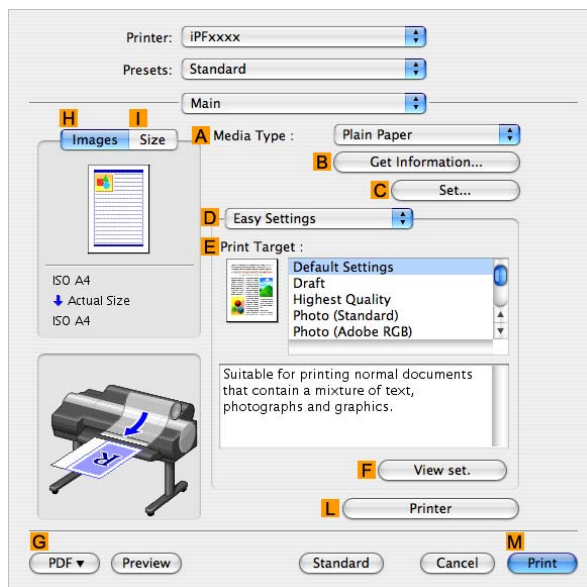

12. Make sure the **C Page Size** setting matches the original size as selected in **C Paper Size** in the **Page Attribute** dialog box-in this case, **ISO A4**.

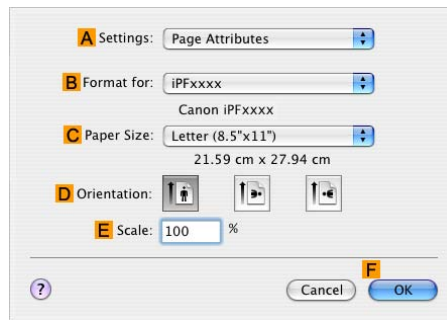

13. Select the **D Enlarged/Reduced Printing** check box.
14. Click **F Fit Roll Paper Width**.
15. Confirm the print settings, and then click **M Print** to start printing.

**Note**

- For tips on confirming print settings, see “Confirming Print Settings (Mac OS X)”. (→P.493)

Resizing Originals to Fit the Roll Width (Mac OS 9)

This topic describes how to enlarge originals before printing to match the roll paper width, based on the following example.

- Document: Any type
- Page size: A4 (210.0×297.0 mm)/Letter (8.3 × 11.7 in)
- Paper: Roll
- Paper type: Plain Paper
- Roll paper width: 16 inches (406.4 mm)

1. Select the printer in **Chooser**.
2. Choose **Page Setup** from the application menu to display the **Page Attribute** dialog box.

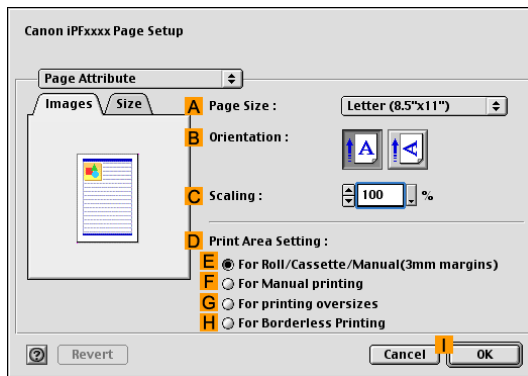

3. In **A Page Size**, click the size of the original. In this case, click **ISO A4**.
4. Click **I OK** to close the dialog box.
5. Choose **Print** in the application menu.
6. Make sure the **Main** pane is displayed.

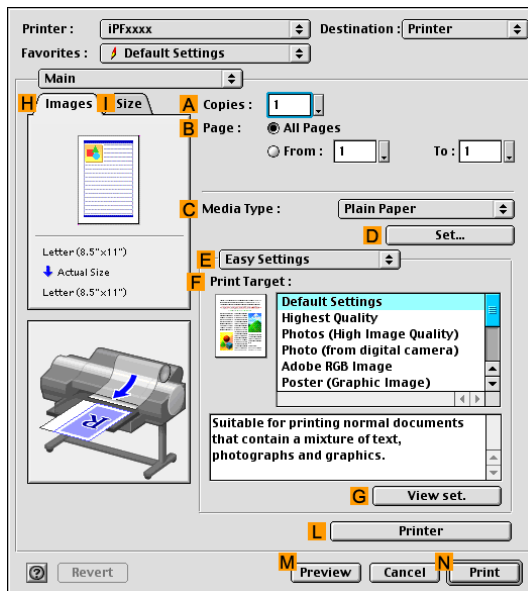

7. In the **C Media Type** list, select the type of paper that is loaded. In this case, click Plain Paper.
8. Select the print target in the **F Print Target** list.
9. Access the **Finishing** pane.

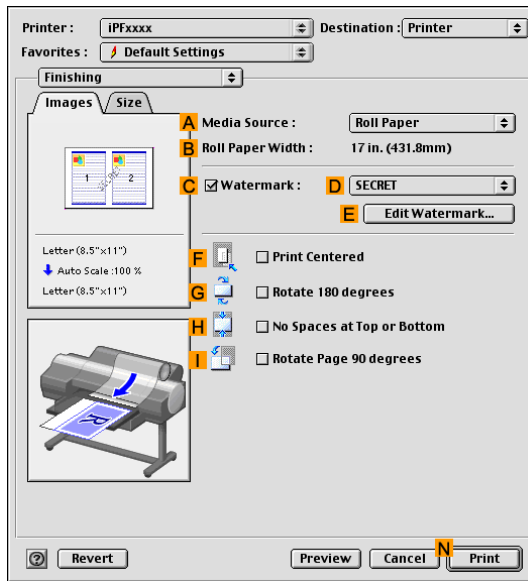

10. Click **Roll Paper** in the **A Media Source** list.
11. Make sure the width of the loaded roll is displayed in the **B Roll Paper Width** list-in this case, **16 in. (406.4mm)**.



Note

- If the width of the loaded roll is not displayed in **B Roll Paper Width**, click **L Printer** on the **Main** pane and update the printer information.

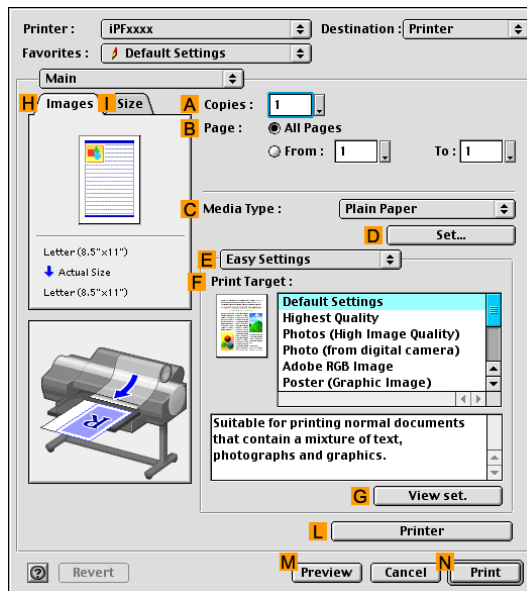

12. Access the **Page Setup** pane.

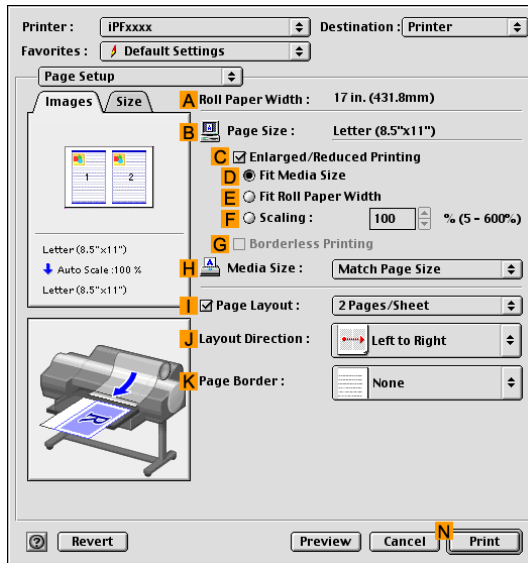

13. Make sure the **B Page Size** setting matches the original size as selected in **A Page Size** in the **Page Attribute** dialog box-in this case, **ISO A4**.

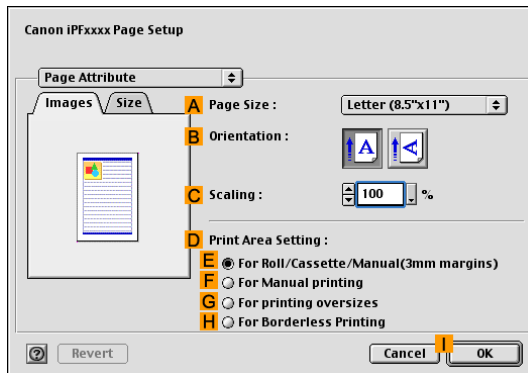

14. Select the **C Enlarged/Reduced Printing** check box.

15. Click **E Fit Roll Paper Width**.

16. Confirm the print settings, and click **N Print** to start printing.



Note

- For tips on confirming print settings, see “Confirming Print Settings (Mac OS 9)”. (→P.518)

7. Click **Roll Paper** in the **L Media Source** list.
8. Select the width of the loaded roll in the **M Roll Paper Width** list-in this case, **ISO A2/A3 Roll (420.0mm)**.
9. In the **A Page Size** list, click the size of the original as specified in the application. In this case, click **ISO A4**.
10. Select the **C Enlarged/Reduced Printing** check box.
11. Select the **D Fit Media Size** check box.
12. Click **ISO A3** in the **G Media Size** list.
13. Confirm the print settings and print as desired.



Note

- For tips on confirming print settings, see “Confirming Print Settings (Windows)”. (→P.443)

Resizing Originals to Match the Paper Size (Mac OS X)

This topic describes how to enlarge originals before printing to match the paper size, based on the following example.

- Document: Any Type
- Page size: A4 (210.0×297.0mm)/Letter (8.3 × 11.7 in)
- Paper: Roll
- Paper type: Plain Paper
- Roll paper width: A2/A3 roll (420.0 mm [16.5 in])

1. Choose **Page Setup** in the application menu to display the **Page Attribute** dialog box.

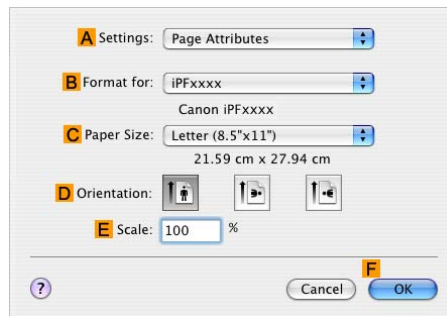

2. Select the printer in the **B Format for** list.

3. In **C Paper Size**, click the size of the original. In this case, click **ISO A4**.

4. Click **F OK** to close the dialog box.

5. Choose **Print** in the application menu.

6. Access the **Main** pane.

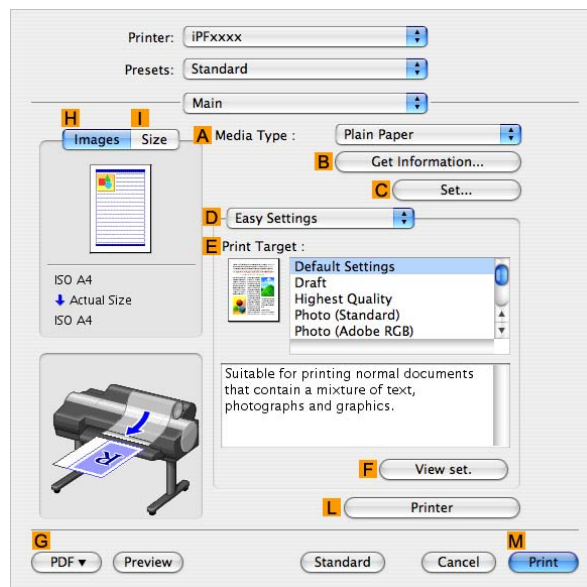

7. In the **A Media Type** list, select the type of paper that is loaded. In this case, click Plain Paper.
8. Select the printing application in the **E Print Target** list.
9. Access the **Page Setup** pane.

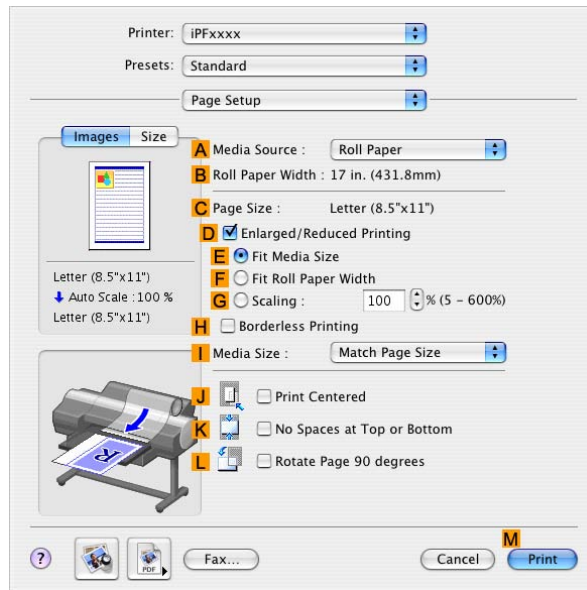

10. Click **Roll Paper** in the **A Media Source** list.
11. Make sure the width of the loaded roll is displayed in the **B Roll Paper Width** list-in this case, **ISO A2/A3 (420.0mm)**.



Note

- If the width of the loaded roll is not displayed in **B Roll Paper Width**, click **L Printer Information** on the **Main** pane and update the printer information.

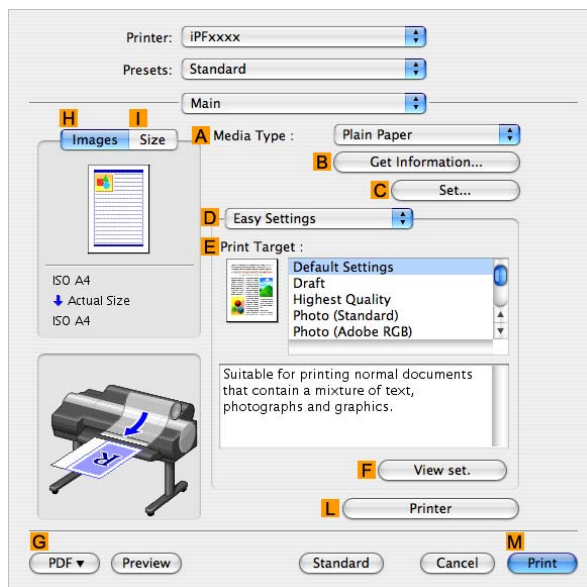

12. Make sure the **C Page Size** setting matches the original size as selected in **C Paper Size** in the **Page Attribute** dialog box-in this case, **ISO A4**.

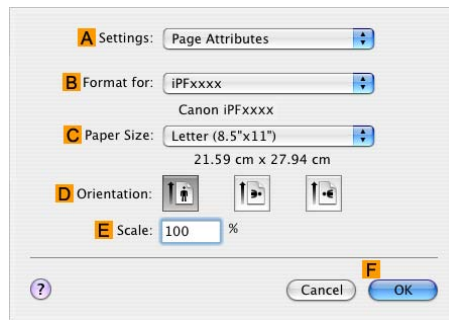

13. Select the **D Enlarged/Reduced Printing** check box.
14. Make sure **E Fit Media Size** is selected.
15. Click **ISO A3** in the **I Media Size** list.
16. Confirm the print settings, and then click **M Print** to start printing.

**Note**

- For tips on confirming print settings, see “Confirming Print Settings (Mac OS X)”. (→P.493)

Resizing Originals to Match the Paper Size (Mac OS 9)

This topic describes how to enlarge originals before printing to match the paper size, based on the following example.

- Document: Any Type
- Page size: A4 (210.0×297.0 mm)/Letter (8.3 × 11.7 in)
- Paper: Roll
- Paper type: Plain Paper
- Roll paper width: A2/A3 roll (420.0 mm [16.5 in])

1. Select the printer in **Chooser**.
2. Choose **Page Setup** from the application menu to display the **Page Attribute** dialog box.

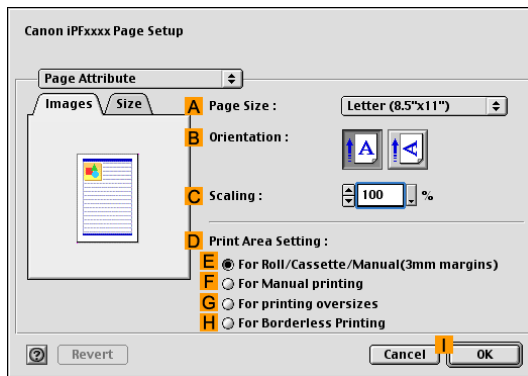

3. In **A Page Size**, click the size of the original. In this case, click **ISO A4**.
4. Click **I OK** to close the dialog box.
5. Choose **Print** in the application menu.
6. Make sure the **Main** pane is displayed.

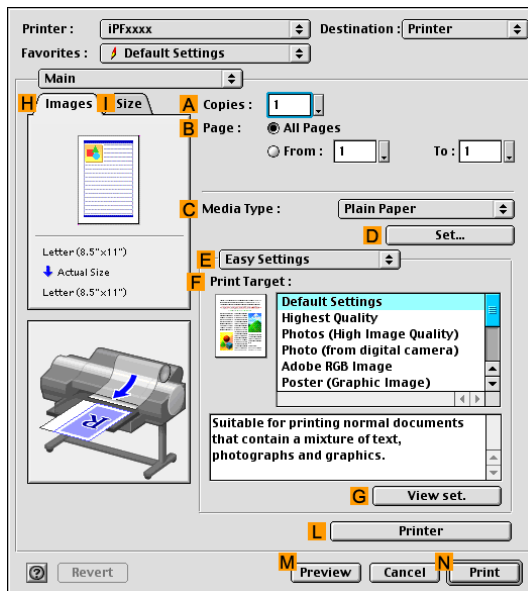

7. In the **C Media Type** list, select the type of paper that is loaded. In this case, click Plain Paper.
8. Select the printing application in the **F Print Target** list.
9. Access the **Finishing** pane.

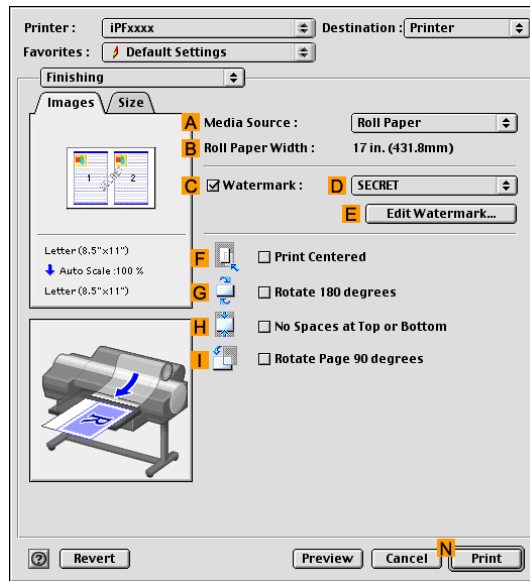

10. Click **Roll Paper** in the **A Media Source** list.
11. Make sure the width of the loaded roll is displayed in the **B Roll Paper Width** list-in this case, **ISO A2/A3 (420.0mm)**.



Note

- If the width of the loaded roll is not displayed in **B Roll Paper Width**, click **L Printer** on the **Main** pane and update the printer information.

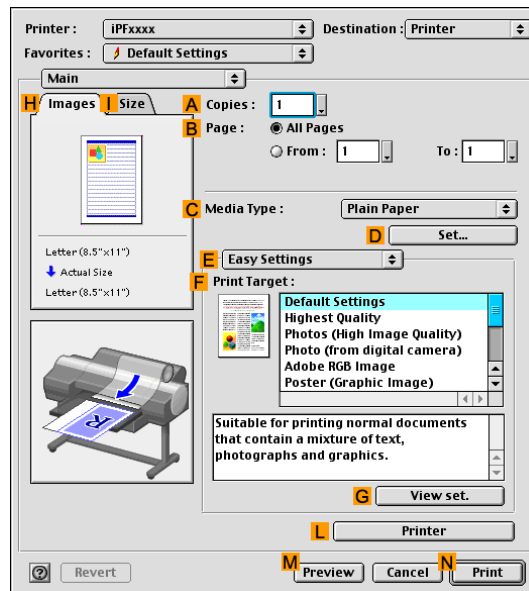

12. Access the **Page Setup** pane.

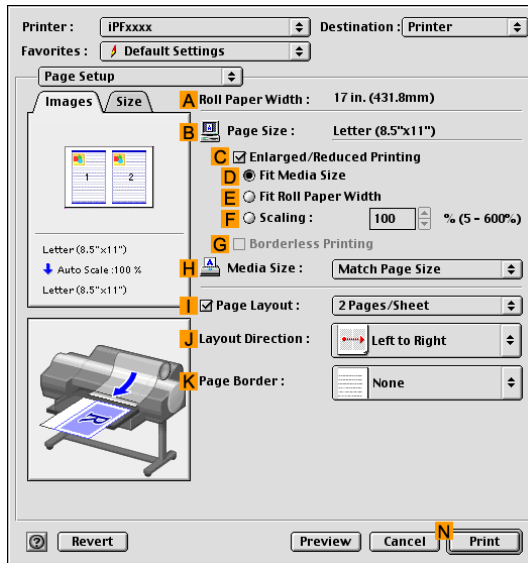

13. Make sure the **B Page Size** setting matches the original size as selected in **A Page Size** in the **Page Attribute** dialog box—in this case, **ISO A4**.

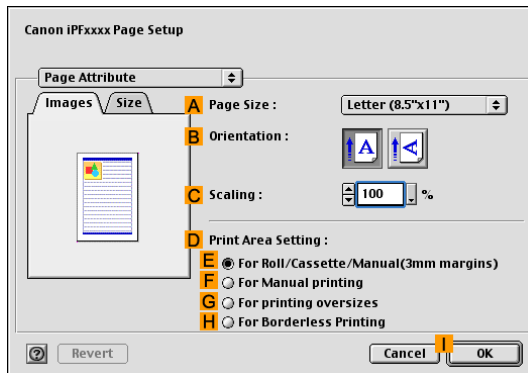

14. Select the **C Enlarged/Reduced Printing** check box.

15. Make sure **D Fit Media Size** is selected.

16. Click **ISO A3** in the **H Media Size** list.

17. Confirm the print settings, and then click **N Print** to start printing.



Note

- For tips on confirming print settings, see “Confirming Print Settings (Mac OS 9)”. (→P.518)

Printing at full size

Printing on Oversized Paper

Except in borderless printing, the actual printing area corresponds to your selected paper size minus the space for a margin. (→P.78) To print documents or images you prepare without a margin at actual size, use an oversized paper size.

For example, to print a A4-sized original without a margin at A4 size, print it on paper larger than A4 size and cut away the excess margin.



Note

- If you prepare an original for printing without a margin and print it on paper of regular size, the image near the edge will not be printed.

Oversize

The margin required by the printer is added around the “outside” of a regular paper size. For example, when printing a A4-sized original (210×297 mm), you have the following options.

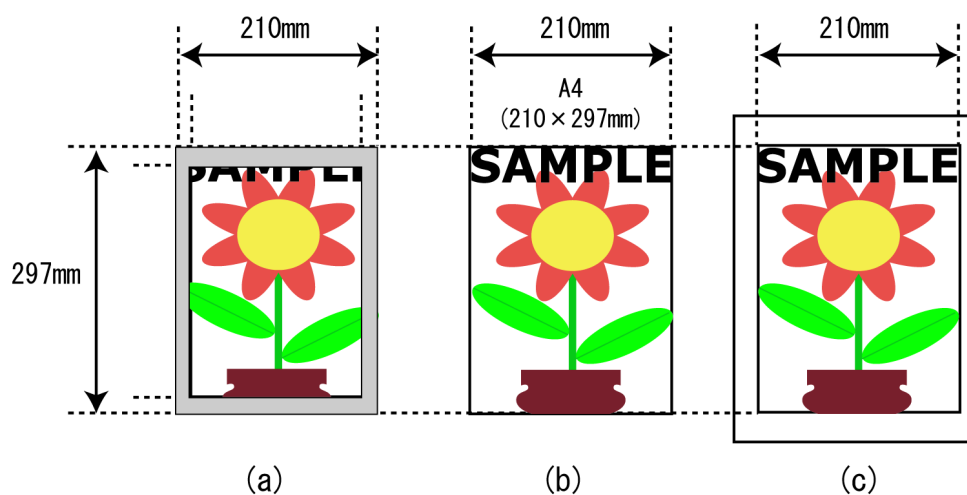

- Regular paper size: Gray area not printed
- Page Size
- Oversized paper size: Print area matches the page size (b)



Important

- When printing on oversize paper, load paper larger than the page size—a size that includes the margin required by the printer.
 - Sheets: Load paper that is at least 6 mm (0.24 in) wider and 26 mm (1 in) higher than the page size
 - Rolls: Load paper that is at least 6 mm (0.24 in) wider and 6 mm (0.24 in) higher than the page size
- Paper larger than the maximum size supported by the printer cannot be used as paper for oversized printing. (→P.113)



Note

- Oversized printing (selecting **Oversize** in **Page Size**) is only available in Windows. For oversized printing on sheets, choose **Manual** as the media source.
- To perform oversized printing on a Macintosh computer, you must specify a non-standard page size and print on it.
- To specify a non-standard paper size in oversized printing, register the paper size as a **Custom Media Size**. Oversized printing is not available with “Custom Size.” (→P.331)

For instructions on oversized printing, refer to the following topics, as appropriate for your computer and operating system.

- Printing at Full Size (Windows) (→P.290)
- Printing at Full Size (Mac OS X) (→P.292)
- Printing at Full Size (Mac OS 9) (→P.295)

Borderless Printing at Actual Size

Take advantage of borderless printing to print documents such as posters (made up mainly of photos or images) without a surrounding margin, or border.

Borderless Printing

In regular printing, a margin required by the printer is added around the original. With borderless printing, you can print documents without the margin, so that the printed image covers the entire surface of the paper.



Important

- Borderless printing is only available with rolls.
- Paper you can use for borderless printing is restricted to particular types of paper and rolls of particular widths. For information on types of paper compatible with borderless printing, refer to the Paper Reference Guide. (→P.108)
- If you use an A1 or A2 roll for borderless printing, insert the provided Spacer for Borderless Printing on the Roll Holder. (→P.144)
If you do not attach the Spacer for Borderless Printing, the Platen may be soiled from borderless printing.
- Paper incompatible with the printer's auto cut function can be printed without borders on the left and right sides only.
- These features cannot be used in combination with borderless printing: special page layouts, centering originals, and printing cut lines on rolls.
- You cannot have pages rotated 90 degrees to conserve paper if you have set up borderless printing at actual size or in combination with resizing originals to match the paper size.
- When borderless printing is used, the edge of the paper is cut during printing. Thus, ink density may be uneven at the edges. If you require higher image quality, specify **No** in **Auto Cut** in the printer driver. In this case, the paper can be printed without borders on the left and right sides only. After ejecting and cutting the printed document, use scissors to cut away the top and bottom edges.
- By factory default, the ink drying time is disabled for all paper. When you are using paper that takes longer for ink to adhere for borderless printing and the Cutter Unit touches printing surfaces that are not dry yet, it may damage the paper or the edge of the document that is cut, depending on frequency of use. In this case, follow these steps to change the ink drying time.
 - 1.** On the **Main** sheet of the printer driver, click **Settings** in **Media Type**.
 - 2.** Select the ink drying time in the **Between Pages** list of **Drying Time**.

Borderless Printing Method

Choose the method of borderless printing that suits the original, as desired.

Print Image with Actual Size

Prints originals at actual size, without enlarging or reducing them. Originals must be prepared in a size that exceeds the dimensions of the paper by 3 mm (0.12 in) on each side.

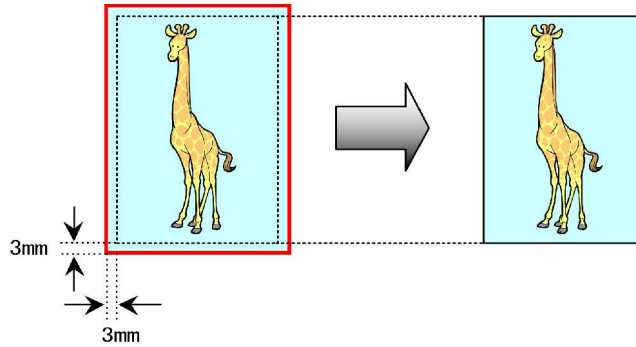

Note

- Not all page sizes are available.
- Even if you prepare originals of the same size as the paper size, the originals are automatically enlarged when you print borderlessly in combination with resizing originals to match the paper size. This may affect image quality. When image quality is most important, make the original 3 mm longer on each side than the paper size so that the image can be printed at actual size in borderless printing.

For instructions on borderless printing of photos and images at actual size, refer to the following topics, as appropriate for your computer and operating system.

- Borderless Printing at Actual Size (Windows) (→P.281)
- Borderless Printing at Actual Size (Mac OS X) (→P.283)
- Borderless Printing at Actual Size (Mac OS 9) (→P.286)

Borderless Printing at Actual Size (Windows)

This topic describes how to print borderlessly at actual size based on the following example.

If you use an A1 or A2 roll for borderless printing, insert the provided Spacer for Borderless Printing on the Roll Holder. (→P.144)

If you do not attach the Spacer for Borderless Printing, the Platen may be soiled from borderless printing.

- Document: Any type
- Page size: 10×12 inches (254.0×304.8 mm)
- Paper: Roll
- Paper type: Heavyweight Coated Paper
- Roll paper width: 10 inches (254.0 mm)

1. Create the original in the source application 3 mm (0.12 in) larger on each side than 254.0×304.8 mm (10 × 12 in) -that is, 260.0×310.8 mm (10.2 × 12.2 in)



Note

- If you can specify the margin, as in Microsoft Word, set the margin at 0 mm. For instructions on specifying the margin, refer to the software documentation.
- The extra 3 mm (0.12 in) on each side will not be printed. Create the original so that it fits inside the paper area to be printed on.

2. Choose **Print** in the application menu.
3. Select the printer in the dialog box, and then display the printer driver dialog box. (→P.473)
4. Make sure the **Main** sheet is displayed.

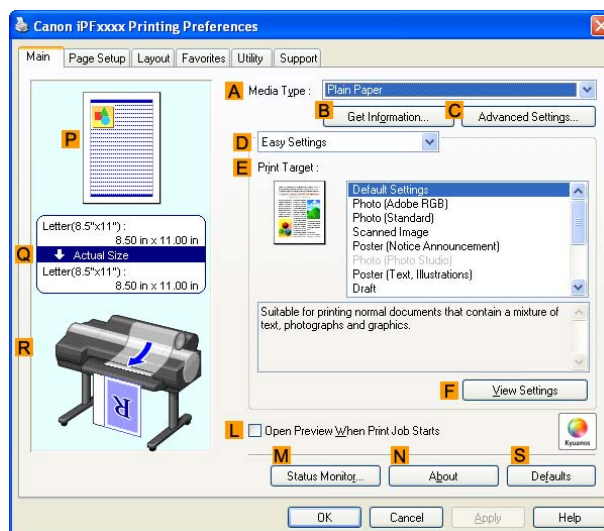

5. In the **A Media Type** list, select the type of paper that is loaded. In this case, click Heavyweight Coated Paper.
6. Select the print target in the **E Print Target** list.

7. Click the **Page Setup** tab to display the **Page Setup** sheet.

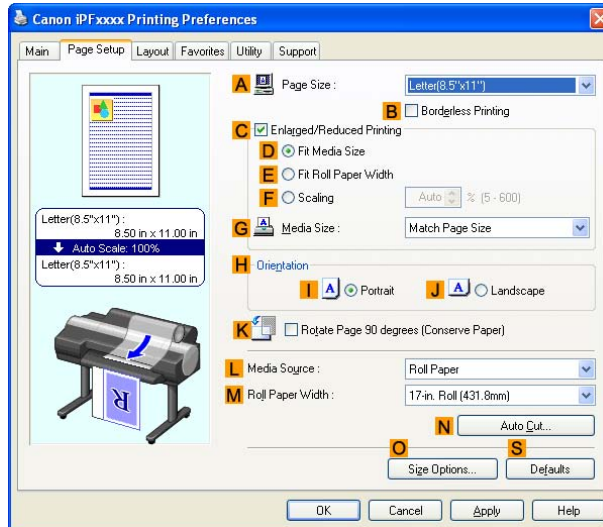

8. In the **A Page Size** list, click the size of the original as specified in the source application. In this case, click **10"x12"**.

9. Click **Roll Paper** in the **L Media Source** list.

10. Select the **B Borderless Printing** check box to display the **Information** dialog box.

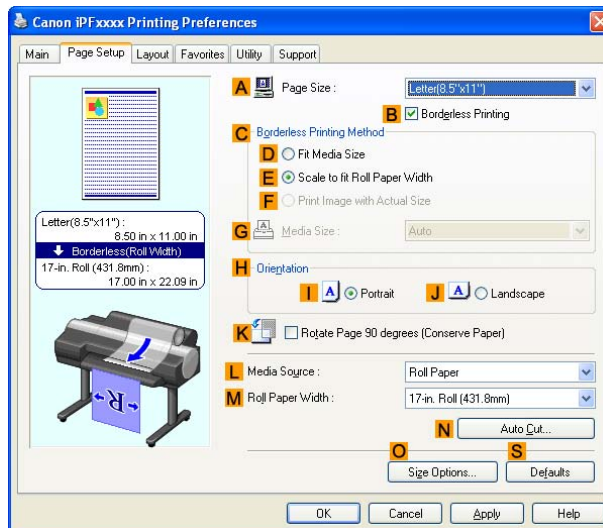

11. Select the width of the loaded roll in the **Roll Paper Width** list-in this case, click **10-in. Roll (254.0mm)**.

12. Click **OK** to close the **Information** dialog box.

13. In **C Borderless Printing Method**, click **F Print Image with Actual Size**.

14. Confirm the print settings and print as desired.



Note

- For tips on confirming print settings, see “Confirming Print Settings (Windows)”. (→P.443)

Borderless Printing at Actual Size (Mac OS X)

This topic describes how to print borderlessly at actual size based on the following example.

If you use an A1 or A2 roll for borderless printing, insert the provided Spacer for Borderless Printing on the Roll Holder. (→P.144)

The platen may be soiled from borderless printing if you do not attach it.

- Document: Any type
- Page size: 10 × 12 inches (254.0×304.8 mm)-Borderless
- Paper: Roll
- Paper type: Heavyweight Coated Paper
- Roll paper width: 10 inches (254.0 mm)

1. Choose **Page Setup** from the application menu to display the **Page Attribute** dialog box.

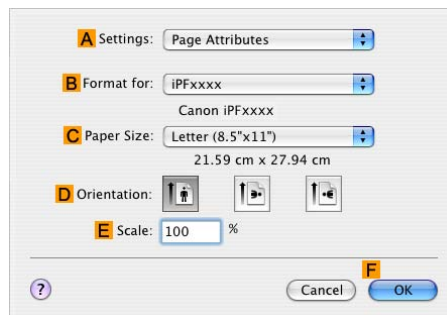

2. Select the printer in the **B Format for** list.

3. In the **C Paper Size** list, choose a paper size supported for borderless printing. Here, click **10"x12" - Borderless**.



Note

- Paper sizes supported for borderless printing are indicated by “-Borderless.”

4. Click **F OK** to close the dialog box.

5. In the application, create an original that takes up the entire space of the paper size.

6. Choose **Print** in the application menu.

7. Access the **Main** pane.

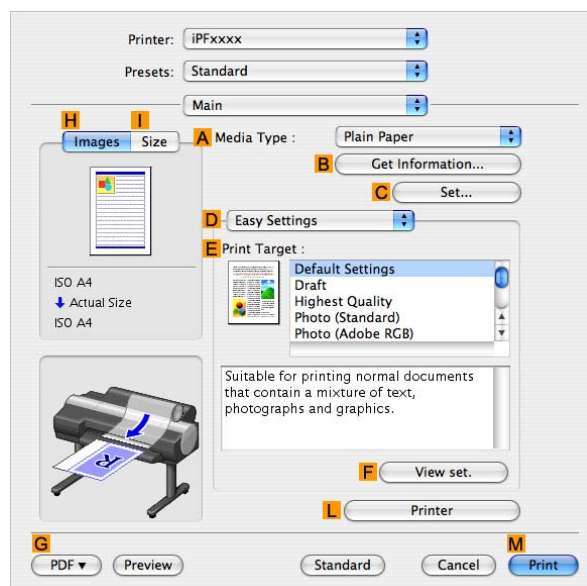

8. In the **A Media Type** list, select the type of paper that is loaded. In this case, click Heavyweight Coated Paper.
9. Select the print target in the **E Print Target** list.
10. Access the **Page Setup** pane.

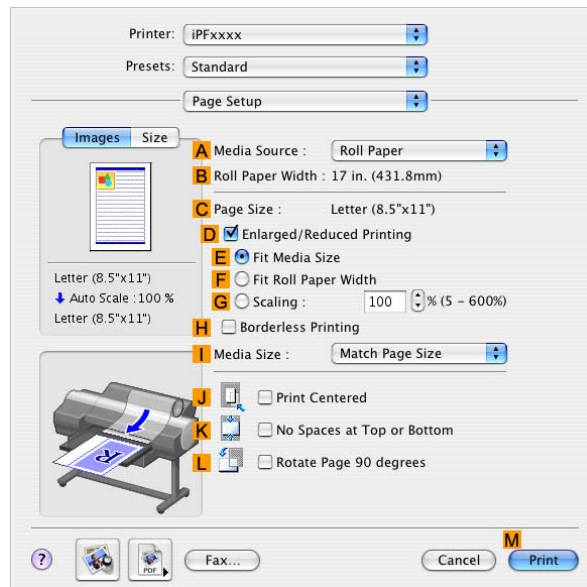

11. Click **Roll Paper** in the **A Media Source** list.
12. Confirm that the roll paper width matches the paper size. Make sure the width of the loaded roll is displayed in the **B Roll Paper Width** list-in this case, **10 in. (254.0mm)**.



Note

- If the width of the loaded roll is not displayed in **B Roll Paper Width**, click **L Printer Information** on the **Main** pane and update the printer information.

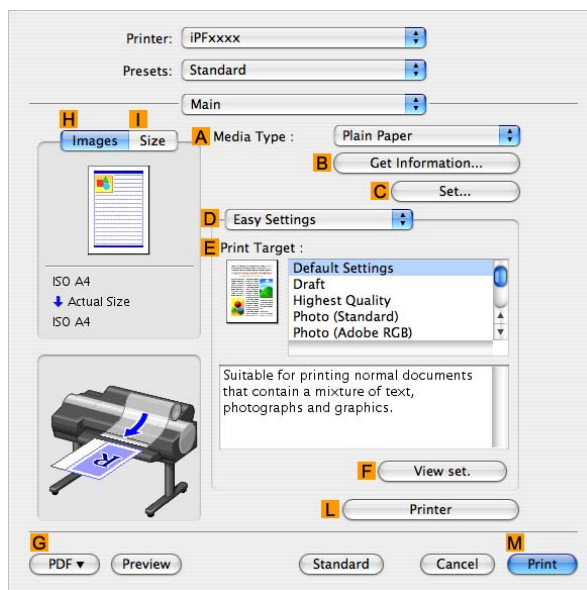

13. Make sure the **C Page Size** setting matches the original size as selected in **C Paper Size** in the **Page Attribute** dialog box-in this case, **10"x12" - Borderless**.

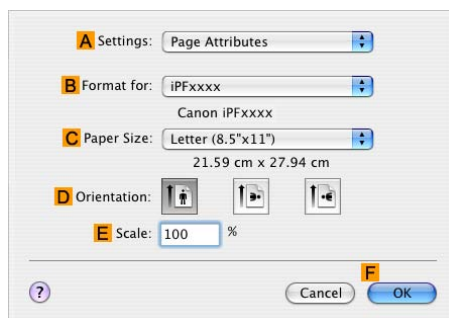

14. Confirm the print settings, and then click **M Print** to start printing.



Note

- For tips on confirming print settings, see “Confirming Print Settings (Mac OS X)”. (→P.493)

Borderless Printing at Actual Size (Mac OS 9)

This topic describes how to print borderlessly at actual size based on the following example.

If you use an A1 or A2 roll for borderless printing, insert the provided Spacer for Borderless Printing on the Roll Holder. (→P.144)

If you do not attach the Spacer for Borderless Printing, the Platen may be soiled from borderless printing.

- Document: Any type
- Page size: 10 × 12 inches (254.0×304.8 mm)-Borderless
- Paper: Roll
- Paper type: Heavyweight Coated Paper
- Roll width: 10 inches (254.0 mm)

1. Select the printer in **Chooser**.
2. Choose **Page Setup** from the application menu to display the **Page Attribute** dialog box.

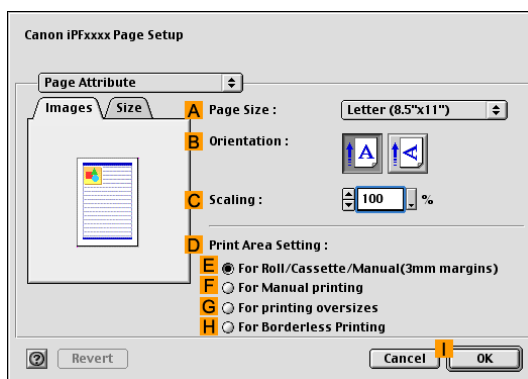

3. In **D Print Area Setting**, click **H For Broderless Printing**.
4. In the **A Page Size** list, choose a paper size supported for borderless printing. Here, click **10"x12" - Borderless**.



Note

- Paper sizes supported for borderless printing are indicated by “-Borderless.”

5. Click **I OK** to close the dialog box.
6. In the application, create an original that takes up the entire space of the paper size.
7. Choose **Print** in the application menu.

8. Make sure the **Main** pane is displayed.

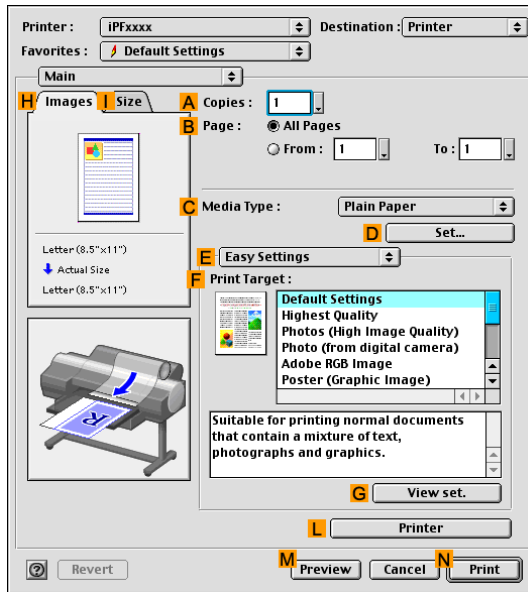

9. In the **C Media Type** list, select the type of paper that is loaded. In this case, click Heavyweight Coated Paper.

10. Select the print target in the **F Print Target** list.

11. Access the **Finishing** pane.

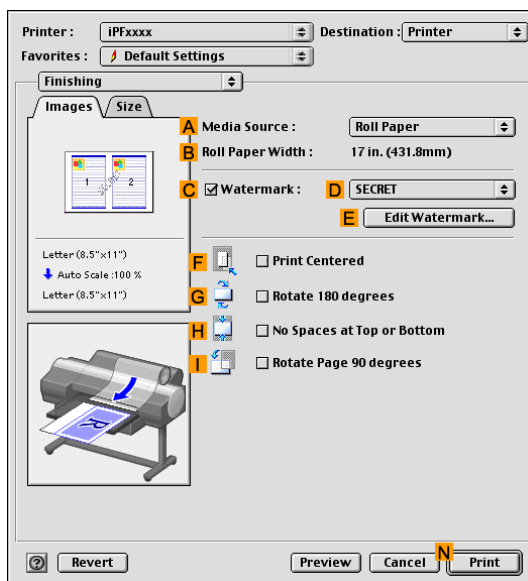

12. Click **Roll Paper** in the **A Media Source** list.

13. Confirm that the roll paper width matches the paper size.

Make sure the width of the loaded roll is displayed in the **B Roll Paper Width** list-in this case, **10 in. (254.0mm)**.



Note

- If the width of the loaded roll is not displayed in **B Roll Paper Width**, click **L Printer** on the **Main** pane and update the printer information.

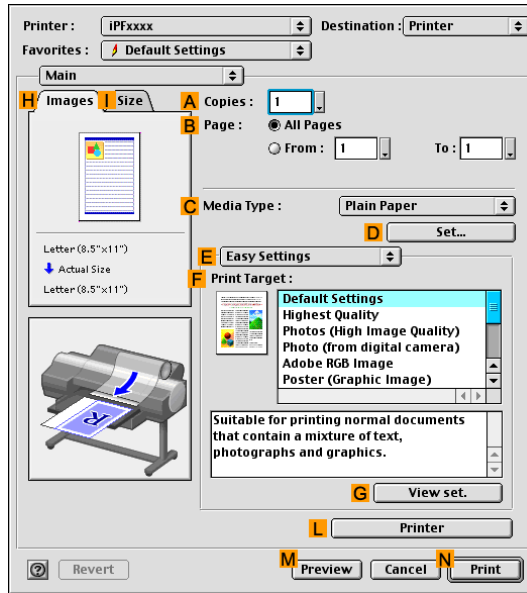

14. Access the **Page Setup** pane.

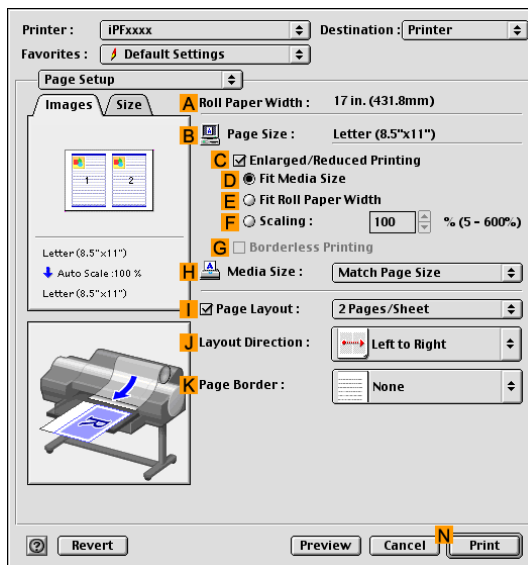

15. Make sure the **B Page Size** setting matches the original size as selected in **A Page Size** in the **Page Attribute** dialog box-in this case, **10"x12"**.

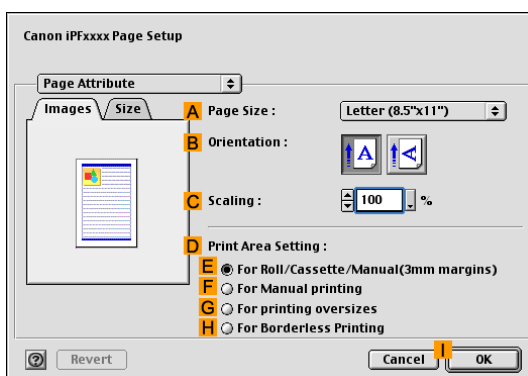

16. Confirm the print settings, and click **N Print** to start printing.



Note

- For tips on confirming print settings, see "Confirming Print Settings (Mac OS 9)". (→P.518)

Printing at Full Size (Windows)

This topic describes how to print at full size based on the following example. (Oversized Printing)

- Document: Any Type
- Page Size: A4 (210.0×297.0 mm)/Letter (8.3 × 11.7 in)
- Paper: Roll
- Paper type: Plain Paper
- Roll paper width: A2/A3 roll (420.0 mm [16.5 in])

1. Choose **Print** in the application menu.
2. Select the printer in the dialog box, and then display the printer driver dialog box. (→P.473)
3. Make sure the **Main** sheet is displayed.

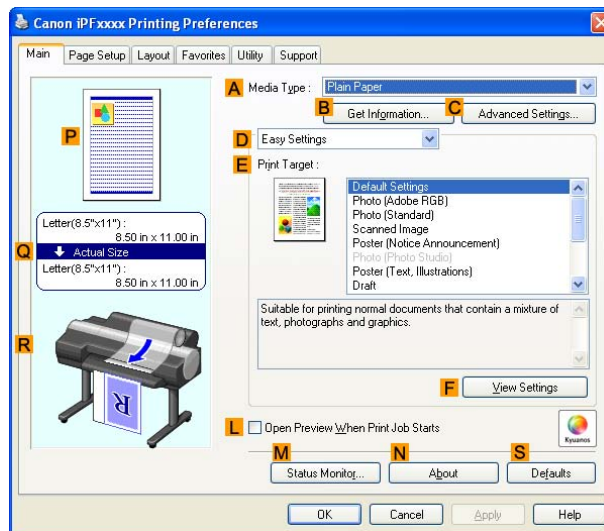

4. In the **A Media Type** list, select the type of paper that is loaded. In this case, click Plain Paper.
5. Click the **Page Setup** tab to display the **Page Setup** sheet.

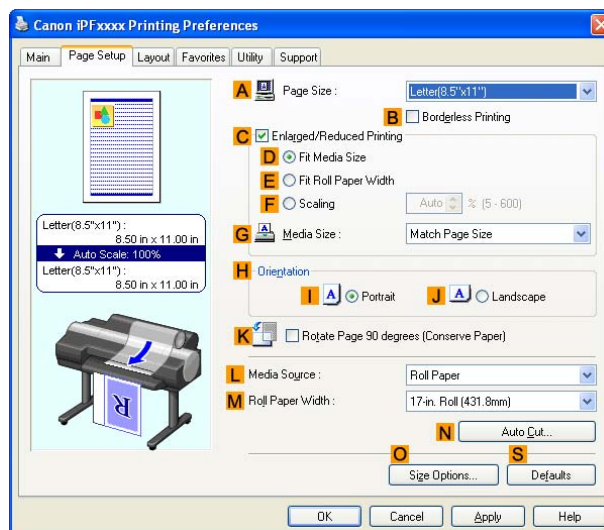

6. Click **O Size Options** to display the **Media Size Options** dialog box.
7. In the **Media Size Options** dialog box, select the **Oversize** check box in **Display Series**.
8. Click **OK** to close the **Media Size Options** dialog box.

9. Click **Oversize - ISO A4** in the **A Page Size** list.
10. Click **Roll Paper** in the **L Media Source** list.
11. Select the width of the loaded roll in the **M Roll Paper Width** list-in this case, **ISO A2/A3 Roll (420.0mm)**.
12. Confirm the print settings and print as desired.



Note

- For tips on confirming print settings, see “Confirming Print Settings (Windows)”. (→P.443)



Note

- You can select **Oversize** in **Display Series** to make all oversized versions of paper in the selected **Display Series** available for printing. These sizes are displayed in the **Page Size** list in the format **Oversize - xxxxxx**.

Printing at Full Size (Mac OS X)

This topic describes how to print at full size based on the following example. (Oversized Printing)

- Document: Any type
- Page size: A4 (210.0×297.0 mm)/Letter (8.3 × 11.7 in)
- Paper: Roll
- Paper type: Plain Paper
- Roll paper width: A2/A3 roll (420.0 mm [16.5 in])

1. Choose **Page Setup** from the application menu to display the **Page Attribute** dialog box.

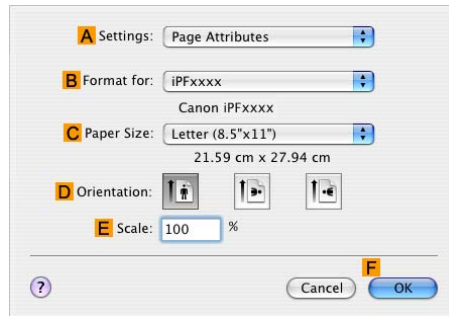

2. Select the printer in the **B Format for** list.

3. In **C Paper Size**, click the size of the original. In this case, click **ISO A4 - Oversize**.



Note

- For oversized printing, choose paper identified by the regular paper name followed by “- Oversize.”

4. Click **F OK** to close the dialog box.

5. Choose **Print** in the application menu.

6. Access the **Main** pane.

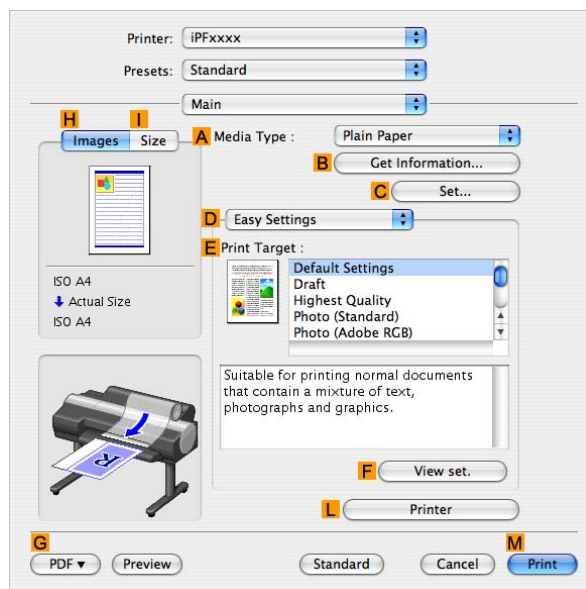

7. In the **A Media Type** list, select the type of paper that is loaded. In this case, click Plain Paper.

8. Select the printing application in the **E Print Target** list.

9. Access the **Page Setup** pane.

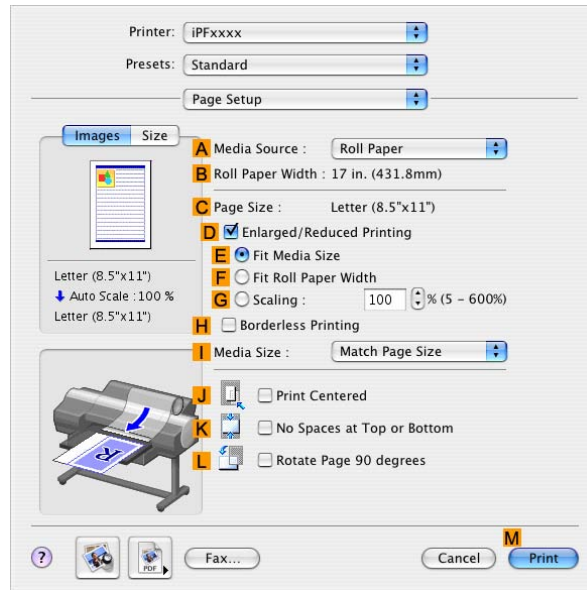

10. Click **Roll Paper** in the **A Media Source** list.

11. Make sure the width of the loaded roll is displayed in the **B Roll Paper Width** list-in this case, **ISO A2/A3 (420.0mm)**.



Note

- If the width of the loaded roll is not displayed in **B Roll Paper Width**, click **L Printer Information** on the **Main** pane and update the printer information.

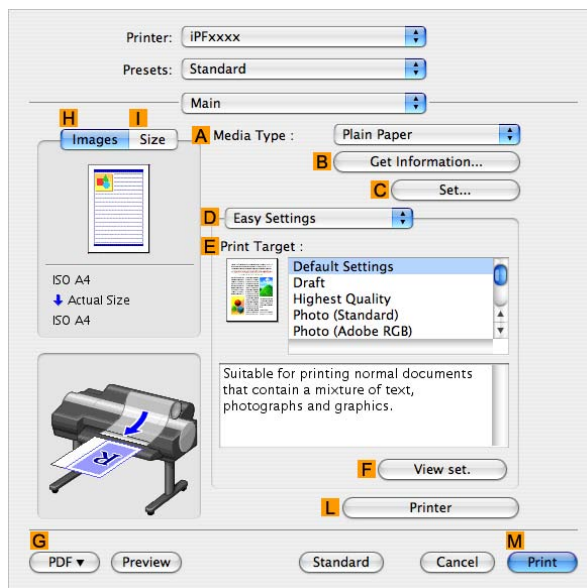

12. Make sure **C Page Size** shows the original size as specified in **C Paper Size** in the **Page Attribute** dialog box-in this case, **ISO A4 - Oversize**.

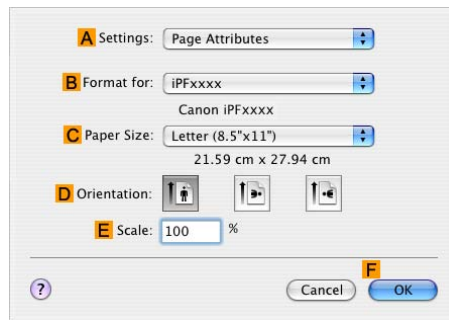

13. Confirm the print settings, and then click **M Print** to start printing.



Note

- For tips on confirming print settings, see “Confirming Print Settings (Mac OS X)”. (→P.493)

Printing at Full Size (Mac OS 9)

This topic describes how to print at full size based on the following example. (Oversized Printing)

- Document: Any type
- Page size: A4 (210.0×297.0 mm)/Letter (8.3 × 11.7 in)
- Paper: Roll
- Paper type: Plain Paper
- Roll paper width: A2/A3 roll (420.0 mm [16.5 in])

1. Select the printer in **Chooser**.
2. Choose **Page Setup** from the application menu to display the **Page Attribute** dialog box.

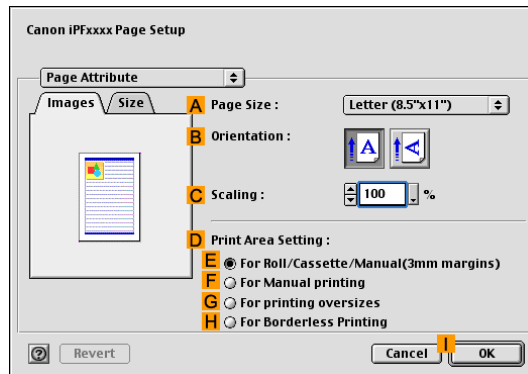

3. In **D Print Area Setting**, click **G For printing oversizes**.
4. In the **A Page Size** list, click the size of the original. In this case, click **ISO A4**.
5. Click **I OK** to close the dialog box.
6. Choose **Print** in the application menu.
7. Make sure the **Main** pane is displayed.

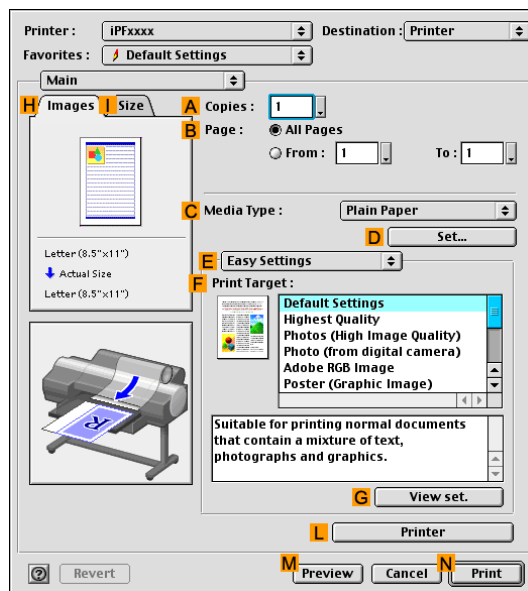

8. In the **C Media Type** list, select the type of paper that is loaded. In this case, click Plain Paper.
9. Select the printing application in the **F Print Target** list.

10. Access the **Finishing** pane.

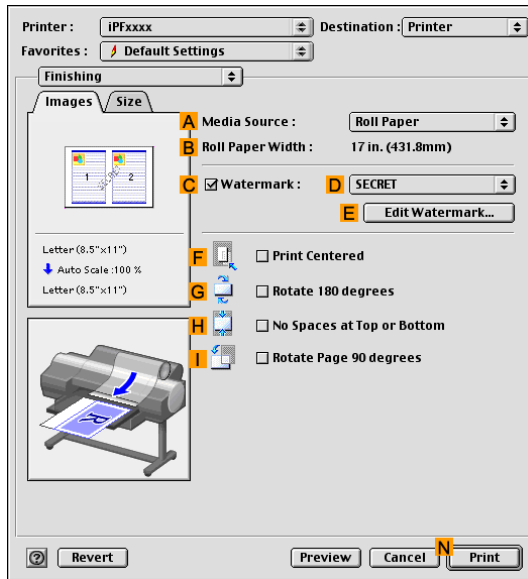

11. Click **Roll Paper** in the **A Media Source** list.

12. Make sure the width of the loaded roll is displayed in the **B Roll Paper Width** list-in this case, **ISO A2/A3 (420.0mm)**.



Note

- If the width of the loaded roll is not displayed in **B Roll Paper Width**, click **L Printer** on the **Main** pane and update the printer information.

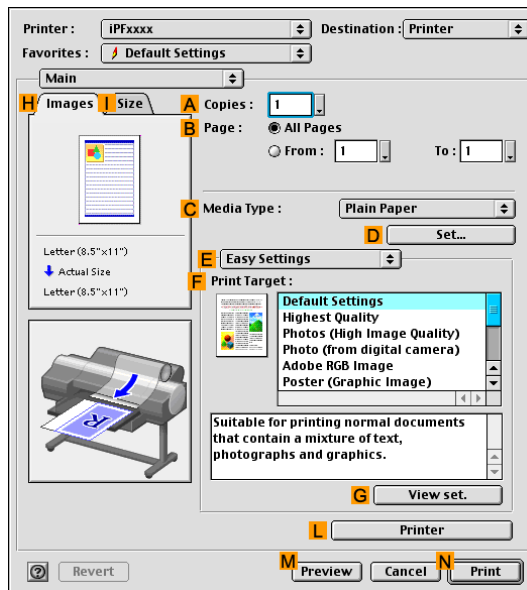

13. Confirm the print settings, and then click **N Print** to start printing.



Note

- For tips on confirming print settings, see “Confirming Print Settings (Mac OS 9)”. (→P.518)

Borderless Printing

Borderless Printing on Paper of Equivalent Size

Take advantage of borderless printing to print documents such as posters (made up mainly of photos or images) without a surrounding margin, or border.

Borderless Printing

In regular printing, a margin required by the printer is added around the original. With borderless printing, you can print documents without the margin, so that the printed image covers the entire surface of the paper.



Important

- Borderless printing is only available with rolls.
- Paper you can use for borderless printing is restricted to particular types of paper and rolls of particular widths. For information on types of paper compatible with borderless printing, refer to the Paper Reference Guide. (→P.108)
- If you use an A1 or A2 roll for borderless printing, insert the provided Spacer for Borderless Printing on the Roll Holder. (→P.144)
If you do not attach the Spacer for Borderless Printing, the Platen may be soiled from borderless printing.
- Paper incompatible with the printer's auto cut function can be printed without borders on the left and right sides only.
- These features cannot be used in combination with borderless printing: special page layouts, centering originals, and printing cut lines on rolls.
- You cannot have pages rotated 90 degrees to conserve paper if you have set up borderless printing at actual size or in combination with resizing originals to match the paper size.
- When borderless printing is used, the edge of the paper is cut during printing. Thus, ink density may be uneven at the edges. If you require higher image quality, specify **No** in **Auto Cut** in the printer driver. In this case, the paper can be printed without borders on the left and right sides only. After ejecting and cutting the printed document, use scissors to cut away the top and bottom edges.
- By factory default, the ink drying time is disabled for all paper. When you are using paper that takes longer for ink to adhere for borderless printing and the Cutter Unit touches printing surfaces that are not dry yet, it may damage the paper or the edge of the document that is cut, depending on frequency of use. In this case, follow these steps to change the ink drying time.
 1. On the **Main** sheet of the printer driver, click **Settings** in **Media Type**.
 2. Select the ink drying time in the **Between Pages** list of **Drying Time**.

Borderless Printing Method

Choose the method of borderless printing that suits the original, as desired.

Fit Media Size

Enlarge or reduce the original to match the size of the paper you are using.

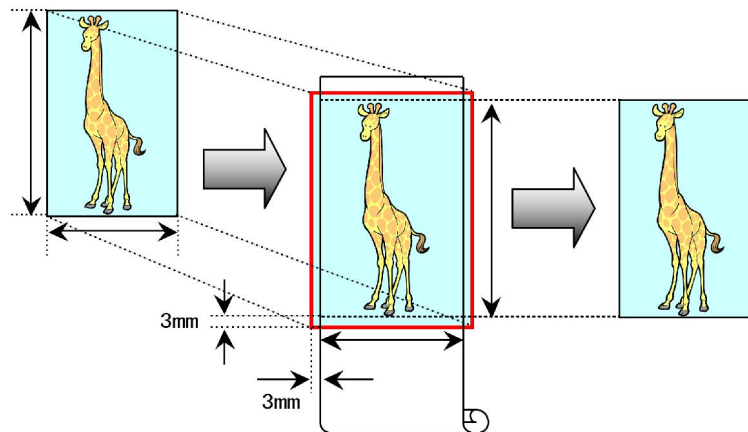

Note

- The printer driver automatically enlarges originals 3 mm (0.12 in) past the dimensions of the paper on each side. The 3 mm portion beyond the edge on each side is not printed.

For instructions on borderless printing of photos, images, and other documents to match the paper size, refer to the following topics, as appropriate for your computer and operating system.

- Borderless Printing by Resizing Originals to Match the Paper Size (Windows) (→P.321)
- Borderless Printing by Resizing Originals to Match the Paper Size (Mac OS X) (→P.323)
- Borderless Printing by Resizing Originals to Match the Paper Size (Mac OS 9) (→P.326)

Borderless Printing by Resizing Originals to Fit the Roll Width

Take advantage of borderless printing to print documents such as posters (made up mainly of photos or images) without a surrounding margin, or border.

Borderless Printing

In regular printing, a margin required by the printer is added around the original. With borderless printing, you can print documents without the margin, so that the printed image covers the entire surface of the paper.



Important

- Borderless printing is only available with rolls.
- Paper you can use for borderless printing is restricted to particular types of paper and rolls of particular widths. For information on types of paper compatible with borderless printing, refer to the Paper Reference Guide. (→P.108)
- If you use an A1 or A2 roll for borderless printing, insert the provided Spacer for Borderless Printing on the Roll Holder. (→P.144)
If you do not attach the Spacer for Borderless Printing, the Platen may be soiled from borderless printing.
- Paper incompatible with the printer's auto cut function can be printed without borders on the left and right sides only.
- These features cannot be used in combination with borderless printing: special page layouts, centering originals, and printing cut lines on rolls.
- You cannot have pages rotated 90 degrees to conserve paper if you have set up borderless printing at actual size or in combination with resizing originals to match the paper size.
- When borderless printing is used, the edge of the paper is cut during printing. Thus, ink density may be uneven at the edges. If you require higher image quality, specify **No** in **Auto Cut** in the printer driver. In this case, the paper can be printed without borders on the left and right sides only. After ejecting and cutting the printed document, use scissors to cut away the top and bottom edges.
- By factory default, the ink drying time is disabled for all paper. When you are using paper that takes longer for ink to adhere for borderless printing and the Cutter Unit touches printing surfaces that are not dry yet, it may damage the paper or the edge of the document that is cut, depending on frequency of use. In this case, follow these steps to change the ink drying time.
 1. On the **Main** sheet of the printer driver, click **Settings** in **Media Type**.
 2. Select the ink drying time in the **Between Pages** list of **Drying Time**.

Borderless Printing Method

Choose the method of borderless printing that suits the original, as desired.

Scale to fit Roll Paper Width

Enlarge or reduce the original as a whole to match the roll paper width.

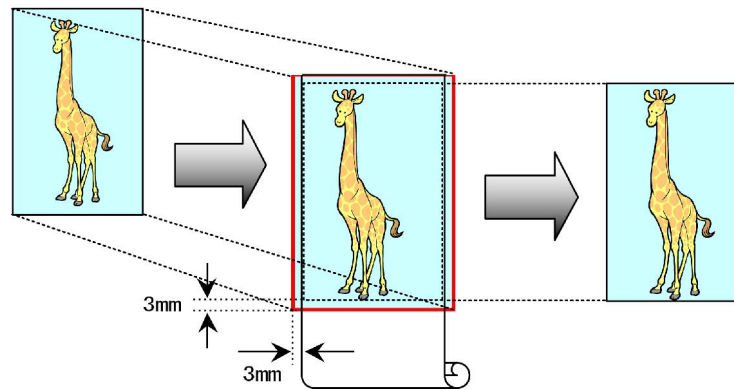

Note

- You can combine this function with rotating pages 90 degrees before printing so that the original width (relative to portrait orientation) matches the roll paper width in borderless printing.

For instructions on borderless printing of photos, images, and other documents to match the roll paper width, refer to the following topics, as appropriate for your computer and operating system.

- Borderless Printing by Resizing Originals to Fit the Roll Width (Windows) (→P.312)
- Borderless Printing by Resizing Originals to Fit the Roll Width (Mac OS X) (→P.314)
- Borderless Printing by Resizing Originals to Fit the Roll Width (Mac OS 9) (→P.317)

Borderless Printing at Actual Size

Take advantage of borderless printing to print documents such as posters (made up mainly of photos or images) without a surrounding margin, or border.

Borderless Printing

In regular printing, a margin required by the printer is added around the original. With borderless printing, you can print documents without the margin, so that the printed image covers the entire surface of the paper.



Important

- Borderless printing is only available with rolls.
- Paper you can use for borderless printing is restricted to particular types of paper and rolls of particular widths. For information on types of paper compatible with borderless printing, refer to the Paper Reference Guide. (→P.108)
- If you use an A1 or A2 roll for borderless printing, insert the provided Spacer for Borderless Printing on the Roll Holder. (→P.144)
If you do not attach the Spacer for Borderless Printing, the Platen may be soiled from borderless printing.
- Paper incompatible with the printer's auto cut function can be printed without borders on the left and right sides only.
- These features cannot be used in combination with borderless printing: special page layouts, centering originals, and printing cut lines on rolls.
- You cannot have pages rotated 90 degrees to conserve paper if you have set up borderless printing at actual size or in combination with resizing originals to match the paper size.
- When borderless printing is used, the edge of the paper is cut during printing. Thus, ink density may be uneven at the edges. If you require higher image quality, specify **No** in **Auto Cut** in the printer driver. In this case, the paper can be printed without borders on the left and right sides only. After ejecting and cutting the printed document, use scissors to cut away the top and bottom edges.
- By factory default, the ink drying time is disabled for all paper. When you are using paper that takes longer for ink to adhere for borderless printing and the Cutter Unit touches printing surfaces that are not dry yet, it may damage the paper or the edge of the document that is cut, depending on frequency of use. In this case, follow these steps to change the ink drying time.
 - 1.** On the **Main** sheet of the printer driver, click **Settings** in **Media Type**.
 - 2.** Select the ink drying time in the **Between Pages** list of **Drying Time**.

Borderless Printing Method

Choose the method of borderless printing that suits the original, as desired.

Print Image with Actual Size

Prints originals at actual size, without enlarging or reducing them. Originals must be prepared in a size that exceeds the dimensions of the paper by 3 mm (0.12 in) on each side.

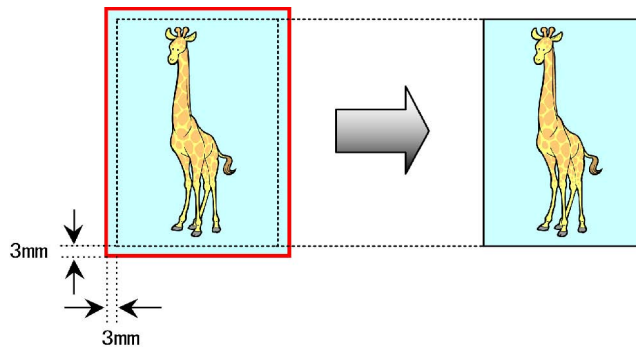

Note

- Not all page sizes are available.
- Even if you prepare originals of the same size as the paper size, the originals are automatically enlarged when you print borderlessly in combination with resizing originals to match the paper size. This may affect image quality. When image quality is most important, make the original 3 mm longer on each side than the paper size so that the image can be printed at actual size in borderless printing.

For instructions on borderless printing of photos and images at actual size, refer to the following topics, as appropriate for your computer and operating system.

- [Borderless Printing at Actual Size \(Windows\) \(→P.281\)](#)
- [Borderless Printing at Actual Size \(Mac OS X\) \(→P.283\)](#)
- [Borderless Printing at Actual Size \(Mac OS 9\) \(→P.286\)](#)

Borderless Printing at Actual Size (Windows)

This topic describes how to print borderlessly at actual size based on the following example.

If you use an A1 or A2 roll for borderless printing, insert the provided Spacer for Borderless Printing on the Roll Holder. (→P.144)

If you do not attach the Spacer for Borderless Printing, the Platen may be soiled from borderless printing.

- Document: Any type
- Page size: 10×12 inches (254.0×304.8 mm)
- Paper: Roll
- Paper type: Heavyweight Coated Paper
- Roll paper width: 10 inches (254.0 mm)

1. Create the original in the source application 3 mm (0.12 in) larger on each side than 254.0×304.8 mm (10 × 12 in) -that is, 260.0×310.8 mm (10.2 × 12.2 in)



Note

- If you can specify the margin, as in Microsoft Word, set the margin at 0 mm. For instructions on specifying the margin, refer to the software documentation.
- The extra 3 mm (0.12 in) on each side will not be printed. Create the original so that it fits inside the paper area to be printed on.

2. Choose **Print** in the application menu.
3. Select the printer in the dialog box, and then display the printer driver dialog box. (→P.473)
4. Make sure the **Main** sheet is displayed.

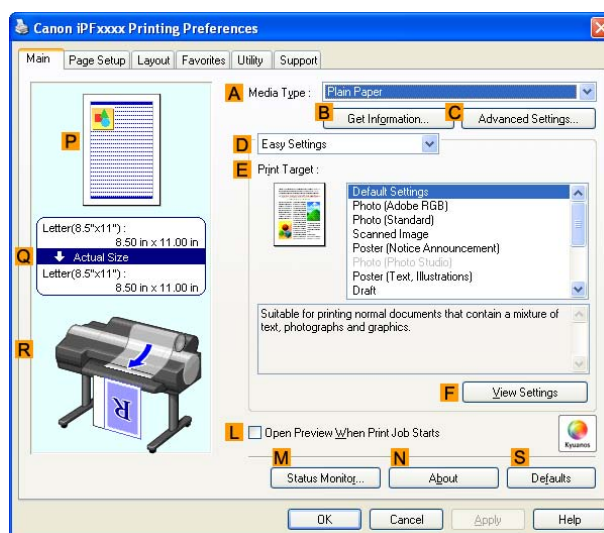

5. In the **A Media Type** list, select the type of paper that is loaded. In this case, click Heavyweight Coated Paper.
6. Select the print target in the **E Print Target** list.

7. Click the **Page Setup** tab to display the **Page Setup** sheet.

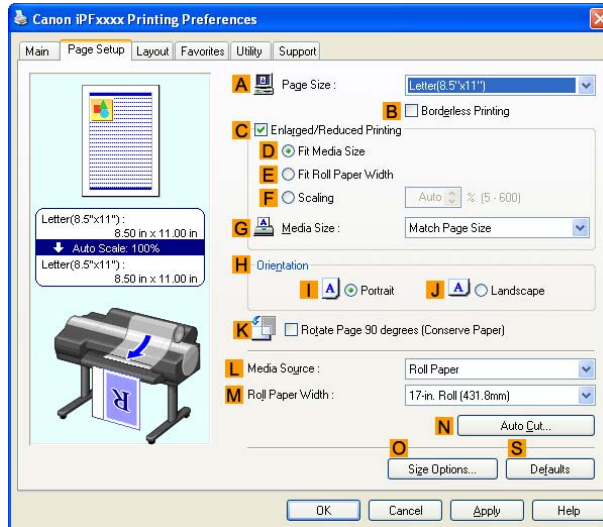

8. In the **A Page Size** list, click the size of the original as specified in the source application. In this case, click **10"x12"**.

9. Click **Roll Paper** in the **L Media Source** list.

10. Select the **B Borderless Printing** check box to display the **Information** dialog box.

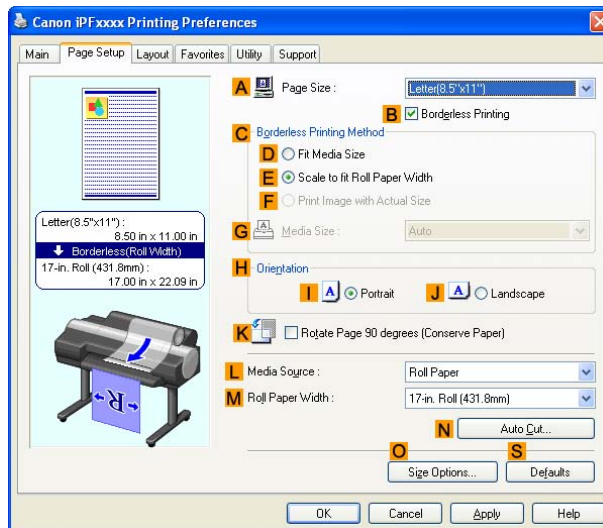

11. Select the width of the loaded roll in the **Roll Paper Width** list-in this case, click **10-in. Roll (254.0mm)**.

12. Click **OK** to close the **Information** dialog box.

13. In **C Borderless Printing Method**, click **F Print Image with Actual Size**.

14. Confirm the print settings and print as desired.



Note

- For tips on confirming print settings, see “Confirming Print Settings (Windows)”. (→P.443)

Borderless Printing at Actual Size (Mac OS X)

This topic describes how to print borderlessly at actual size based on the following example.

If you use an A1 or A2 roll for borderless printing, insert the provided Spacer for Borderless Printing on the Roll Holder. (→P.144)

The platen may be soiled from borderless printing if you do not attach it.

- Document: Any type
- Page size: 10 × 12 inches (254.0×304.8 mm)-Borderless
- Paper: Roll
- Paper type: Heavyweight Coated Paper
- Roll paper width: 10 inches (254.0 mm)

1. Choose **Page Setup** from the application menu to display the **Page Attribute** dialog box.

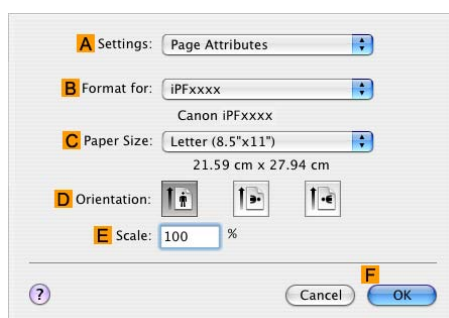

2. Select the printer in the **B Format for** list.

3. In the **C Paper Size** list, choose a paper size supported for borderless printing. Here, click **10"x12" - Borderless**.



Note

- Paper sizes supported for borderless printing are indicated by “-Borderless.”

4. Click **F OK** to close the dialog box.

5. In the application, create an original that takes up the entire space of the paper size.

6. Choose **Print** in the application menu.

7. Access the **Main** pane.

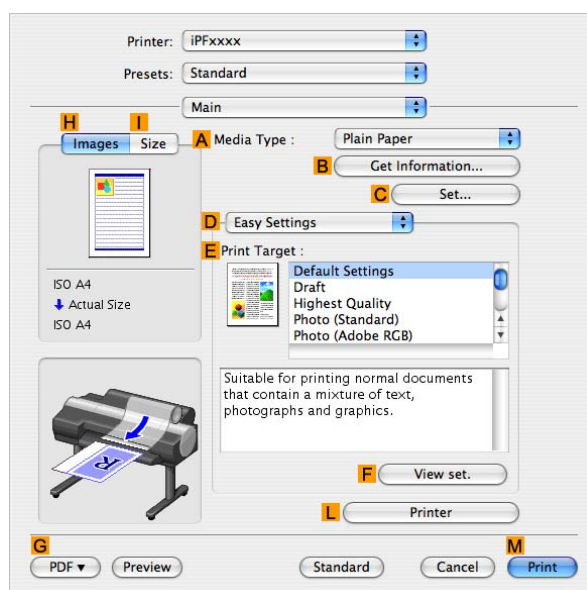

8. In the **A Media Type** list, select the type of paper that is loaded. In this case, click Heavyweight Coated Paper.
9. Select the print target in the **E Print Target** list.
10. Access the **Page Setup** pane.

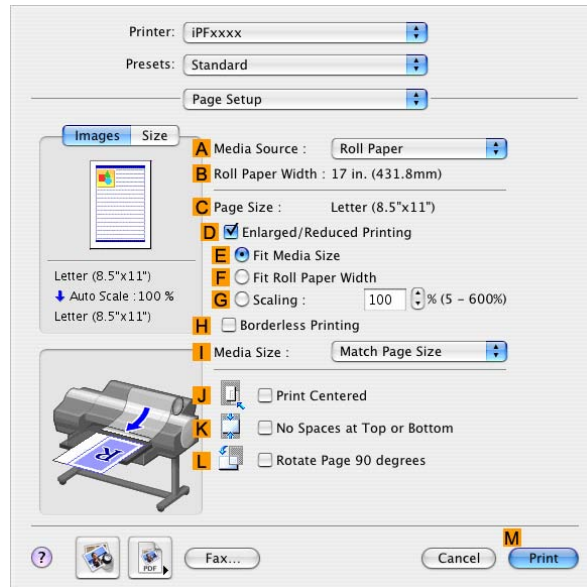

11. Click **Roll Paper** in the **A Media Source** list.
12. Confirm that the roll paper width matches the paper size. Make sure the width of the loaded roll is displayed in the **B Roll Paper Width** list-in this case, **10 in. (254.0mm)**.



Note

- If the width of the loaded roll is not displayed in **B Roll Paper Width**, click **L Printer Information** on the **Main** pane and update the printer information.

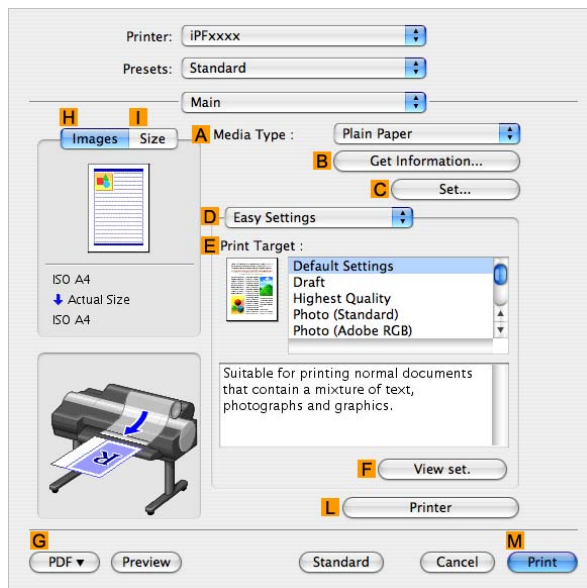

13. Make sure the **C Page Size** setting matches the original size as selected in **C Paper Size** in the **Page Attribute** dialog box-in this case, **10"x12" - Borderless**.

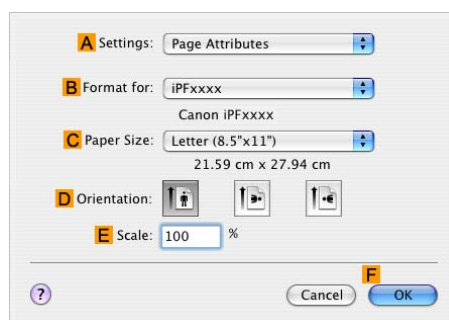

14. Confirm the print settings, and then click **M Print** to start printing.



Note

- For tips on confirming print settings, see “Confirming Print Settings (Mac OS X)”. (→P.493)

Borderless Printing at Actual Size (Mac OS 9)

This topic describes how to print borderlessly at actual size based on the following example.

If you use an A1 or A2 roll for borderless printing, insert the provided Spacer for Borderless Printing on the Roll Holder. (→P.144)

If you do not attach the Spacer for Borderless Printing, the Platen may be soiled from borderless printing.

- Document: Any type
- Page size: 10 × 12 inches (254.0×304.8 mm)-Borderless
- Paper: Roll
- Paper type: Heavyweight Coated Paper
- Roll width: 10 inches (254.0 mm)

1. Select the printer in **Chooser**.
2. Choose **Page Setup** from the application menu to display the **Page Attribute** dialog box.

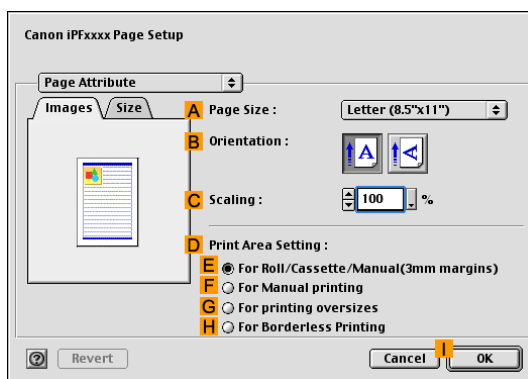

3. In **D Print Area Setting**, click **H For Broderless Printing**.
4. In the **A Page Size** list, choose a paper size supported for borderless printing. Here, click **10"x12" - Borderless**.



Note

- Paper sizes supported for borderless printing are indicated by “-Borderless.”

5. Click **I OK** to close the dialog box.
6. In the application, create an original that takes up the entire space of the paper size.
7. Choose **Print** in the application menu.

8. Make sure the **Main** pane is displayed.

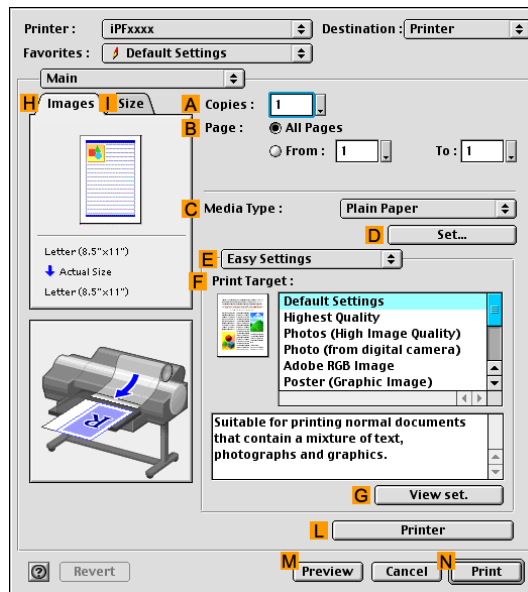

9. In the **C Media Type** list, select the type of paper that is loaded. In this case, click Heavyweight Coated Paper.

10. Select the print target in the **F Print Target** list.

11. Access the **Finishing** pane.

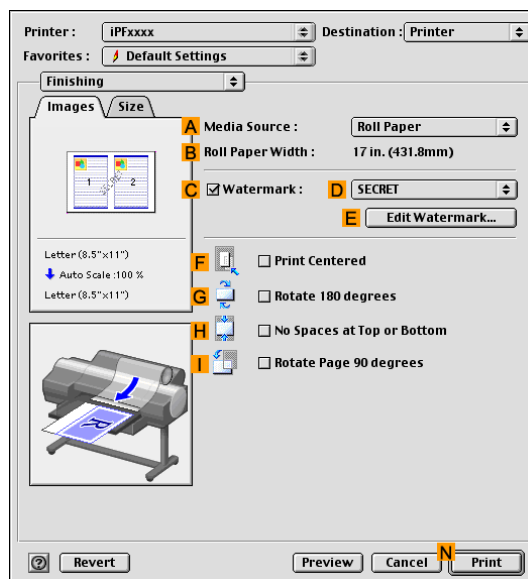

12. Click **Roll Paper** in the **A Media Source** list.

13. Confirm that the roll paper width matches the paper size.

Make sure the width of the loaded roll is displayed in the **B Roll Paper Width** list-in this case, **10 in. (254.0mm)**.



Note

- If the width of the loaded roll is not displayed in **B Roll Paper Width**, click **L Printer** on the **Main** pane and update the printer information.

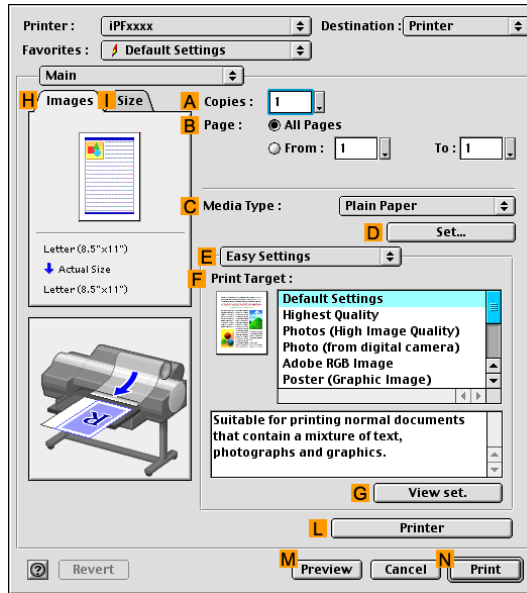

14. Access the **Page Setup** pane.

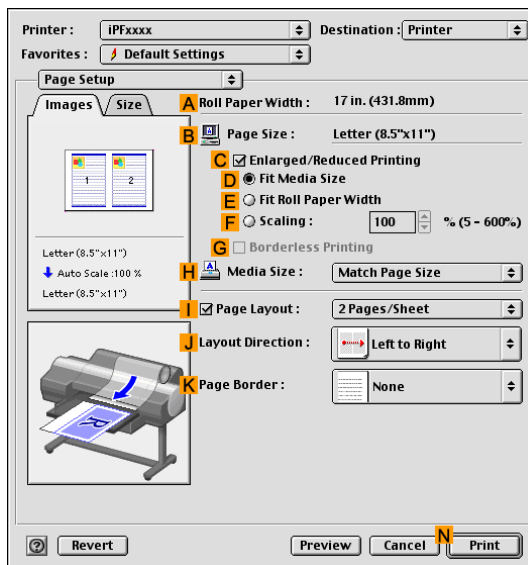

15. Make sure the **B Page Size** setting matches the original size as selected in **A Page Size** in the **Page Attribute** dialog box-in this case, **10"x12"**.

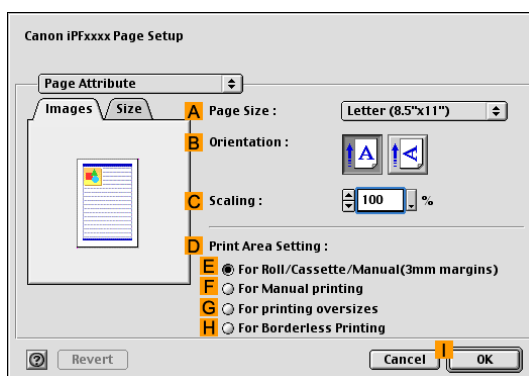

16. Confirm the print settings, and click **N Print** to start printing.



Note

- For tips on confirming print settings, see “Confirming Print Settings (Mac OS 9)”. (→P.518)

Borderless Printing by Resizing Originals to Fit the Roll Width (Windows)

This topic describes how to enlarge originals before borderless printing to match the roll width, based on the following example.

If you use n A1 or A2 roll for borderless printing, insert the provided Spacer for Borderless Printing on the Roll Holder. (→P.144)

If you do not attach the Spacer for Borderless Printing, the Platen may be soiled from borderless printing.

- Document: Any type
- Page size: A4 (210.0×297.0 mm)/Letter (8.3 × 11.7 in)
- Paper: Roll
- Paper type: Heavyweight Coated Paper
- Roll paper width: 10 inches (254.0 mm)

1. In the application, create an original that takes up the entire space of the paper size.



Note

- If you can specify the margin, as in Microsoft Word, set the margin at 0 mm. For instructions on specifying the margin, refer to the software documentation.

2. Choose **Print** in the application menu.

3. Select the printer in the dialog box, and then display the printer driver dialog box. (→P.473)

4. Make sure the **Main** sheet is displayed.

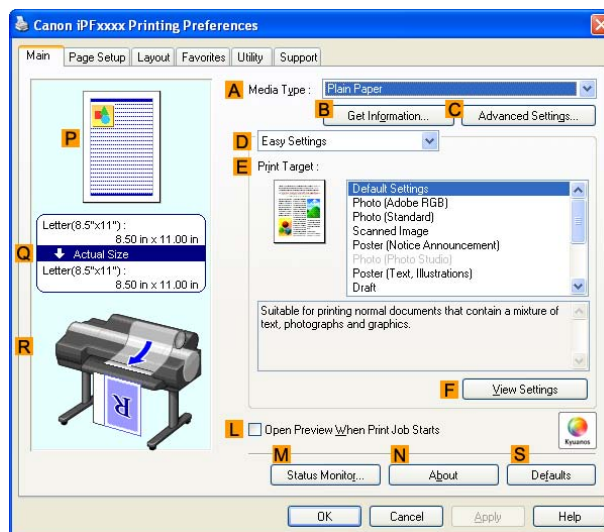

5. In the **A Media Type** list, select the type of paper that is loaded. In this case, click Heavyweight Coated Paper.

6. Select the print target in the **E Print Target** list.

7. Click the **Page Setup** tab to display the **Page Setup** sheet.

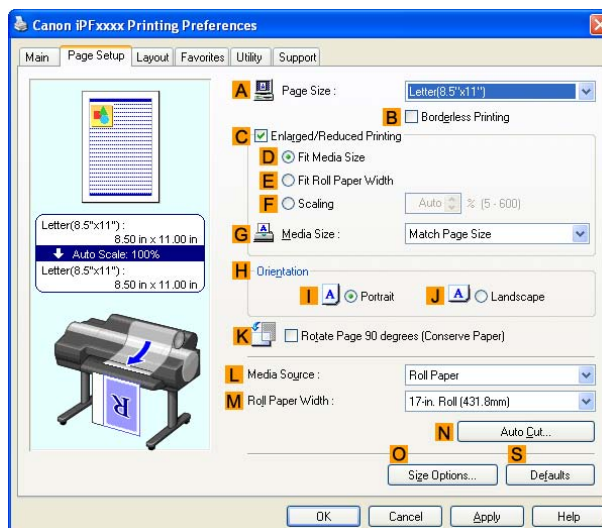

8. In the **A Page Size** list, click the size of the original as specified in the application. In this case, click **ISO A4** or **Letter (8.5"x11")**.

9. Click **Roll Paper** in the **L Media Source** list.

10. Select the **B Borderless Printing** check box to display the **Information** dialog box.

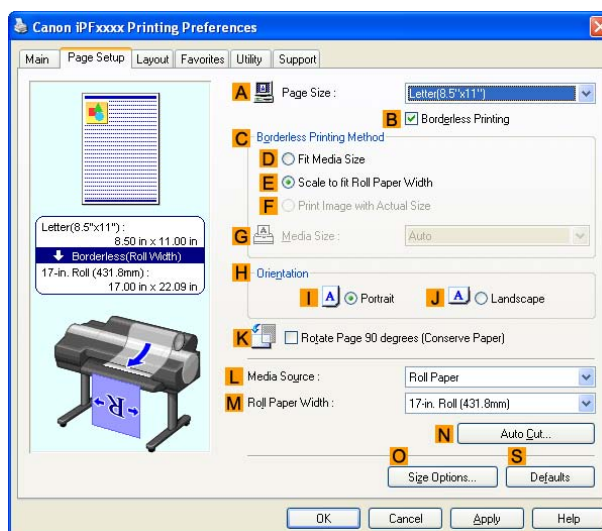

11. Select the width of the loaded roll in the **Roll Paper Width** list-in this case, click **10-in. Roll (254.0mm)**.

12. Click **OK** to close the **Information** dialog box.

13. In **C Borderless Printing Method**, make sure **E Scale to fit Roll Paper Width** is selected.

14. Confirm the print settings and print as desired.



Note

- For tips on confirming print settings, see “Confirming Print Settings (Windows)”. (→P.443)

Borderless Printing by Resizing Originals to Fit the Roll Width (Mac OS X)

This topic describes how to enlarge originals before printing to match the roll width, based on the following example. If you use an A1 or A2 roll for borderless printing, insert the provided Spacer for Borderless Printing on the Roll Holder. (→P.144)

If you do not attach the Spacer for Borderless Printing, the Platen may be soiled from borderless printing.

- Document: Any type
- Page size: A4 (210.0×297.0 mm)/Letter (8.3 × 11.7 in)
- Paper: Roll
- Paper type: Heavyweight Coated Paper
- Roll paper width: 10 inches (254.0 mm)

1. Choose **Page Setup** from the application menu to display the **Page Attribute** dialog box.

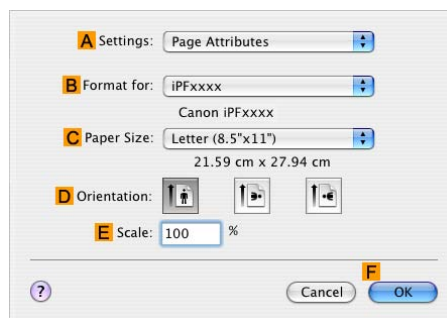

2. Select the printer in the **B Format for** list.

3. In **C Paper Size**, click the size of the original. In this case, click **ISO A4**.



Note

- All sizes are available in borderless printing if you resize originals to fit the roll width.

4. Click **F OK** to close the dialog box.

5. In the application, create an original that takes up the entire space of the paper size.

6. Choose **Print** in the application menu.

7. Access the **Main** pane.

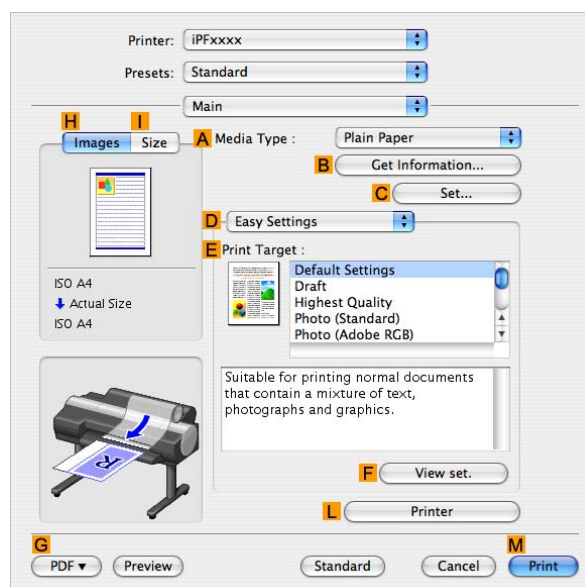

8. In the **A Media Type** list, select the type of paper that is loaded. In this case, click Heavyweight Coated Paper.
9. Select the print target in the **E Print Target** list.
10. Access the **Page Setup** pane.

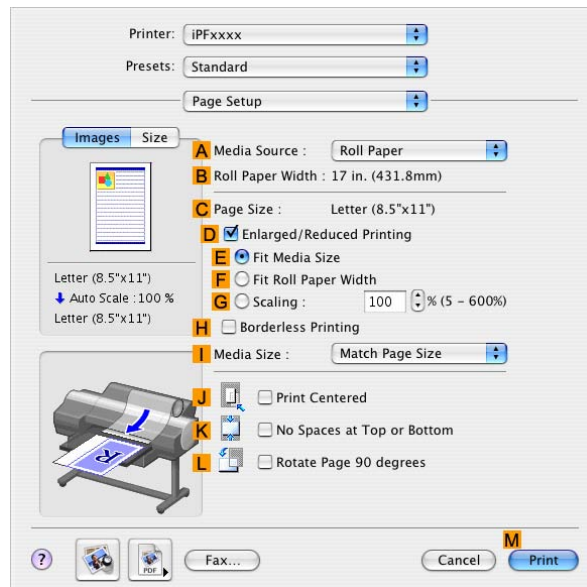

11. Click **Roll Paper** in the **A Media Source** list.
12. Make sure the width of the loaded roll is displayed in the **B Roll Paper Width** list—here, **10 in. (254.0mm)**.



Note

- If the width of the loaded roll is not displayed in **B Roll Paper Width**, click **L Printer Information** on the **Main** pane and update the printer information.

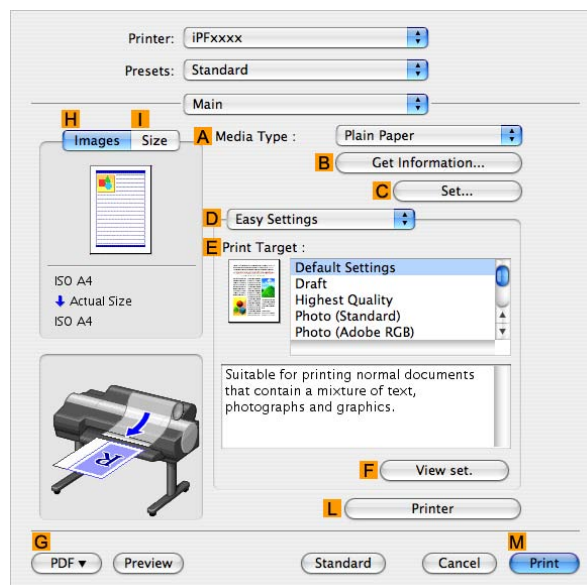

13. Make sure the **C Page Size** setting matches the original size as selected in **C Paper Size** in the **Page Attribute** dialog box-in this case, **ISO A4**.

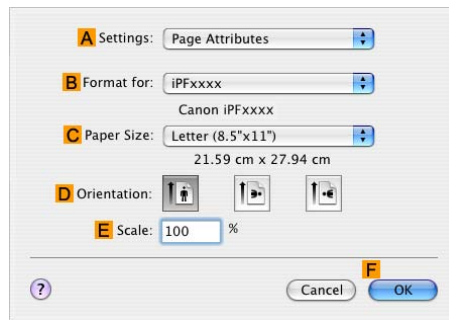

14. Select the **D Enlarged/Reduced Printing** check box.
15. Select the **H Borderless Printing** check box.
This ensures that **F Fit Roll Paper Width** is automatically selected in **D Enlarged/Reduced Printing**.
16. Confirm the print settings, and then click **M Print** to start printing.



Note

- For tips on confirming print settings, see “Confirming Print Settings (Mac OS X)”. (→P.493)

Borderless Printing by Resizing Originals to Fit the Roll Width (Mac OS 9)

This topic describes how to enlarge originals before printing to match the roll width, based on the following example. If you use an A1 or A2 roll for borderless printing, insert the provided Spacer for Borderless Printing on the Roll Holder. (→P.144)

If you do not attach the Spacer for Borderless Printing, the Platen may be soiled from borderless printing.

- Document: Any type
- Page size: A4 (210.0×297.0 mm)/Letter (8.3 × 11.7 in)
- Paper: Roll
- Paper type: Heavyweight Coated Paper
- Roll width: 10 inches (254.0 mm)

1. Select the printer in **Chooser**.
2. Choose **Page Setup** from the application menu to display the **Page Attribute** dialog box.

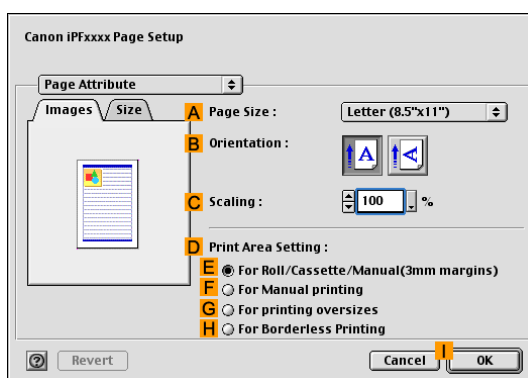

3. In **A Page Size**, click the size of the original. In this case, click **ISO A4**.



Note

- All sizes are available in borderless printing if you resize originals to fit the roll width.

4. Click **I OK** to close the dialog box.
5. In the application, create an original that takes up the entire space of the paper size.
6. Choose **Print** in the application menu.

7. Make sure the **Main** pane is displayed.

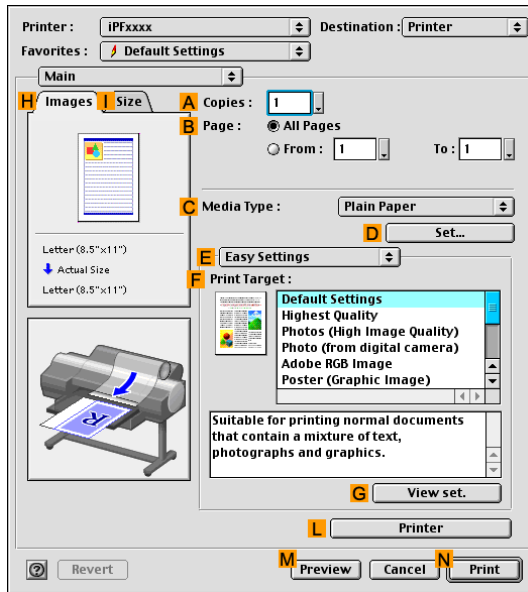

8. In the **C Media Type** list, select the type of paper that is loaded. In this case, click Heavyweight Coated Paper.

9. Select the print target in the **F Print Target** list.

10. Access the **Finishing** pane.

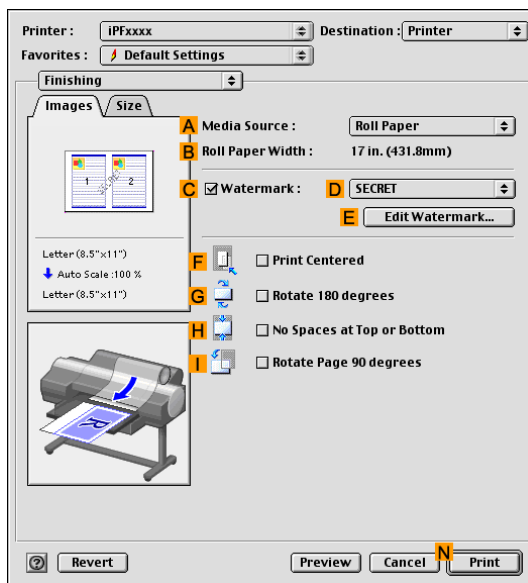

11. Click **Roll Paper** in the **A Media Source** list.

- Make sure the width of the loaded roll is displayed in the **B Roll Paper Width** list-in this case, **10 in. (254.0mm)**.



Note

- If the width of the loaded roll is not displayed in **B Roll Paper Width**, click **L Printer** on the **Main** pane and update the printer information.

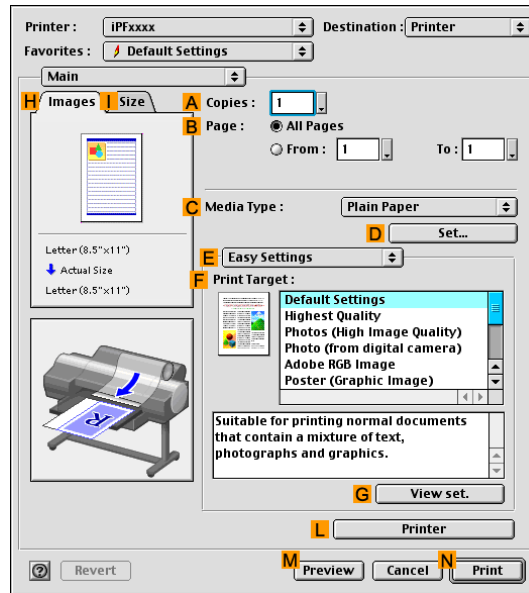

- Access the **Page Setup** pane.

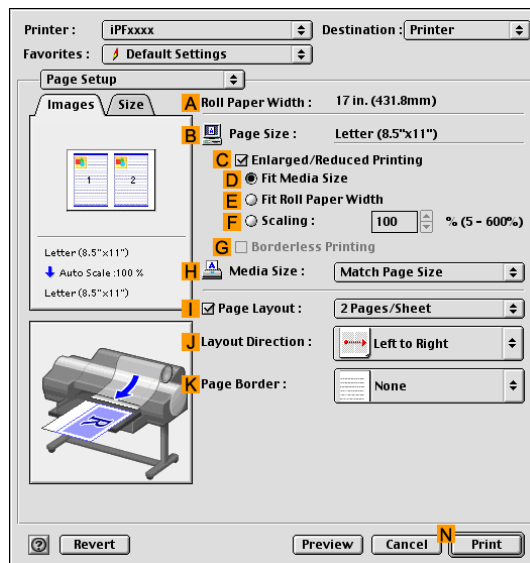

14. Make sure the **B Page Size** setting matches the original size as selected in **A Page Size** in the **Page Attribute** dialog box-in this case, **ISO A4**.

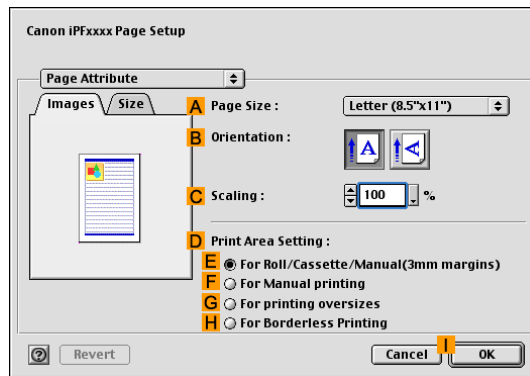

15. Select the **C Enlarged/Reduced Printing** check box.
16. Select the **G Borderless Printing** check box.
This ensures that **E Fit Roll Paper Width** is automatically selected in **C Enlarged/Reduced Printing**.
17. Confirm the print settings, and click **N Print** to start printing.



Note

- For tips on confirming print settings, see “Confirming Print Settings (Mac OS 9)”. (→P.518)

Borderless Printing by Resizing Originals to Match the Paper Size (Windows)

This topic describes how to enlarge originals before borderless printing to match the paper size, based on the following example.

If you use an A1 or A2 roll for borderless printing, insert the provided Spacer for Borderless Printing on the Roll Holder. (→P.144)

If you do not attach the Spacer for Borderless Printing, the Platen may be soiled from borderless printing.

- Document: Any type
- Page size: 10×12 inches (254.0×304.8 mm)
- Paper: Roll
- Paper type: Heavyweight Coated Paper
- Roll paper width: 10 inches (254.0 mm)

1. In the application, create an original that takes up the entire space of the paper size.



Note

- If you can specify the margin, as in Microsoft Word, set the margin at 0 mm. For instructions on specifying the margin, refer to the software documentation.

2. Choose **Print** in the application menu.

3. Select the printer in the dialog box, and then display the printer driver dialog box. (→P.473)

4. Make sure the **Main** sheet is displayed.

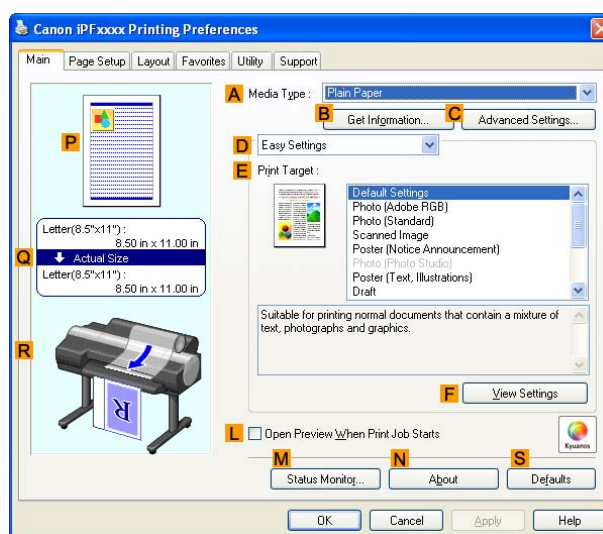

5. In the **A Media Type** list, select the type of paper that is loaded. In this case, click Heavyweight Coated Paper.

6. Select the print target in the **E Print Target** list.

7. Click the **Page Setup** tab to display the **Page Setup** sheet.

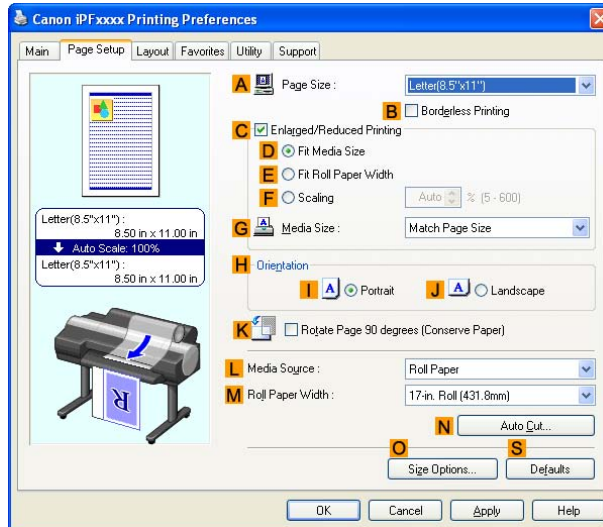

8. In the **A Page Size** list, click the size of the original as specified in the application. In this case, click **10"x12"**.

9. Click **Roll Paper** in the **L Media Source** list.

10. Select the **B Borderless Printing** check box to display the **Information** dialog box.

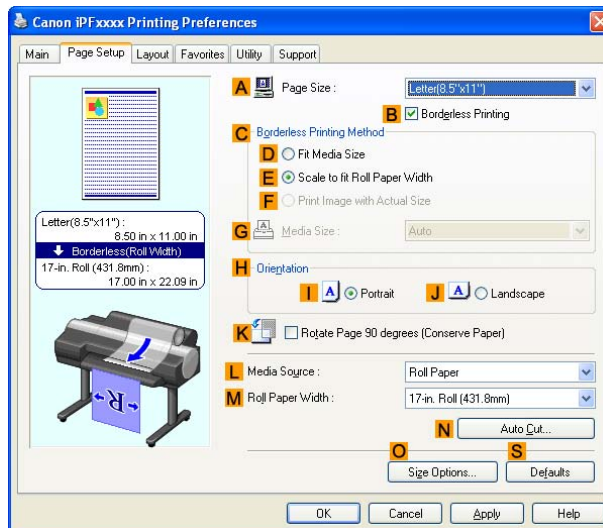

11. Select the width of the loaded roll in the **Roll Paper Width** list-in this case, click **10-in. Roll (254.0mm)**.

12. Click **OK** to close the **Information** dialog box.

13. In **C Borderless Printing Method**, click **D Fit Media Size**.

14. Click **Match Page Size** in the **G Media Size** list.

15. Confirm the print settings and print as desired.



Note

- For tips on confirming print settings, see “Confirming Print Settings (Windows)”. (→P.443)

Borderless Printing by Resizing Originals to Match the Paper Size (Mac OS X)

This topic describes how to enlarge originals before borderless printing to match the paper size, based on the following example.

If you use an A1 or A2 roll for borderless printing, insert the provided Spacer for Borderless Printing on the Roll Holder. (→P.144)

If you do not attach the Spacer for Borderless Printing, the Platen may be soiled from borderless printing.

- Document: Any type
- Page size: 10×12 inches (254.0×304.8 mm)
- Paper: Roll
- Paper type: Heavyweight Coated Paper
- Roll paper width: 10 inches (254.0 mm)

1. Choose **Page Setup** from the application menu to display the **Page Attribute** dialog box.

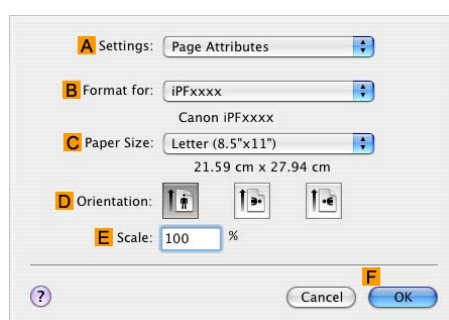

2. Select the printer in the **B Format for** list.

3. In the **C Paper Size** list, click the size of the original. In this case, click **10"×12"**.



Note

- All sizes are available in borderless printing if you resize originals to match the paper size.

4. Click **F OK** to close the dialog box.

5. In the application, create an original that takes up the entire space of the paper size.

6. Choose **Print** in the application menu.

7. Access the **Main** pane.

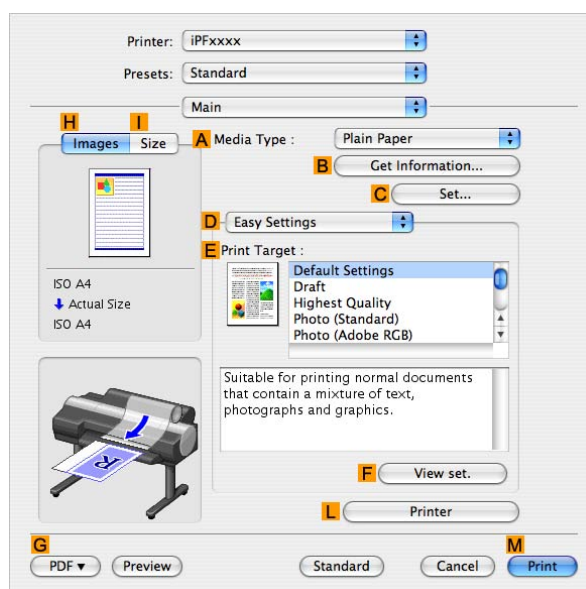

8. In the **A Media Type** list, select the type of paper that is loaded. In this case, click Heavyweight Coated Paper.
9. Select the print target in the **E Print Target** list.
10. Access the **Page Setup** pane.

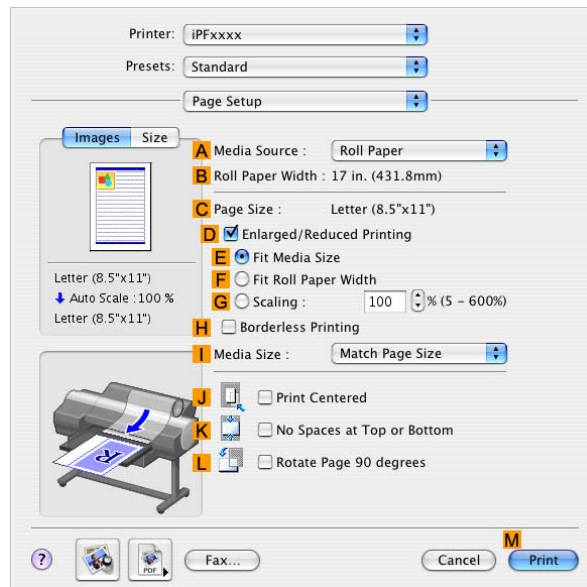

11. Click **Roll Paper** in the **A Media Source** list.
12. Make sure the width of the loaded roll is displayed in the **B Roll Paper Width** list-in this case, **10 in. (254.0mm)**.



Note

- If the width of the loaded roll is not displayed in **B Roll Paper Width**, click **L Printer Information** on the **Main** pane and update the printer information.

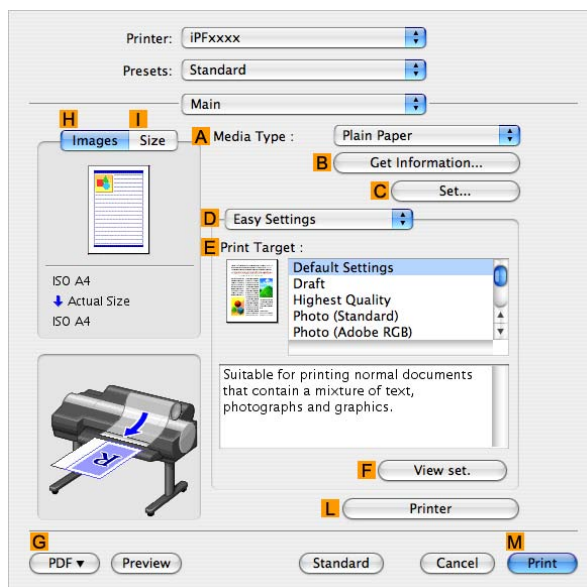

13. Make sure the **C Page Size** setting matches the original size as selected in **C Paper Size** in the **Page Attribute** dialog box-in this case, **10"x12"**.

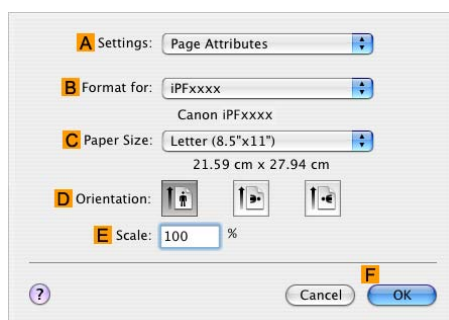

14. Select the **D Enlarged/Reduced Printing** check box.
15. Select the **H Borderless Printing** check box.
16. Click **E Fit Media Size** under **D Enlarged/Reduced Printing**.
17. In **I Media Size**, click the paper size. In this case, click **10"x12" - Borderless**.
18. Confirm the print settings, and then click **M Print** to start printing.



Note

- For tips on confirming print settings, see “Confirming Print Settings (Mac OS X)”. (→P.493)

Borderless Printing by Resizing Originals to Match the Paper Size (Mac OS 9)

This topic describes how to enlarge originals before borderless printing to match the paper size, based on the following example.

If you use an A1 or A2 roll for borderless printing, insert the provided Spacer for Borderless Printing on the Roll Holder. (→P.144)

If you do not attach the Spacer for Borderless Printing, the Platen may be soiled from borderless printing.

- Document: Any type
- Page size: 10×12 inches (254.0×304.8 mm)
- Paper: Roll
- Paper type: Heavyweight Coated Paper
- Roll width: 10 inches (254.0 mm)

1. Select the printer in **Chooser**.
2. Choose **Page Setup** from the application menu to display the **Page Attribute** dialog box.

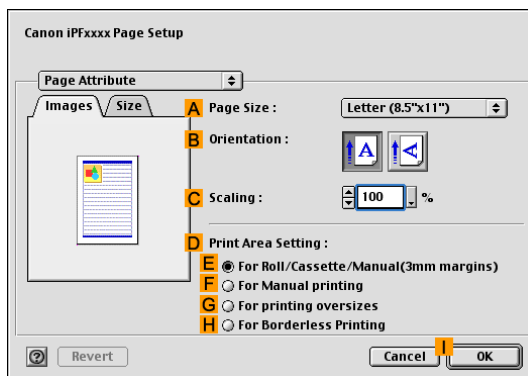

3. In the **A Page Size** list, click the size of the original. In this case, click **10"x12"**.



Note

- All sizes are available in borderless printing if you resize originals to match the paper size.

4. Click **I OK** to close the dialog box.
5. In the application, create an original that takes up the entire space of the paper size.
6. Choose **Print** in the application menu.

7. Make sure the **Main** pane is displayed.

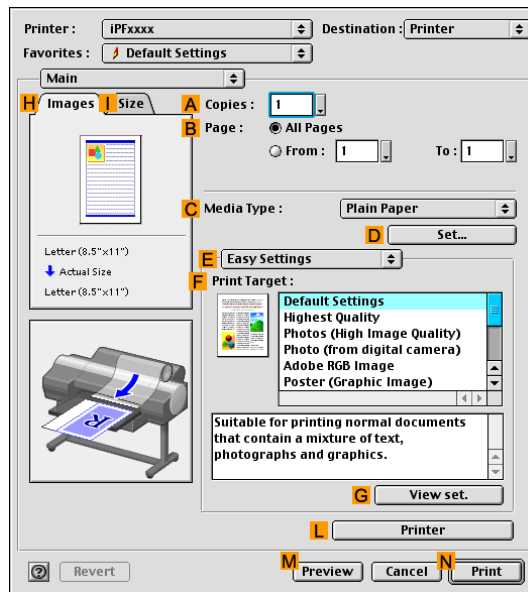

8. In the **C Media Type** list, select the type of paper that is loaded. In this case, click Heavyweight Coated Paper.

9. Select the print target in the **F Print Target** list.

10. Access the **Finishing** pane.

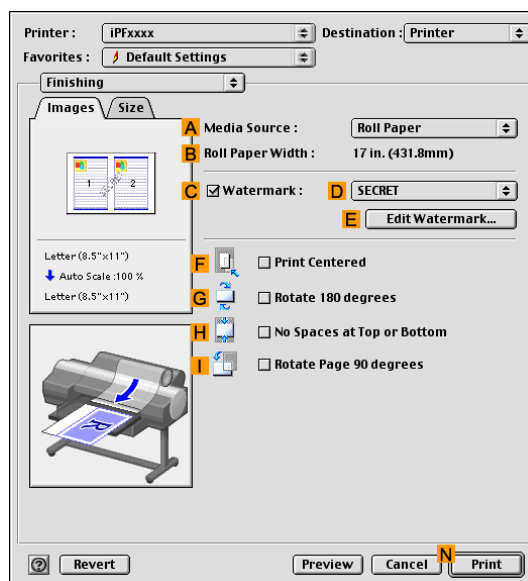

11. Click **Roll Paper** in the **A Media Source** list.

12. Make sure the width of the loaded roll is displayed in the **B Roll Paper Width** list-in this case, **10 in. (254.0mm)**.



Note

- If the width of the loaded roll is not displayed in **B Roll Paper Width**, click **L Printer** on the **Main** pane and update the printer information.

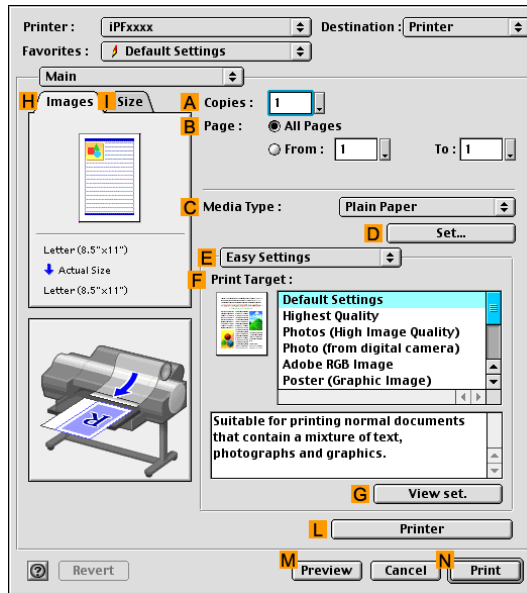

13. Access the **Page Setup** pane.

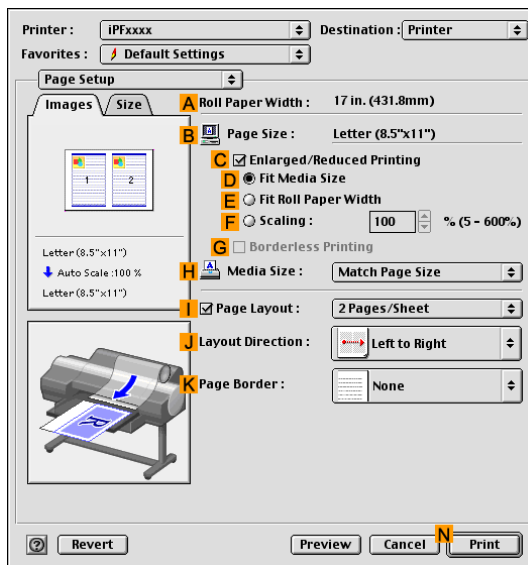

14. Make sure the **B Page Size** setting matches the original size as selected in **A Page Size** in the **Page Attribute** dialog box-in this case, **10"x12"**.

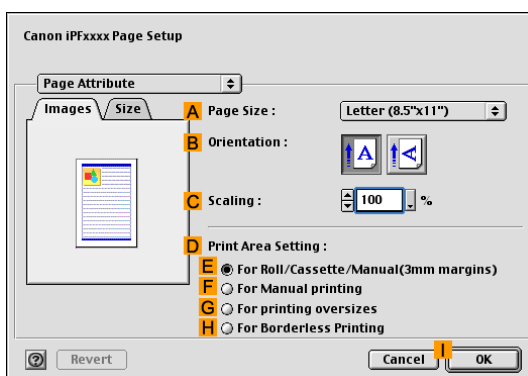

15. Select the **C Enlarged/Reduced Printing** check box.
 16. Select the **G Borderless Printing** check box.
 17. Click **D Fit Media Size** under **C Enlarged/Reduced Printing**.
 18. In **H Media Size**, click the paper size. In this case, click **10"x12" - Borderless**.
 19. Confirm the print settings, and click **N Print** to start printing.



Note

- For tips on confirming print settings, see "Confirming Print Settings (Mac OS 9)". (→P.518)

Printing banners or at other non-standard sizes

Printing Vertical or Horizontal Banners (Large-Format Printing)

You can create vertical or horizontal banners by printing originals that are in banner format on rolls. Originals created in Microsoft Word or other applications in your preferred size can be enlarged to fill the width of roll paper by completing simple printer driver settings.

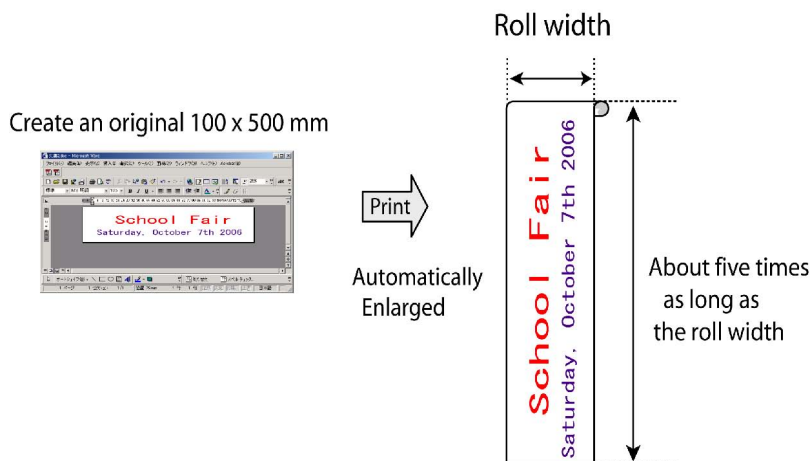

Fit Roll Paper Width

You can easily create vertical or horizontal banners by automatically enlarging or reducing originals to fit the full width of rolls.



Note

- The maximum supported roll length is 18.0 m or 19.7 yd (when printing in Mac OS X).

For instructions on printing vertical or horizontal banners, refer to the following topics, as appropriate for your computer and operating system.

- Printing Vertical or Horizontal Banners (Large-Format Printing; Windows) (→P.341)
- Printing Vertical or Horizontal Banners (Large-Format Printing; Mac OS X) (→P.345)
- Printing Vertical or Horizontal Banners (Large-Format Printing; Mac OS 9) (→P.348)



Important

- Before printing, check how much of the roll paper is left. If you have activated automatic detection of the remaining roll paper, a warning message is displayed when there is not enough roll paper left.
- If not much ink is left, prepare replacement ink tanks.
- To print at a higher level of quality, in the printer driver, choose **High** or **Highest** in Print Quality, and choose **Unidirectional Printing** as the direction of printing.

Printing on Non-Standard Paper Sizes

By specifying the paper size, you can print on non-standard sizes of paper. There are two ways to print on non-standard paper sizes, as follows.

Registering non-standard paper size in the printer driver

After you register non-standard paper sizes, they are listed with standard sizes so that you can choose them anytime as needed.



Note

- These non-standard paper sizes you register in the printer driver are called **Custom Media Size** in Windows and Mac OS 9. In Mac OS X, they are called “Custom Sizes.”

Specifying custom media sizes for temporary use

Because these are sizes you specify temporarily in the printer driver, the sizes will not be available after you exit the application. If you want to set up a non-standard paper size so that it will always be available, we recommend registering the paper size in the printer driver.



Note

- These temporary paper sizes you register on the printer are called “Custom Sizes” in Windows.

For instructions on specifying non-standard paper sizes for printing, refer to the following topics, as appropriate for your computer and operating system.

- Printing on Non-Standard Paper Sizes (Windows) (→P.332)
- Printing on Non-Standard Paper Sizes (Mac OS X) (→P.336)
- Printing on Non-Standard Paper Sizes (Mac OS 9) (→P.338)

Printing on Non-Standard Paper Sizes (Windows)

This topic describes two ways to print on non-standard paper sizes.

- Printing by using **Custom Size** (→P.332)
- Printing by using **Custom Media Size** (→P.334)

Printing by using Custom Size

This section describes how to print using **Custom Size** based on the following example.

- Document: Scanned image
- Page size: Square of non-standard dimensions (430×430 mm [16.9×16.9 in])
- Paper: Sheets (**Manual**)
- Paper type: Plain Paper
- Paper size: A square sheet (430×430 mm [16.9×16.9 in])

1. Load the square paper (430×430 mm [16.9×16.9 in]) in the Top Paper Feed Slot.
2. Choose **Print** in the source application menu.
3. Select the printer in the dialog box, and then display the printer driver dialog box. (→P.473)
4. Make sure the **Main** sheet is displayed.

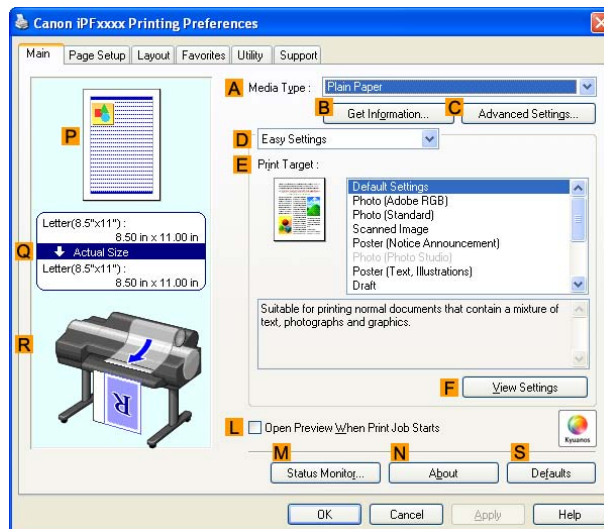

5. In the **A Media Type** list, select the type of paper that is loaded. In this case, click Plain Paper.
6. After confirming that **D Easy Settings** is selected, click **Scanned Image** in the **E Print Target** list.

7. Click the **Page Setup** tab to display the **Page Setup** sheet.

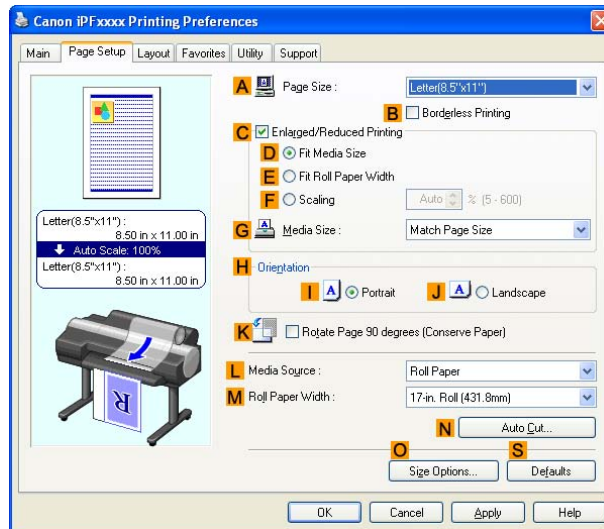

8. Click **Manual** in the **L Media Source** list.
9. Click **Custom Size** in the **A Page Size** list to display the **Custom Size Settings** dialog box.
10. Complete the following settings in the **Custom Size Settings** dialog box.
 1. Select **mm** or **inch** in **Units**.
 2. Enter “430” [16.9 in] in both **Width** and **Height**.
11. Click **OK** to close the **Custom Size Settings** dialog box.
12. Confirm the print settings and print as desired.



Note

- For instructions on confirming print settings, see “Confirming Print Settings (Windows)”. (→P.443)

Printing by using Custom Media Size

This section describes how to print using **Custom Media Size** based on the following example. First, register a non-standard paper size called “430 mm Square” as a **Custom Media Size**.

- Document: Scanned image
- Page size: A square sheet (430×430 mm [16.9×16.9 in])
- Paper: Sheets (**Manual**)
- Paper type: Plain Paper
- Paper size: A square sheet (430×430 mm [16.9×16.9 in])

1. Load the square paper (430×430 mm [16.9×16.9 in]) in the Top Paper Feed Slot.
2. Choose **Print** in the source application menu.
3. Select the printer in the dialog box, and then display the printer driver dialog box. (→P.473)
4. Make sure the **Main** sheet is displayed.

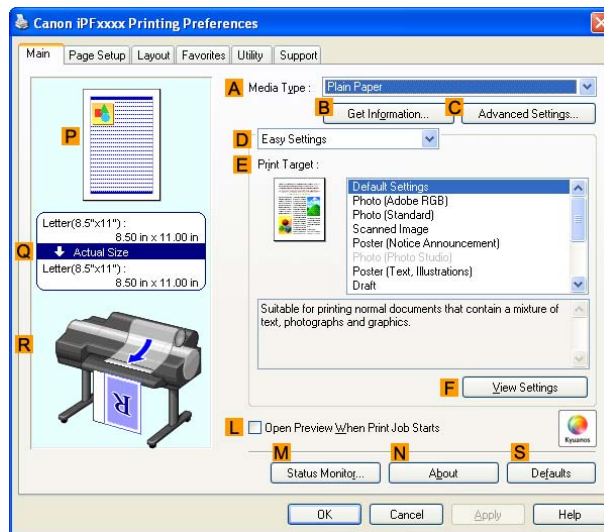

5. In the **A Media Type** list, select the type of paper that is loaded. In this case, click Plain Paper.
6. After confirming that **D Easy Settings** is selected, click **Scanned Image** in the **E Print Target** list.

7. Click the **Page Setup** tab to display the **Page Setup** sheet.

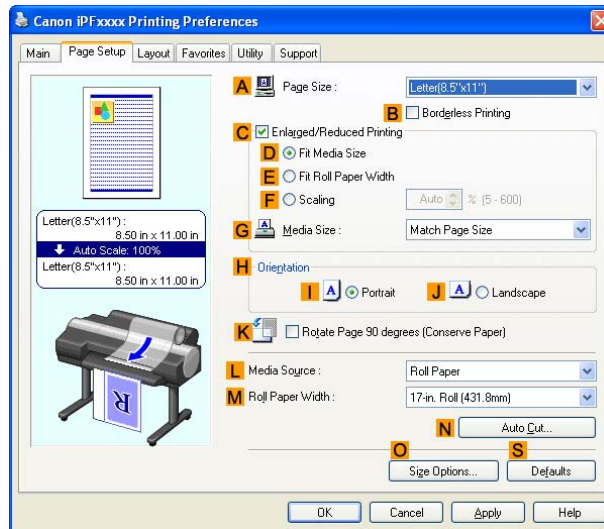

8. Click **O Size Options** to display the **Media Size Options** dialog box.

9. Complete the following settings in the **Media Size Options** dialog box.

1. Enter a desired paper name in **Custom Media Size Name**. "430 mm Square" is used in this example.
2. Select **mm** or **inch** in **Units**.
3. Enter "430" [16.9 in] in both **Width** and **Height**.



Note

- If you select the **Fix the Ratio of the Width to Height** check box, after you enter a value in either **Width** or **Height**, the other value will be automatically applied based on the original aspect ratio.

10. Click **Add** to register "430 mm Square."

11. Click **OK** to close the **Media Size Options** dialog box.

12. Click **Manual** in the **L Media Source** list.

13. In the **A Page Size** list, click the size you added, "430 mm Square."

14. Confirm the print settings and print as desired.



Note

- For instructions on confirming print settings, see "Confirming Print Settings (Windows)". (→P.443)

Printing on Non-Standard Paper Sizes (Mac OS X)

This topic describes how to print after registering “Custom Media Size” based on the following example. Here, you will register a non-standard paper size named “430*430” in “Custom Media Size”.

- Document: Scanned image
- Page size: A square sheet (430×430 mm [16.9×16.9 in])
- Paper: Sheets (**Manual**)
- Paper type: Plain Paper
- Paper size: A square sheet (430×430 mm [16.9×16.9 in])



Note

- The following procedures are based on Mac OS X 10.4. The method of setting up non-standard paper sizes varies depending on the version of Mac OS X.

1. Create the document in the application.
2. Load the square paper (430×430 mm [16.9×16.9 in]) in the Top Paper Feed Slot.
3. Choose **Page Setup** from the application menu to display the **Page Attribute** dialog box.

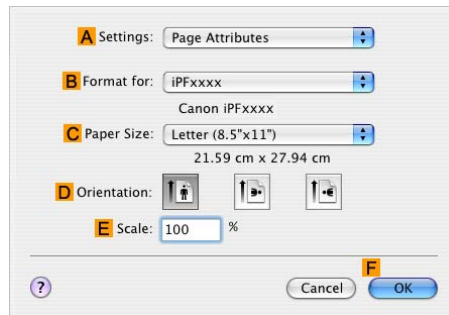

4. Select the printer in the **B Format for** list.
5. Click **Manage Custom Sizes** in the **C Paper Size** list to display the **Custom Page Sizes** dialog box.
6. In **Page Size**, enter the height and width of the original. Here, enter “43.00 cm” in **Height** and **Width**.
7. In **Printer Margins**, enter “0.3” for the top and side margins and “2.3” for the bottom margin. Here, measurements are entered in centimeters.
8. Double-click **Untitled** in the list at left in the **Custom Page Sizes** dialog box and enter the paper name-in this case, “430*430”.
9. Click **OK** to close the **Custom Page Sizes** dialog box.
10. In the **C Paper Size** list, click the size of the original. In this case, click “430*430”, the size you registered.
11. Click **OK** to close the dialog box.
12. Choose **Print** in the application menu.

13. Access the **Main** pane.

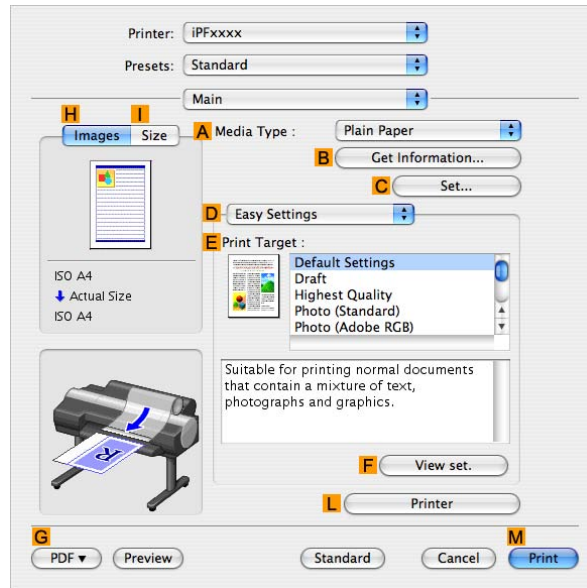

14. In the **A Media Type** list, select the type of paper that is loaded. In this case, click Plain Paper.

15. After confirming that **D Easy Settings** is selected, click **Scanned Image** in the **E Print Target** list.

16. Access the **Page Setup** pane.

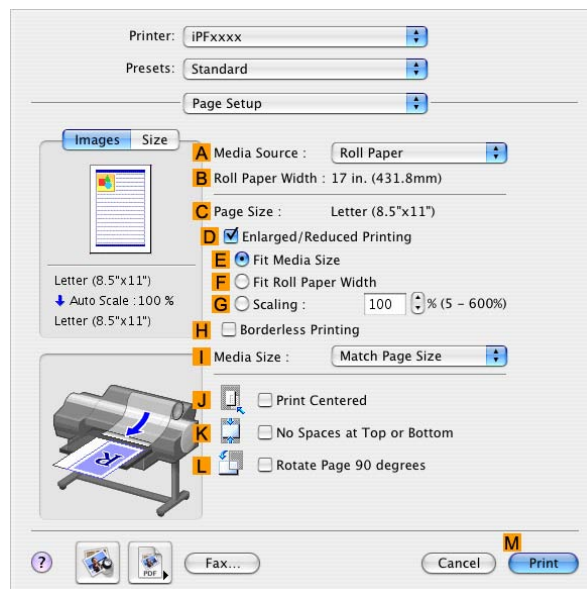

17. Click **Manual** in the **A Media Source** list.

18. In **D Easy Settings**, make sure “430*430” is displayed, as registered in **Page Setup**.

19. Confirm the print settings, and then click **M Print** to start printing.



Note

- For tips on confirming print settings, see “Confirming Print Settings (Mac OS X)”. (→P.493)

Printing on Non-Standard Paper Sizes (Mac OS 9)

This topic describes how to print using **Custom Media Size** based on the following example. Here, you will register a non-standard paper size named “430*430” in **Custom Media Size**.

- Document: Scanned image
- Page size: A square sheet (430×430 mm [16.9×16.9 in])
- Paper: Sheets (**Manual**)
- Paper type: Plain Paper
- Paper size: A square sheet (430×430 mm [16.9×16.9 in])

1. Create the document in the application.
2. Load the square paper (430×430 mm [16.9×16.9 in]) in the Top Paper Feed Slot.
3. Select the printer in **Chooser**.
4. Choose **Page Setup** in the application menu to display the **Page Attribute** dialog box.

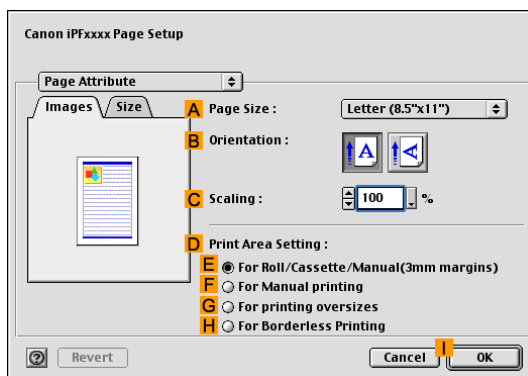

5. Click **Media Design** in the **Page Attribute** list to display the **Media Design** pane.

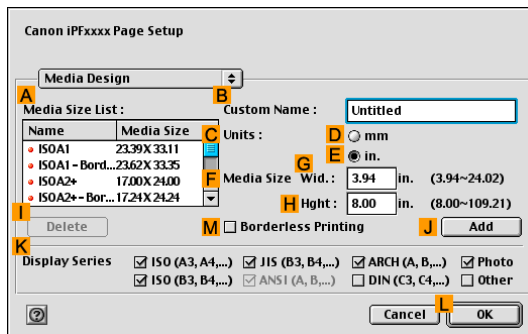

6. Enter a paper name of your choice in **B Custom Name**. “430*430” is used in this example.
7. In **F Media Size**, enter the height and width of the original. Here, enter “430” in **H Hght** and **G Wid.**
8. Click **J Add** to add the paper size named “430*430”.

9. Access the **Page Attribute** dialog box.

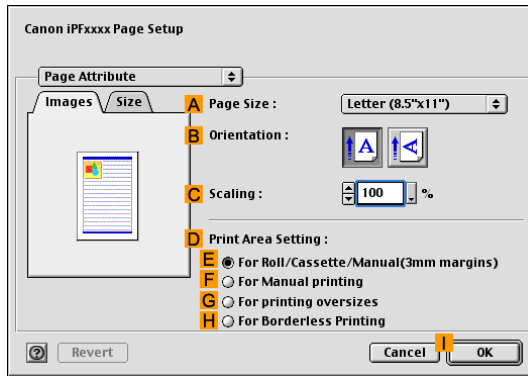

10. In the **A Page Size** list, click the size of the original. In this case, click “430*430”, the size you registered.
11. In **D Print Area Setting**, click **F For Manual printing**.
12. Click **I OK** to close the dialog box.
13. Choose **Print** in the application menu.
14. Make sure the **Main** pane is displayed.

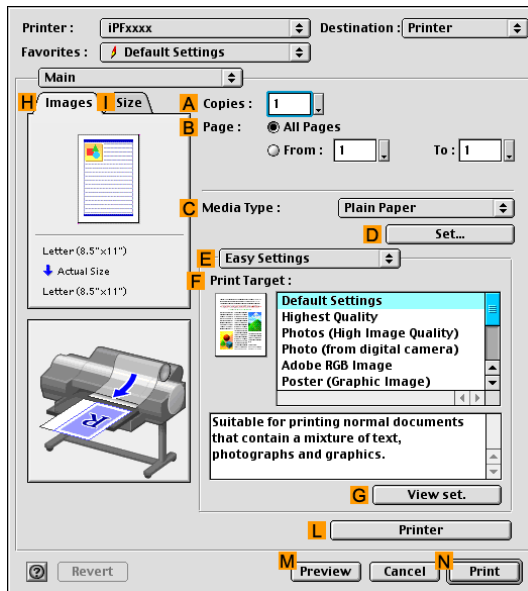

15. In the **C Media Type** list, select the type of paper that is loaded. In this case, click Plain Paper.
16. After confirming that **E Easy Settings** is selected, click **Scanned Image** in the **F Print Target** list.

17. Access the **Finishing** pane.

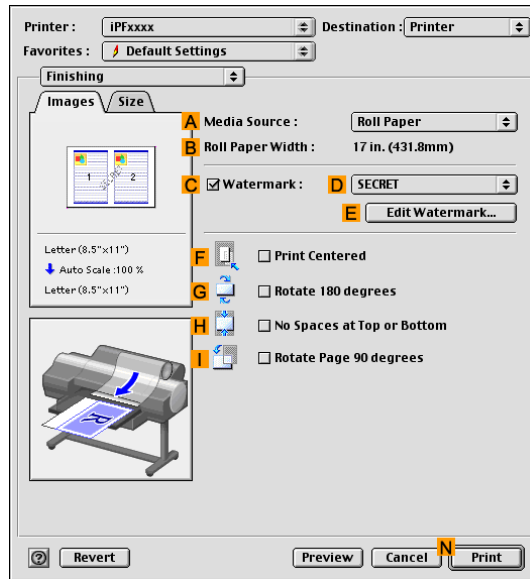

18. Click **Manual** in the **A Media Source** list.

19. Confirm the print settings, and then click **N Print** to start printing.



Note

- For tips on confirming print settings, see “Confirming Print Settings (Mac OS 9)”. (→P.518)

Printing Vertical or Horizontal Banners (Large-Format Printing; Windows)

This topic describes how to print a banner about five times as long as the roll width based on the following example.

- Document: A horizontal banner created in Microsoft Word
- Page size: Non-standard (100×500 mm [3.9×19.7 in])
- Paper: Roll
- Paper type: Plain Paper
- Roll paper width: 16 in (406.4 mm)

Follow the steps below to print a banner in either horizontal or vertical format.

1. Register a **Custom Media Size**.

Banners tend to be in non-standard sizes, so register a **Custom Media Size**. In this example, 100×500 mm (3.9×19.7 in) is registered.

2. In the application, create an original in the size you registered.
3. Print the banner, using the settings that correspond to banners.

Registering a Custom Media Size

This example describes how to register a paper size that is horizontally elongated and suitable for banners in either horizontal or vertical format.

1. Display the printer driver dialog box. (→P.149)
2. Click the **Page Setup** tab to display the **Page Setup** sheet.

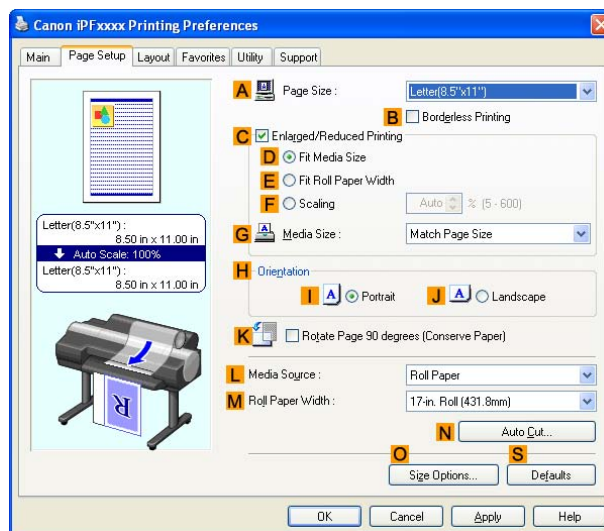

3. Click **Roll Paper** in the **L Media Source** list.
4. Click **O Size Options** to display the **Media Size Options** dialog box.
5. Enter a desired paper name in **Custom Media Size Name**. “My Horizontal Banner” is used in this example.
6. In **Units**, click **mm**.
7. Under **Media Size**, enter “100” in **Width** and “500” in **Height**.
8. Click **Add** to add the paper size of “My Horizontal Banner.”
9. Click **OK** to close the **Media Size Options** dialog box.

10. Close the printer driver dialog box.



Note

- You can also specify a **Custom Size** as the paper size. Note that **Custom Size** settings are not available after you exit the application.
For more information, see “Printing on Non-Standard Paper Sizes (Windows)”. (→P.332)

Creating the banner in the application

Follow the steps below to create the banner in Microsoft Word using the **Custom Media Size** you registered.

1. Start Microsoft Word.
2. Choose **Page Setup** from the **File** menu to display the **Page Setup** dialog box.
3. Under **Paper Size**, click the **Custom Media Size** you registered-"My Horizontal Banner" in this example.



Important

- If "My Horizontal Banner" is not listed, make sure this printer is selected as the printer to use.
 - In applications such as Microsoft PowerPoint that do not enable you to choose registered paper sizes, use the custom paper size setting in “Custom” and specify 100×500 mm (3.9×19.7 in)
4. Set the printing orientation to horizontal
 5. Create the banner.

Printing the banner

Follow the steps below to print the banner using the corresponding banner settings.

1. Choose **Print** in the Microsoft Word menu.
2. Select the printer in the dialog box, and then open the printer driver dialog box. (→P.473)
3. Make sure the **Main** sheet is displayed.

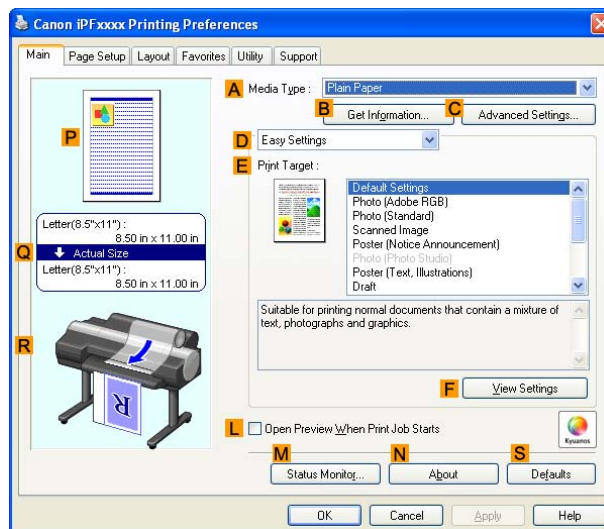

4. In the **A Media Type** list, select the type of paper that is loaded. In this case, click Plain Paper.
5. After confirming that **D Easy Settings** is selected, click **POP Ad** in the **E Print Target** list.
6. Click the **Page Setup** tab to display the **Page Setup** sheet.

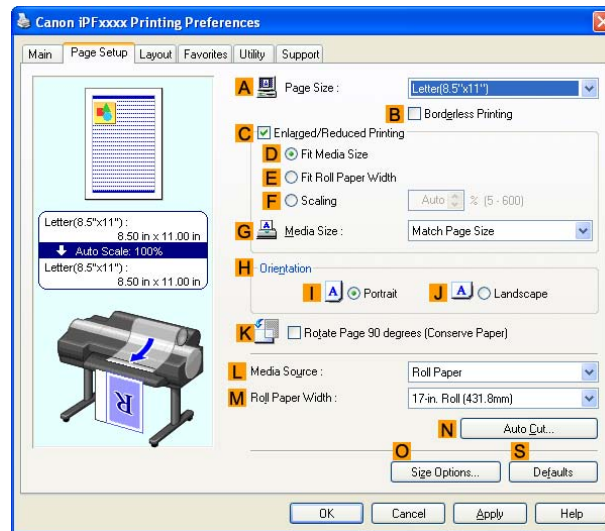

7. In the **A Page Size** list, click the size you registered, "My Horizontal Banner."
8. Select the **C Enlarged/Reduced Printing** check box.



Note

- If the **Enlarged/Reduced Printing** check box is not displayed on the **Page Setup** sheet, clear the **B Borderless Printing** check box.

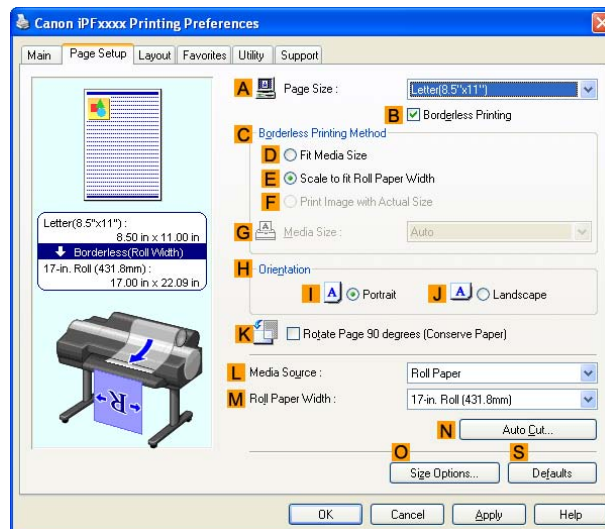

9. Click **Roll Paper** in the **L Media Source** list.
10. After you click **E Fit Roll Paper Width**, the **Information** dialog box is displayed.
11. Select the width of the loaded roll in the **Roll Paper Width** list. In this case, click **16-in. Roll (406.4mm)**, and then click **OK**.
12. Confirm the print settings and print as desired.



Note

- For instructions on confirming print settings, see “Confirming Print Settings (Windows)”. (→P.443)



Note

- If printing is unsuccessful, you may be able to print after completing the following setting.
 1. On the **Layout** sheet, click **M Special Settings** to display the **Special Settings** dialog box.

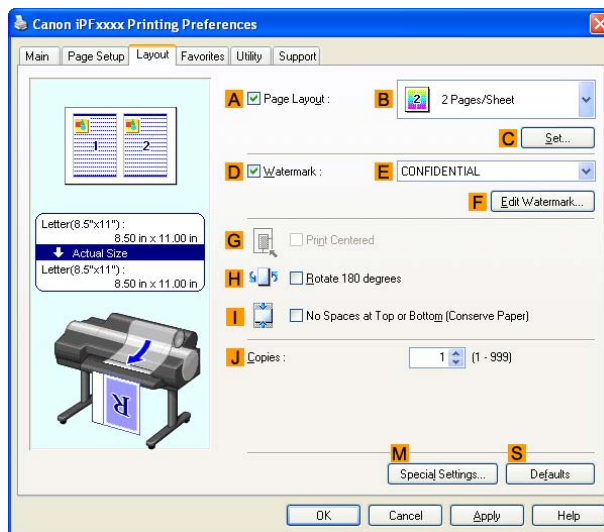

2. In the **FineZoom Settings** list, click **Yes**.

Printing Vertical or Horizontal Banners (Large-Format Printing; Mac OS X)

This topic describes how to print a banner about five times as long as the roll width based on the following example.

- Document: An original designed for a horizontal banner
- Page Size: Non-standard (100×500 mm [3.9×19.7 in])
- Paper: Roll
- Paper type: Plain Paper
- Roll paper width: 16 inches (406.4 mm)

Follow the steps below to print a banner in either horizontal or vertical format.

1. In the application, create an original in the format of a horizontal or vertical banner.
2. Register a “Custom Page Size.”
Banners tend to be in non-standard sizes, so register a “Custom Page Size” in **Page Setup**. In this example, 100×500 mm (3.9×19.7 in) is registered.
3. Print the banner, using the settings that correspond to banners.



Note

- The following procedures are based on Mac OS X 10.4. The method of setting up non-standard paper sizes varies depending on the version of Mac OS X.

Register a Custom Page Size

This example describes how to register and print using a page size that is horizontally elongated and suitable for banners in either horizontal or vertical format.

1. Create the document in the application.
2. Choose **Page Setup** from the application menu to display the **Page Attribute** dialog box.

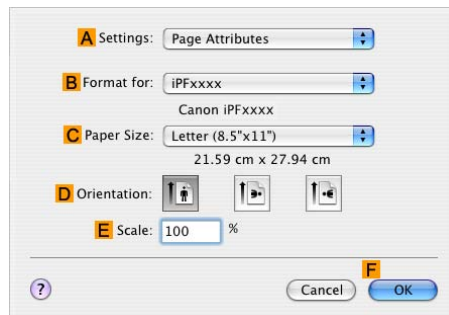

3. Select the printer in the **B Format for** list.
4. Click **Manage Custom Sizes** in the **C Paper Size** list to display the **Custom Page Sizes** dialog box.
5. Double-click **Untitled** in the list at left, and then enter a name for the page size you want to register. Here, enter “100*500.”
If the **Untitled** size is not listed at left, click **+** below the list.
6. Under **Page Size**, enter “10” in **Width** and “50” in **Height**. Here, measurements are entered in centimeters.
7. Specify the margins by entering “0.3” in **Printer Margins**. Here, too, measurements are entered in centimeters.

Printing banners or at other non-standard sizes

8. Click **OK** to close the **Custom Page Sizes** dialog box.
9. In the **C Paper Size** list, click the size of the original. In this case, click "100*500", the size you registered.
10. In **D Orientation**, click the icon of the document in landscape orientation.
11. Click **F OK** to close the dialog box.

Print the banner

Follow the steps below to print the banner using the corresponding banner settings.

1. Choose **Print** in the application menu.
2. Access the **Main** pane.

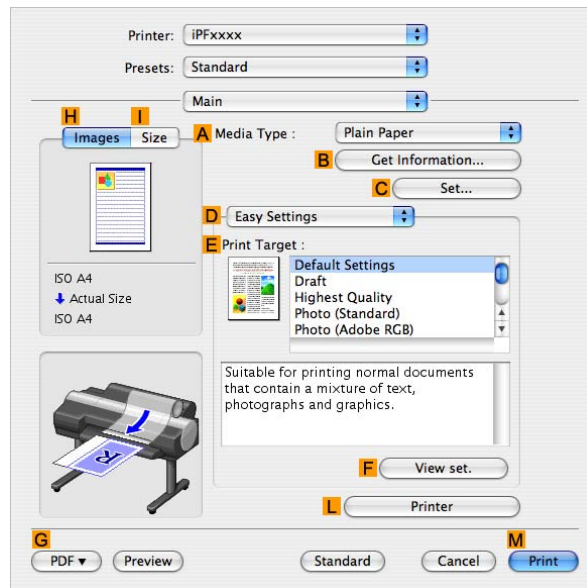

3. In the **A Media Type** list, select the type of paper that is loaded. In this case, click Plain Paper.
4. After confirming that **D Easy Settings** is selected, click **POP** in the **E Print Target** list.
5. Access the **Page Setup** pane.

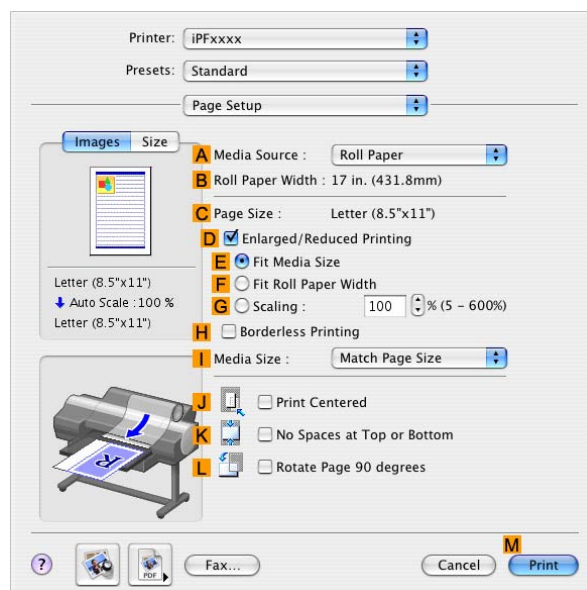

6. Click **Roll Paper** in the **A Media Source** list.
7. Make sure the width of the loaded roll is displayed in the **B Roll Paper Width** list-in this case, **16 in. (406.4mm)**.



Note

- If the width of the loaded roll is not displayed in **B Roll Paper Width**, click **L Printer Information** on the **Main** pane and update the printer information.

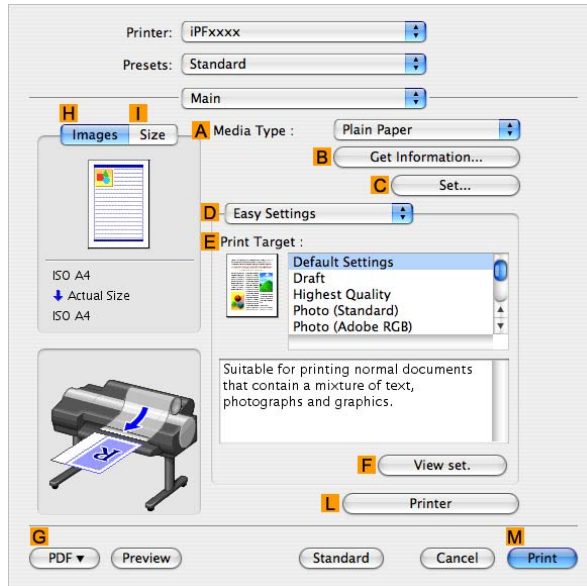

8. In **C Page Size**, make sure "100*500" is displayed, as registered in **Page Setup**.
9. Select the **D Enlarged/Reduced Printing** check box.
10. Click **F Fit Roll Paper Width**.
11. Confirm the print settings, and click **M Print** to start printing.



Note

- For tips on confirming print settings, see "Confirming Print Settings (Mac OS X)". (→P.493)

Printing Vertical or Horizontal Banners (Large-Format Printing; Mac OS 9)

This topic describes how to print a banner about five times as long as the roll width based on the following example.

- Document: An original designed for a horizontal banner
- Page size: Non-standard (100×500 mm, [3.9×19.7 in])
- Paper: Roll
- Paper type: Plain Paper
- Roll paper width: 10 inches (254.0 mm)

The steps to print a vertical or horizontal banner are as follows.

1. In the application, create an original in the format of a horizontal or vertical banner.
2. Register a **Custom Media Size** in **Media Design**.
Banners tend to be in non-standard sizes, so register a **Custom Media Size**. In this example, 100×500 mm (3.9×19.7 in) is registered.
3. Print the banner, using the settings that correspond to banners.

Register a Custom Media Size

This example describes how to register and print using a page size that is horizontally elongated and suitable for banners in either horizontal or vertical format.

1. Create the document in the application.
2. Select the printer in **Chooser**.
3. Choose **Page Setup** in the application menu to display the **Page Attribute** dialog box.

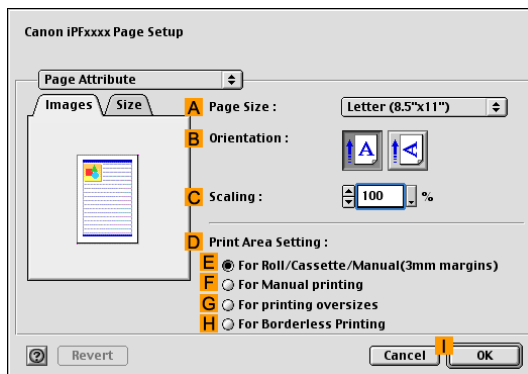

4. Click **Media Design** in the **Page Attribute** list to display the **Media Design** pane.

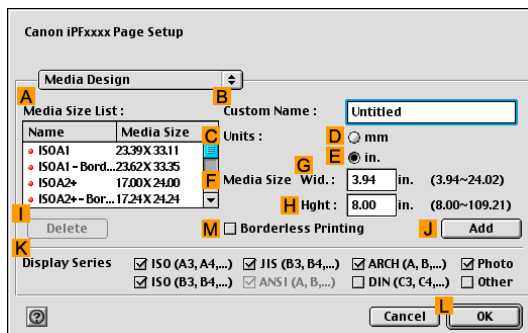

5. Enter a desired paper name in **B Custom Name**. “My Horizontal Banner” is used in this example.
6. In **C Units**, click **D mm**.
7. Under **F Media Size**, enter “100” in **G Wid.** and “500” in **H Hght.**
8. Click **J Add** to add the paper size of “My Horizontal Banner.”
9. Access the **Page Attribute** dialog box.

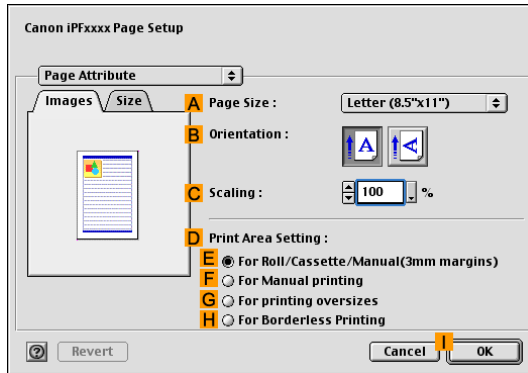

10. In the **A Page Size** list, click the size you added, “My Horizontal Banner.”
11. In **B Orientation**, click the icon of the document in landscape orientation.
12. Click **I OK** to close the dialog box.

Print the banner

Follow these steps to print the banner using the corresponding banner settings.

1. Choose **Print** in the application menu.
2. Make sure the **Main** pane is displayed.

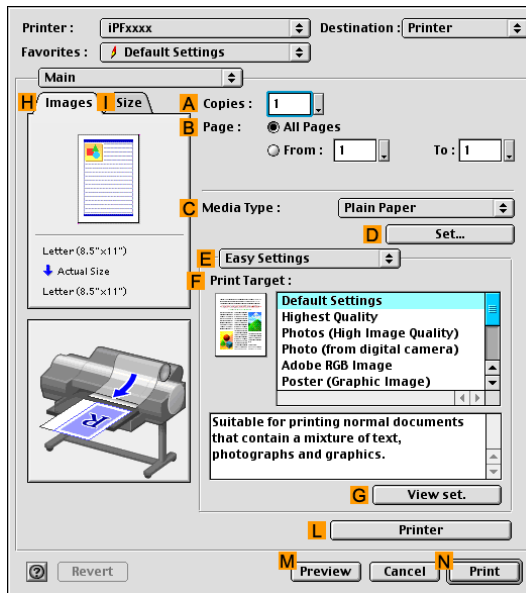

3. In the **C Media Type** list, select the type of paper that is loaded. In this case, click Plain Paper.
4. After confirming that **E Easy Settings** is selected, click **POP** in the **F Print Target** list.
5. Access the **Finishing** pane.

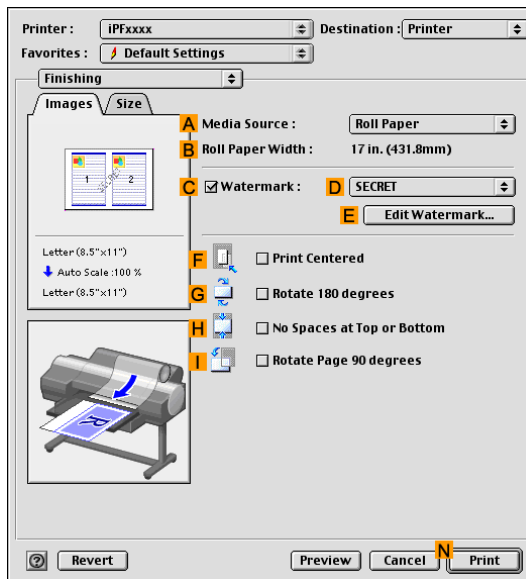

6. Click **Roll Paper** in the **A Media Source** list.
7. Make sure the width of the loaded roll is displayed in the **B Roll Paper Width** list—in this case, **10 in. (254.0mm)**.



Note

- If the width of the loaded roll is not displayed in **B Roll Paper Width**, click **L Printer** on the **Main** pane and update the printer information.

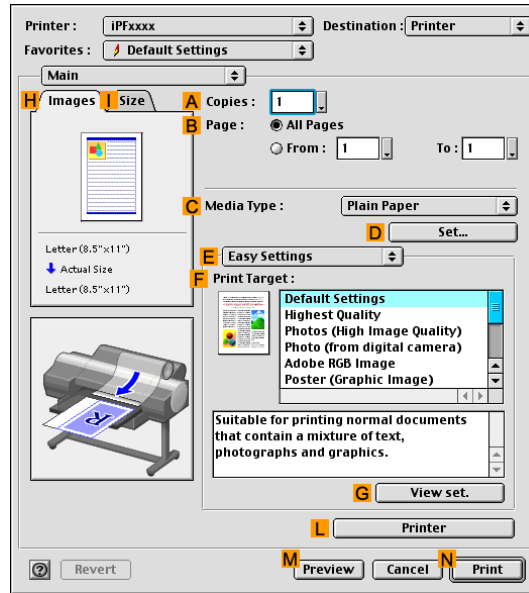

8. Access the **Page Setup** pane.

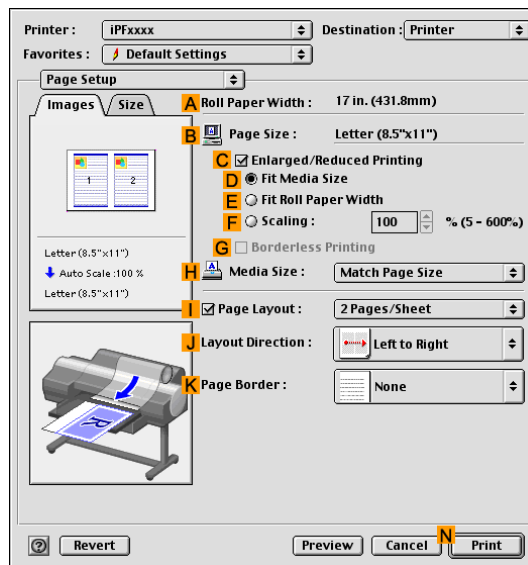

9. In **B Page Size**, make sure “My Horizontal Banner” is displayed, as registered in **Media Design**.
10. Select the **C Enlarged/Reduced Printing** check box.
11. Click **E Fit Roll Paper Width**.
12. Confirm the print settings, and then click **N Print** to start printing.



Note

- For tips on confirming print settings, see “Confirming Print Settings (Mac OS 9)”. (→P.518)

Tiling and multiple pages per sheet

Printing Multiple Originals Next to Each Other

By arranging originals from word-processing or spreadsheet programs or web browser screen shots next to each other on single sheets, you can create highly expressive presentation materials, easy-to-understand meeting materials, and a variety of other printed documents.

Free Layout (Windows)

Besides combining multiple pages in a single-page layout, you can combine originals from multiple files—even multiple source applications—in a single-page layout.

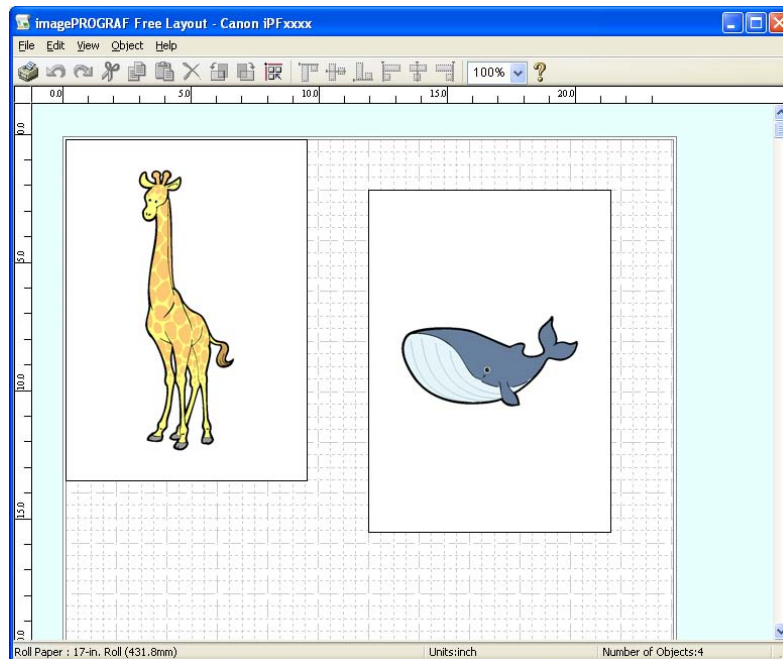

imagePROGRAF Free Layout (Macintosh)

Besides combining multiple pages in a single-page layout, you can combine originals from multiple files—even multiple source applications—in a single-page layout.

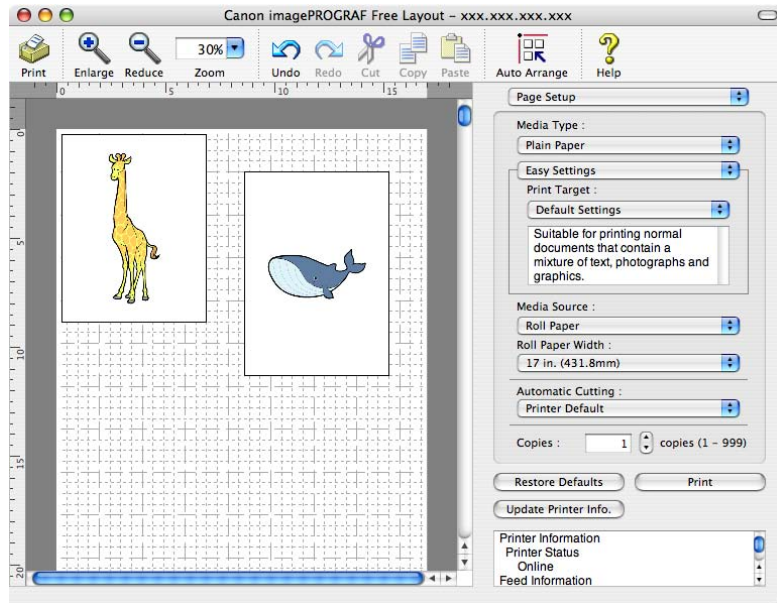

Important

- The driver must be installed from the User Software CD-ROM to use this function.

For instructions on arranging originals from multiple applications, refer to the following topics.

- Printing Multiple Originals Next to Each Other (Windows) (→P.361)
- Printing Multiple Originals Next to Each Other (Mac OS X) (→P.363)

Printing Multiple Pages Continuously

You can print multiple pages as a single continuous image, without margins between pages.

Roll paper (banner)

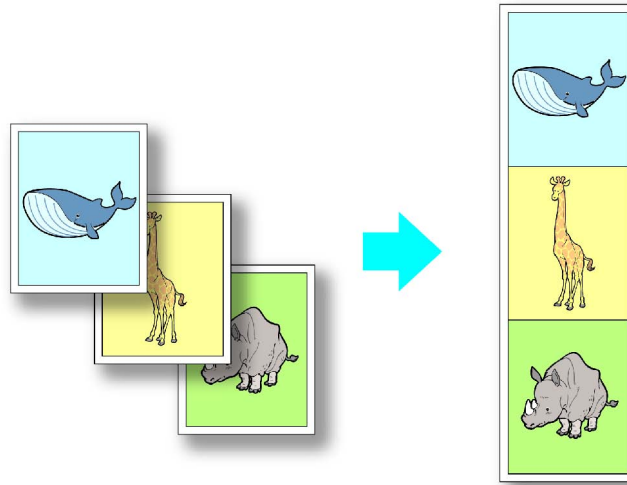

Important

- This feature is only available with rolls. It cannot be used when printing on sheets.
- During banner printing, settings for conserving paper, number of copies, borderless printing, enlargement or reduction, and other layout-related settings are disregarded.

For instructions on borderless printing of photos and images at actual size, refer to the following topics, as appropriate for your computer and operating system.

- Printing Multiple Pages Continuously (Windows) (→P.365)
- Printing Multiple Pages Continuously (Mac OS X) (→P.366)
- Printing Multiple Pages Continuously (Mac OS 9) (→P.368)

Printing Multiple Pages Per Sheet

To conserve paper, you can print several pages of the original on a single sheet by reducing the original and dividing the sheet into areas for each page.

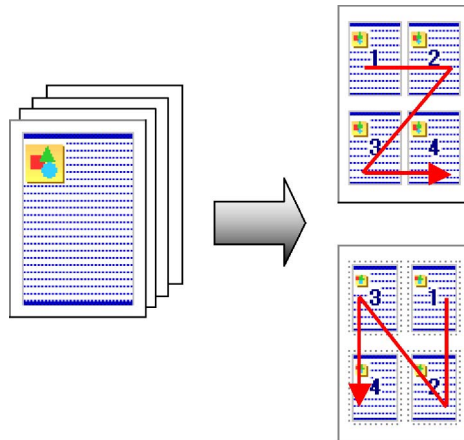

Page Layout

Specify a number of pages of the original to print on a single sheet, in a layout of multiple pages per sheet.



Note

- You can print up to 16 pages of the original on a single sheet.
- You can also change the page layout order and print page boundary lines, as desired.



Important

- This function cannot be combined with the following options.
 - Borderless Printing
 - Scaling Originals (Windows)
 - Banner Printing (Windows)

For instructions on printing multiple pages per sheet, refer to the following topics, as appropriate for your computer and operating system.

- Printing Multiple Pages Per Sheet (Windows) (→P.370)
- Printing Multiple Pages Per Sheet (Mac OS X) (→P.372)
- Printing Multiple Pages Per Sheet (Mac OS 9) (→P.375)

Printing Posters in Sections

You can enlarge an original to print it in sections on several sheets. By assembling the printed sheets, you can create a poster larger than the maximum supported paper size of the printer.

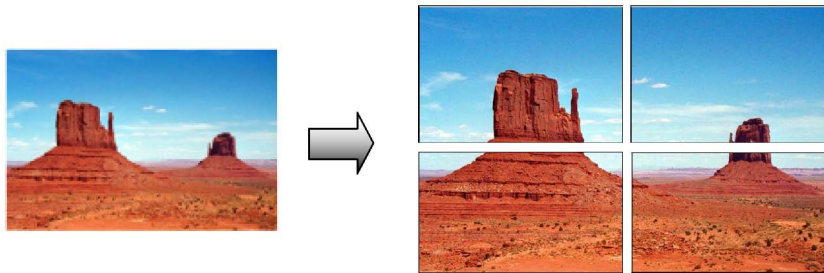

Page Layout

Choose poster printing.

For instructions on printing large posters, refer to the following topics, as appropriate for your computer and operating system.

- [Printing Large Posters \(Windows\) \(→P.357\)](#)
- [Printing Large Posters \(Mac OS 9\) \(→P.359\)](#)



Note

- This method of poster printing is supported in Windows and Mac OS 9.

Printing Large Posters (Windows)

You can enlarge an original to print it in sections on several sheets. By assembling the printed sheets, you can create a poster larger than the maximum supported paper size of the printer. This topic describes how to enlarge an A2 original for printing it in sections on four sheets, based on the following example.

- Document: Poster
- Page size: A2 (420.0×594.0 mm [16.5 × 23.4 in])
- Paper: Sheets (**Manual**)
- Paper Type: Glossy Paper
- Paper size: A2 (420.0×594.0 mm [16.5 × 23.4 in])

1. Choose **Print** in the application menu.
2. Select the printer in the dialog box, and then display the printer driver dialog box. (→P.473)
3. Make sure the **Main** sheet is displayed.

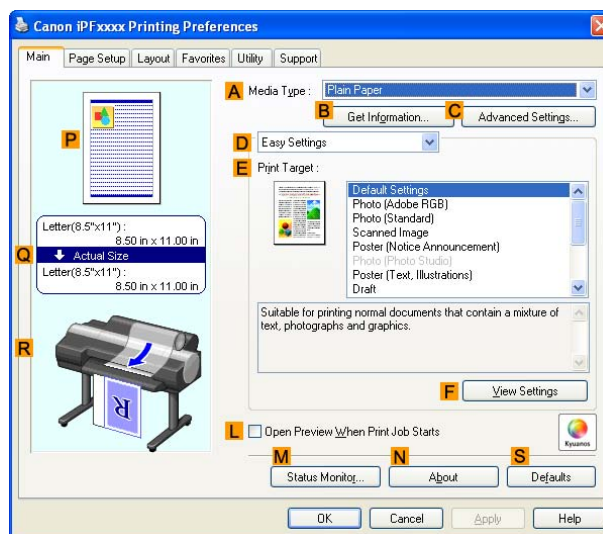

4. In the **A Media Type** list, select the type of paper that is loaded. In this case, click Glossy Paper.
5. Click **Poster (Graphic Image)** in the **E Print Target** list.
6. Click the **Page Setup** tab to display the **Page Setup** sheet.

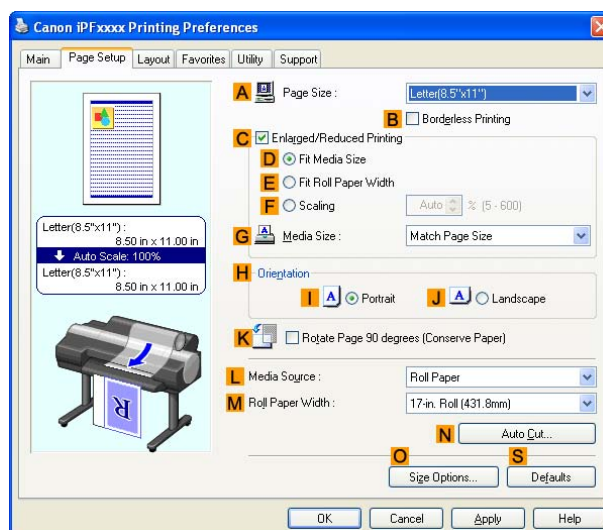

7. In **A Page Size**, click the size of the original as specified in the application. In this case, click **ISO A2**.
8. Click **Manual** in the **L Media Source** list.
9. Click the **Layout** tab to display the **Layout** sheet.

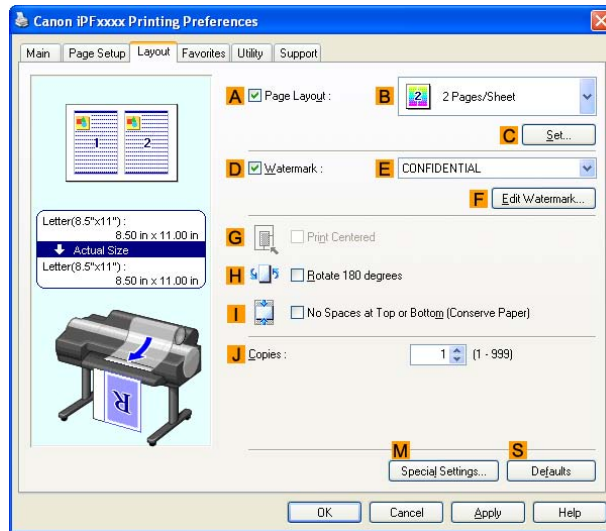

10. Select the **A Page Layout** check box.
11. Click **Poster (2 x 2)** in the **B Page Layout** list.



Note

- Follow the steps below to print only a portion of the poster as divided for printing.
 1. Click **C Set** under **B Page Layout** to display the **Pages to Print** dialog box.
 2. On the **Pages to Print** dialog box, clear the check boxes of the portion you do not want to print.
 3. Click **OK** to close the **Pages to Print** dialog box.

12. Confirm the print settings and print as desired.



Note

- For instructions on confirming print settings, see "Confirming Print Settings (Windows)". (→P.443)

Printing Large Posters (Mac OS 9)

You can enlarge an original to print it in sections on several sheets. By assembling the printed sheets, you can create a poster larger than the maximum supported paper size of the printer. This topic describes how to enlarge an A2 original for printing on four sheets of paper based on the following example.

- Document: Poster
- Page size: A2 (420.0×594.0 mm [16.5 × 23.4 in])
- Paper: Sheets (**Manual**)
- Paper type: Glossy Paper
- Paper size: A2 (420.0×594.0 mm [16.5 × 23.4 in])

1. Select the printer in **Chooser**.
2. Choose **Page Setup** from the application menu to display the **Page Attribute** dialog box.

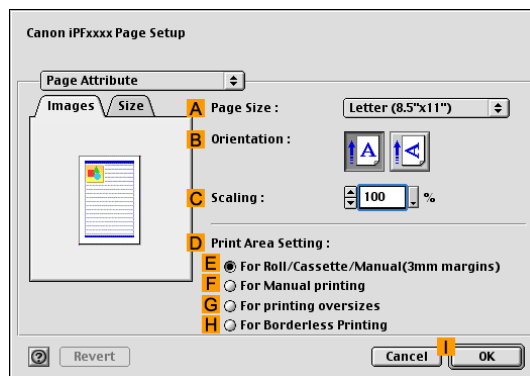

3. In the **A** Page Size list, click the size of the original. In this case, click **ISO A2**.
4. In **D** Print Area Setting, click **F** For Manual printing.
5. Click **I** OK to close the dialog box.
6. Choose **Print** in the application menu.
7. Make sure the **Main** pane is displayed.

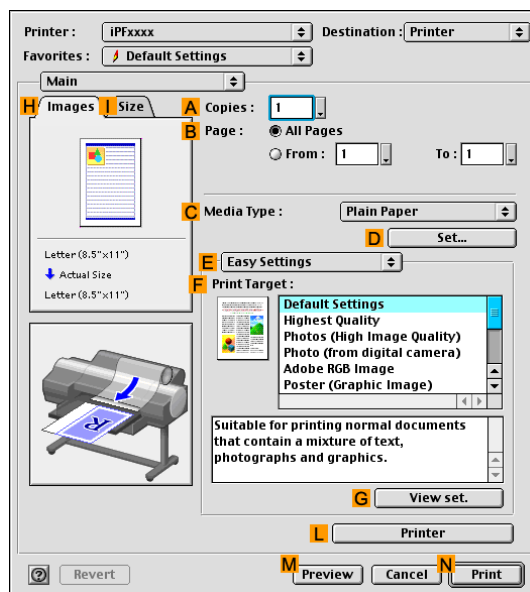

8. In the **C Media Type** list, select the type of paper that is loaded. In this case, click Glossy Paper.
9. After confirming that **E Easy Settings** is selected, click **Poster (Graphic Image)** in the **F Print Target** list.
10. Access the **Page Setup** pane.

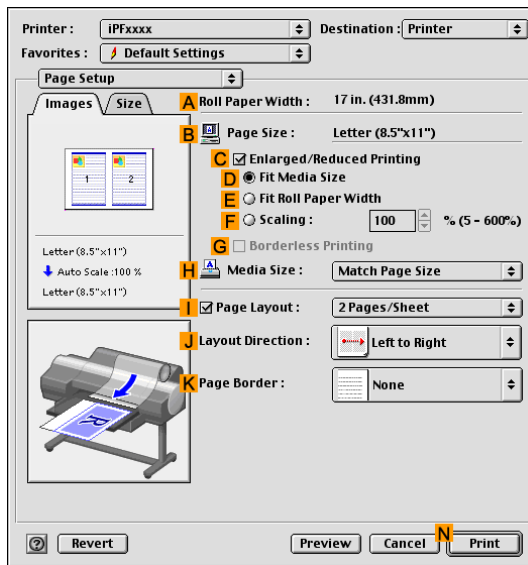

11. Select the **I Page Layout** check box.
12. Click **Poster (2 x 2)** in the **I Page Layout** list.
13. In the **Pages to Print** dialog box, clear the check boxes of any portion you do not want to print.
14. Access the **Finishing** pane.

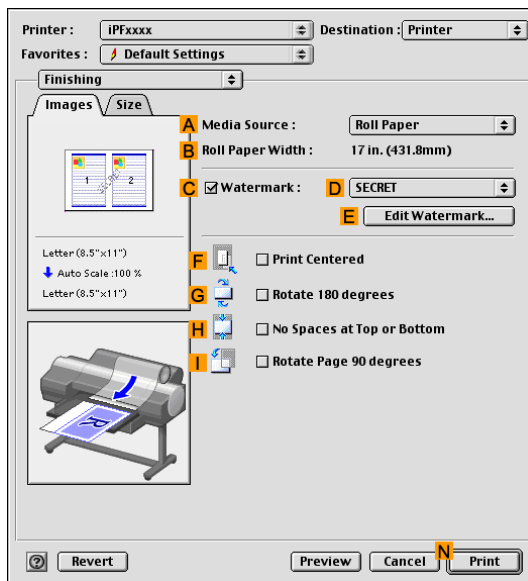

15. Click **Paper Tray Feed** in the **A Media Source** list.
16. Confirm the print settings, and then click **N Print** to start printing.



Note

- For tips on confirming print settings, see "Confirming Print Settings (Mac OS 9)". (→P.518)

Printing Multiple Originals Next to Each Other (Windows)

This topic describes how to arrange multiple originals using the Free Layout function.

1. Choose **Print** in the application menu.
2. Select the printer in the dialog box, and then open the printer driver dialog box. (→P.473)
3. Make sure the **Main** sheet is displayed.

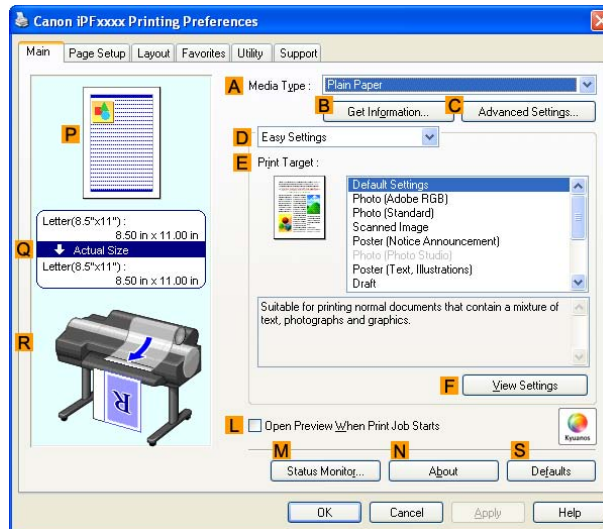

4. Click the **Layout** tab to display the **Layout** sheet.

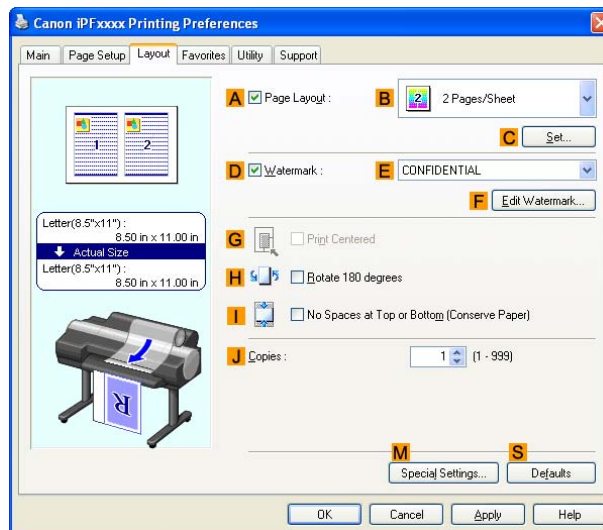

5. Select the **A** **Page Layout** check box.
6. Click **Free Layout** in the **B** **Page Layout** list.

7. When you attempt to print, the imagePROGRAF Free Layout window is displayed. (At this point, the document will not be printed yet.)

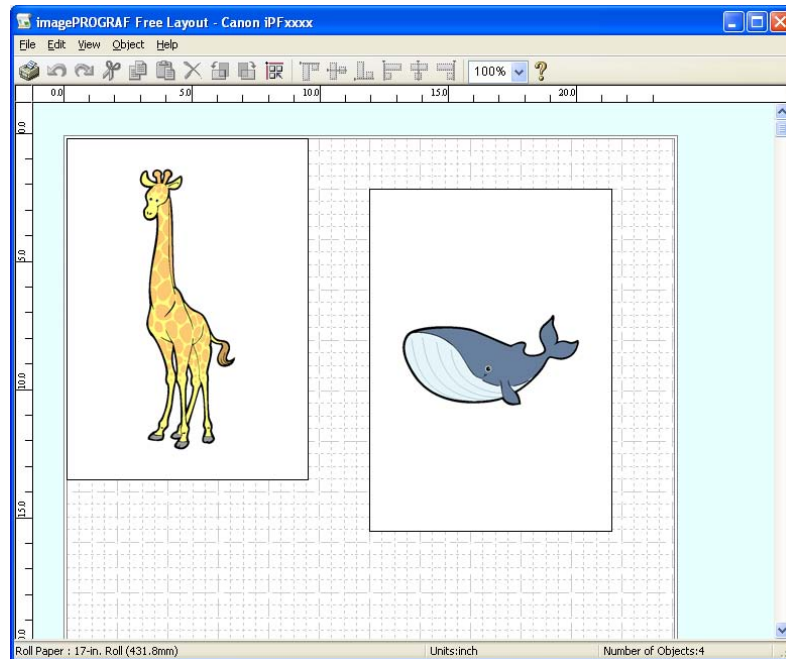

8. Edit and rearrange the image in the imagePROGRAF Free Layout window as desired.



Important

- Without closing the imagePROGRAF Free Layout window, repeat steps 1-7 to arrange originals from multiple applications on the same page.



Note

- For instructions on editing and rearranging images, refer to the imagePROGRAF Free Layout help topic.

9. Print from the imagePROGRAF Free Layout menu.



Note

- For details on imagePROGRAF Free Layout functions, refer to Free Layout Guide .

Printing Multiple Originals Next to Each Other (Mac OS X)

This topic describes how to use the **Free Layout** function to arrange multiple originals next to each other before printing.

1. Choose **Print** in the application menu.
2. Click **PDF** and select **Canon imagePROGRAF Free Layout**.

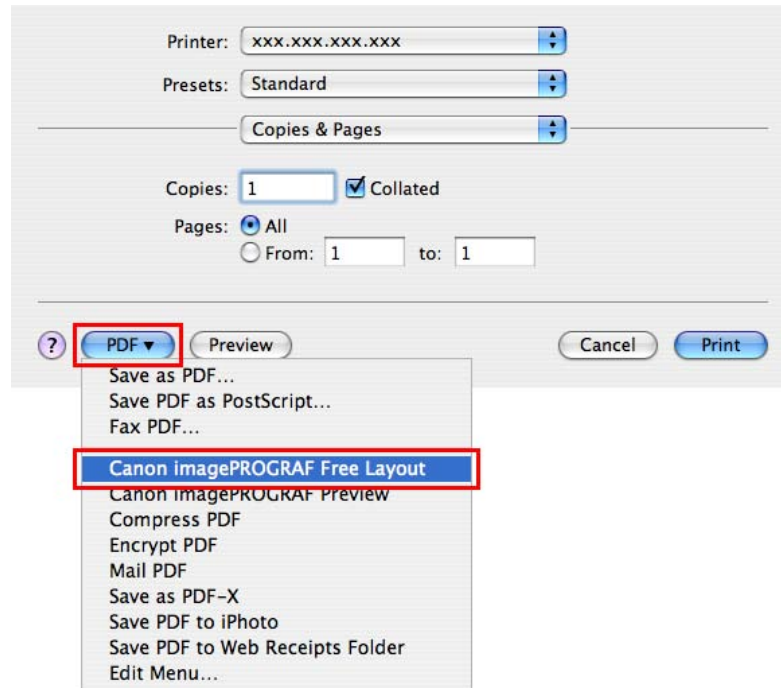

3. The **Canon imagePROGRAF Free Layout** window is displayed.

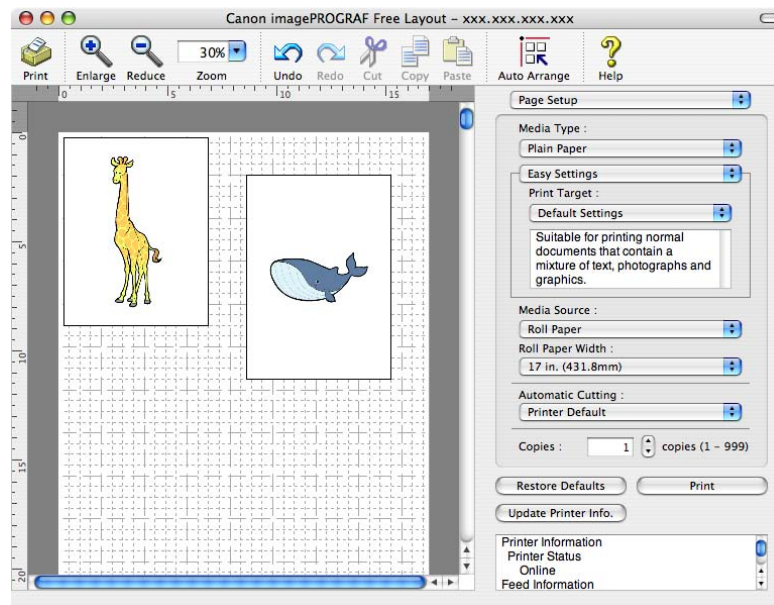

4. Edit and rearrange the image in the **Canon imagePROGRAF Free Layout** window as desired.



Important

- Without closing the **Canon imagePROGRAF Free Layout** window, repeat steps 1-7 to arrange originals from multiple applications on the same page.



Note

- For instructions on editing and rearranging images, refer to the **Canon imagePROGRAF Free Layout** help topic.

5. Print from the **Canon imagePROGRAF Free Layout** menu.



Note

- For details on **Canon imagePROGRAF Free Layout** functions, refer to Free Layout Guide .

Printing Multiple Pages Continuously (Windows)

This topic describes how to print multiple pages as a single continuous image, without margins between pages.



Important

- This feature is only available with rolls. It cannot be used when printing on sheets.
- During banner printing, settings for conserving paper, number of copies, borderless printing, enlargement or reduction, and other layout-related settings are disregarded.

1. Choose **Print** in the application menu.
2. Select the printer in the dialog box, and then display the printer driver dialog box. (→P.473)
3. Make sure the **Main** sheet is displayed.

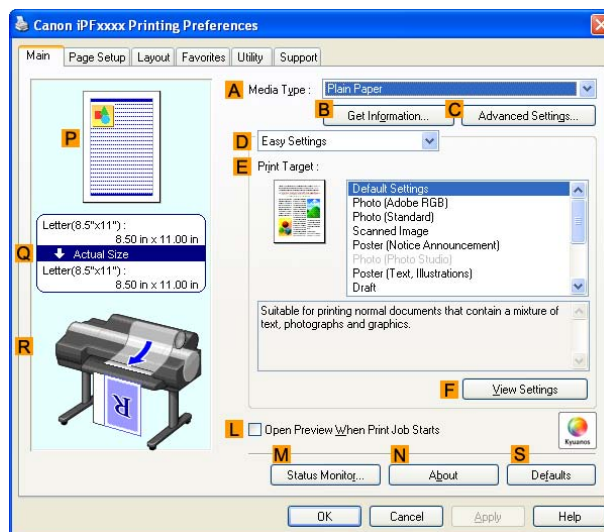

4. In the **A Media Type** list, click the type of paper that is loaded.
5. Click the **Page Setup** tab to display the **Page Setup** sheet.

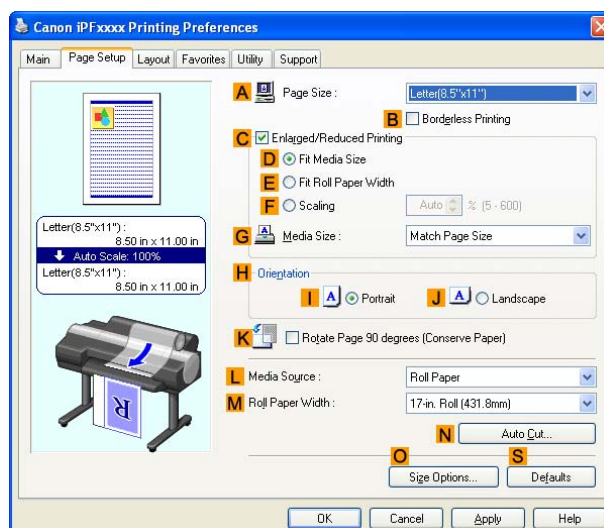

6. Click **Roll Paper (Banner)** in the **L Media Source** list.
7. Confirm the print settings and start printing.



Note

- For tips on confirming print settings, see “Confirming Print Settings (Windows)”. (→P.443)

Printing Multiple Pages Continuously (Mac OS X)

This topic describes how to print multiple pages as a single continuous image, without margins between pages.



Important

- This feature is only available with rolls. It cannot be used when printing on sheets.
- During banner printing, settings for conserving paper, number of copies, borderless printing, enlargement or reduction, and other layout-related settings are disregarded.

1. Choose **Page Setup** in the application menu to display the **Page Attribute** dialog box.

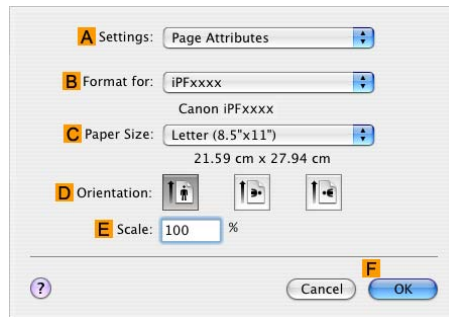

2. Select the printer in the **B Format for** list.
3. Click the original size in the **C Paper Size** list.
4. Click **F OK** to close the dialog box.
5. In the source application menu, choose **Print**.
6. Access the **Main** pane.

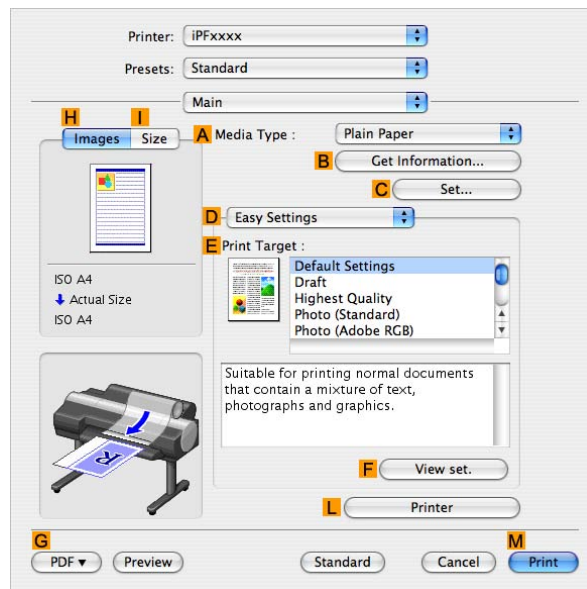

7. In the **A Media Type** list, click the type of paper that is loaded.
8. Make your selection in the **E Print Target** list.

9. Access the Page Setup pane.

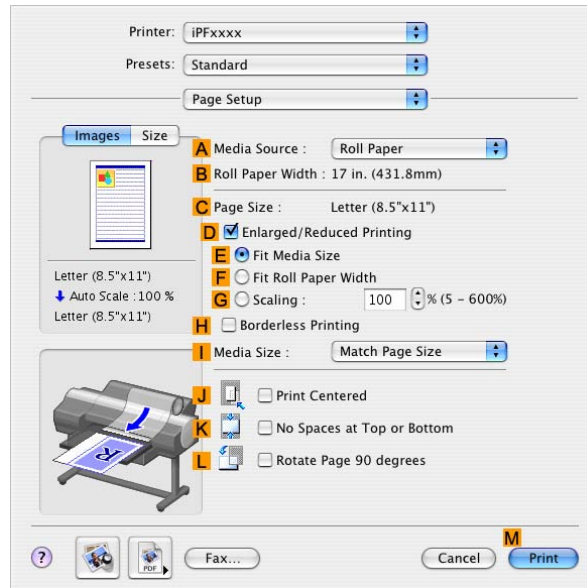

10. Click Roll Paper (Banner) in the A Media Source list.

11. Confirm the print settings, and then click M Print to start printing.



Note

- For tips on confirming print settings, see “Confirming Print Settings (Mac OS X)”. (→P.493)

Printing Multiple Pages Continuously (Mac OS 9)

This topic describes how to print multiple pages as a single continuous image, without margins between pages.



Important

- This feature is only available with rolls. It cannot be used when printing on sheets.
- During banner printing, settings for conserving paper, number of copies, borderless printing, enlargement or reduction, and other layout-related settings are disregarded.

1. Select the printer in **Chooser**.
2. Choose **Page Setup** from the application menu to display the **Page Attribute** dialog box.

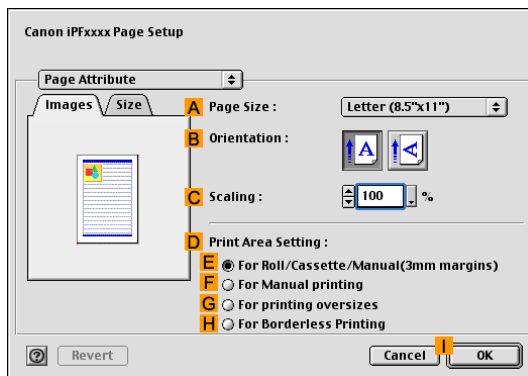

3. Click the original size in the **A Page Size** list.
4. Click **I OK** to close the dialog box.
5. In the source application menu, choose **Print**.
6. Make sure the **Main** pane is displayed.

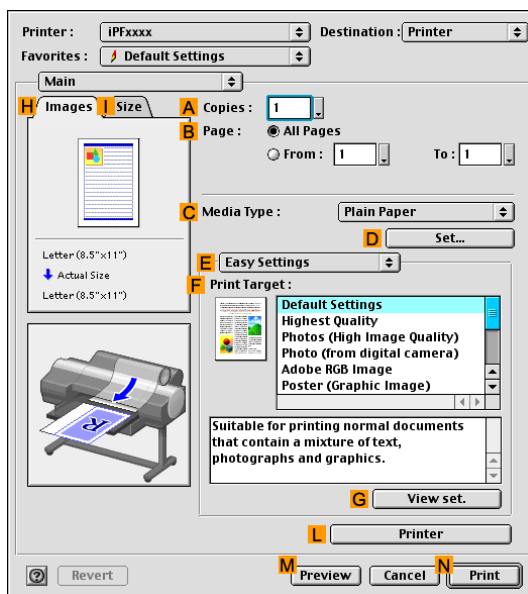

7. In the **C Media Type** list, click the type of paper that is loaded.
8. Make your selection in the **F Print Target** list.

9. Access the **Finishing** pane.

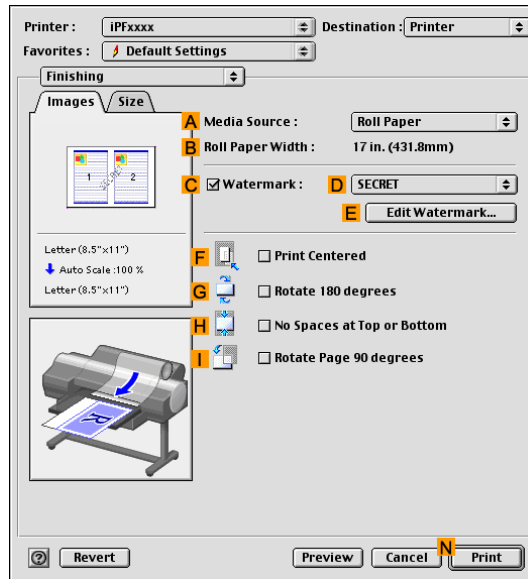

10. Click **Roll Paper (Banner)** in the **A Media Source** list.

11. Confirm the print settings, and then click **N Print** to start printing.



Note

- For tips on confirming print settings, see “Confirming Print Settings (Mac OS 9)”. (→P.518)

Printing Multiple Pages Per Sheet (Windows)

This topic describes how to print four pages of originals together on a single sheet based on the following example.

- Document: Any Type
- Page size: A3 (297.0×420.0 mm [11.7×16.5 in])
- Paper: Roll
- Paper type: Plain Paper
- Roll paper width: A2/A3 roll (420.0 mm [16.5 in])

1. Choose **Print** in the application menu.
2. Select the printer in the dialog box, and then open the printer driver dialog box. (→P.473)
3. Make sure the **Main** sheet is displayed.

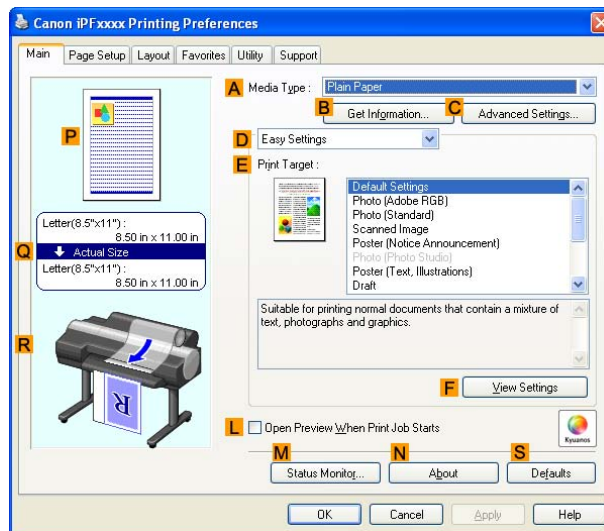

4. In the **A Media Type** list, select the type of paper that is loaded. In this case, click Plain Paper.
5. Select the printing application in the **E Print Target** list.
6. Click the **Page Setup** tab to display the **Page Setup** sheet.

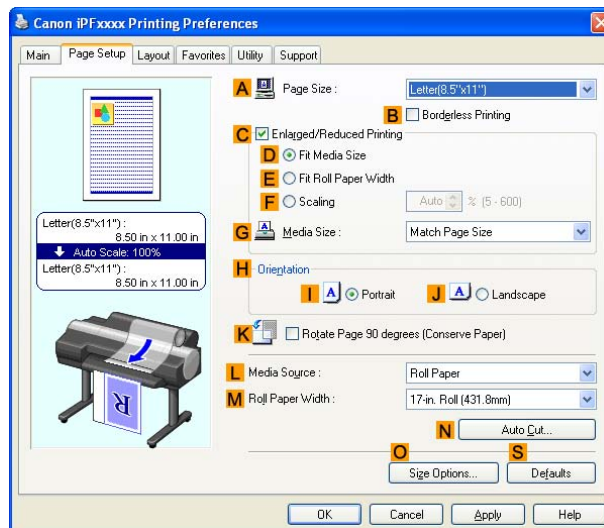

7. In **A Page Size**, click the size of the original as specified in the application software. In this case, click **ISO A4** or **Letter (8.5"x11")**.
8. Click **Roll Paper** in the **L Media Source** list.
9. Select the width of the loaded roll in the **M Roll Paper Width** list-in this case, **ISO A2/A3 Roll (420.0mm)**.
10. Click the **Layout** tab to display the **Layout** sheet.

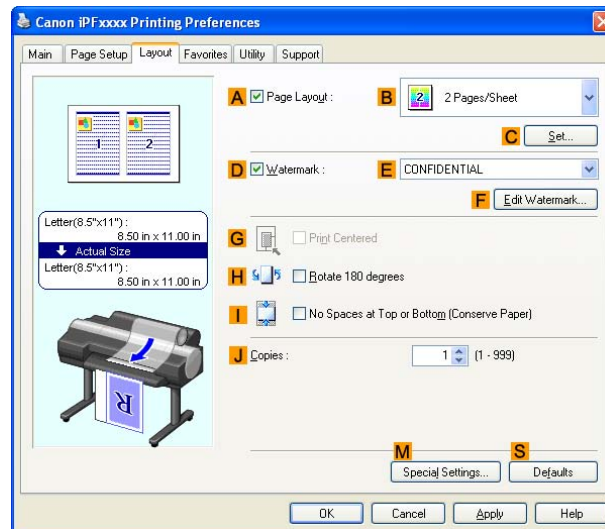

11. Select the **A Page Layout** check box.
12. Click **4 Pages/Sheet** in the **B Page Layout** list.



Note

- You can select the layout order for placing four pages on a sheet and a frame border in the **Page Layout Printing** dialog box by clicking **C Set**.

13. Confirm the print settings and print as desired.



Note

- For tips on confirming print settings, see “Confirming Print Settings (Windows)”. (→P.443)

Printing Multiple Pages Per Sheet (Mac OS X)

This topic describes how to print four pages of originals together on a single sheet based on the following example.

- Document: Any Type
- Page size: A3 (297.0 × 420.0 mm [11.7 × 16.5 in])
- Paper: Roll
- Paper type: Plain Paper
- Roll paper width: A2/A3 roll (420.0 mm [16.5 in])

1. Choose **Page Setup** in the application menu to display the **Page Attribute** dialog box.

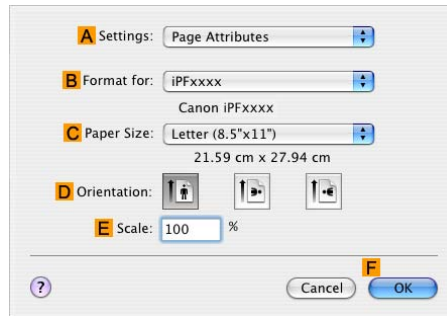

2. Select the printer in the **B Format for** list.

3. In the **C Paper Size** list, click the size of the original. In this case, click **ISO A3**.

4. Click **F OK** to close the dialog box.

5. Choose **Print** in the application menu.

6. Access the **Layout** pane.

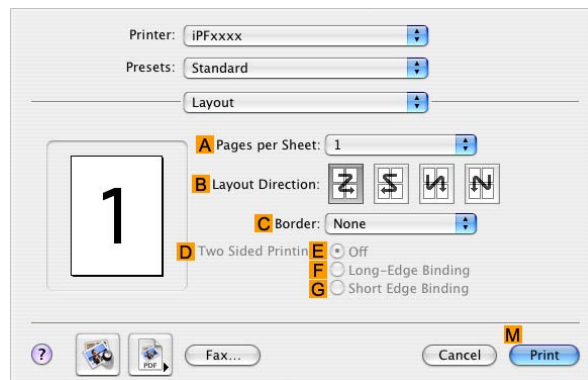

7. Click **4** in the **A Pages per Sheet** list.



Note

- You can choose the layout order and specify a boundary line for the four pages in **B Layout Direction** and **C Border** (or **Border**).

8. Access the **Main** pane.

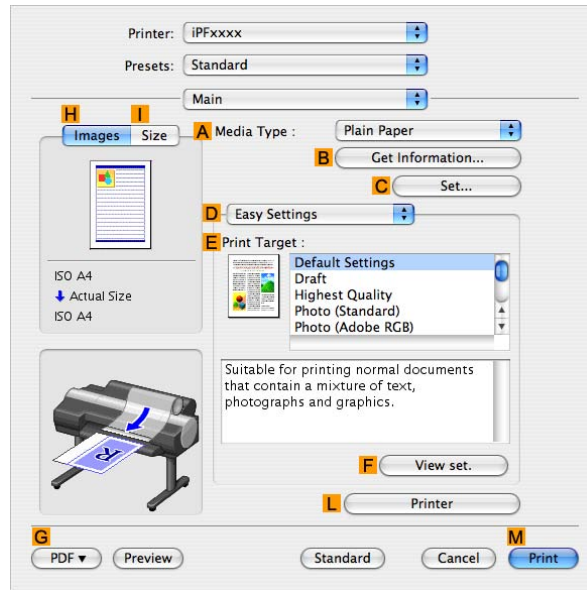

9. In the **A Media Type** list, select the type of paper that is loaded. In this case, click Plain Paper.

10. Select the printing application in the **E Print Target** list.

11. Access the **Page Setup** pane.

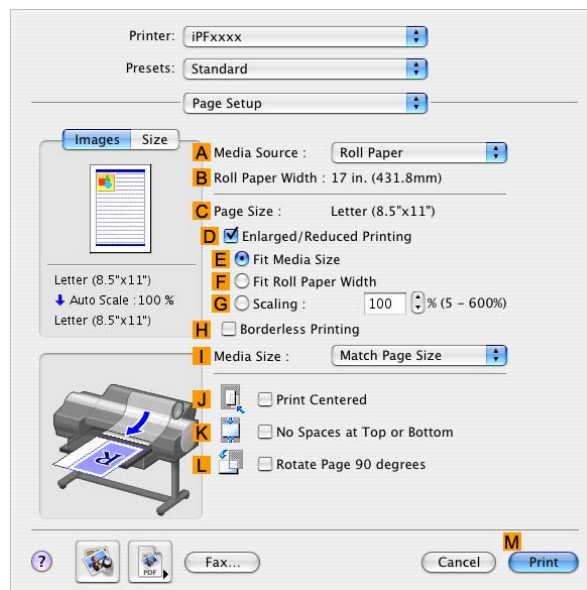

12. Click **Roll Paper** in the **A Media Source** list.

13. Make sure the width of the loaded roll is displayed in the **B Roll Paper Width** list-in this case, **ISO A2/A3 (420.0mm)**.



Note

- If the width of the loaded roll is not displayed in **B Roll Paper Width**, click **L Printer Information** on the **Main** pane and update the printer information.

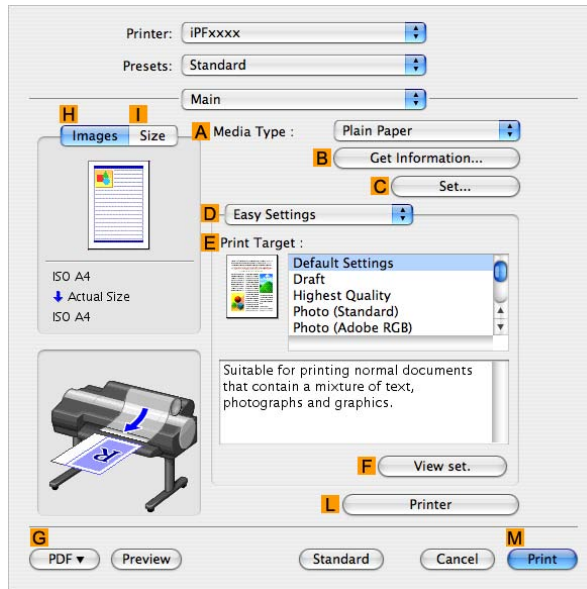

14. Make sure **C Page Size** shows the original size as specified in **C Paper Size** in the **Page Attribute** dialog box-in this case, **ISO A3**.

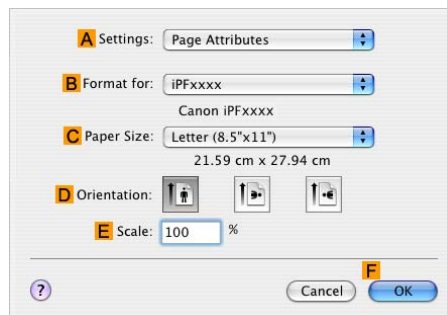

15. Confirm the print settings, and then click **M Print** to start printing.



Note

- For tips on confirming print settings, see “Confirming Print Settings (Mac OS X)”. (→P.493)

Printing Multiple Pages Per Sheet (Mac OS 9)

This topic describes how to print four pages of originals together on a single sheet based on the following example.

- Document: Any Type
- Page size: A3 (297.0 × 420.0 mm [11.7 × 16.5 in])
- Paper: Roll
- Paper type: Plain Paper
- Roll paper width: A2/A3 roll (420.0 mm [16.5 in])

1. Select the printer in **Chooser**.
2. Choose **Page Setup** from the application menu to display the **Page Attribute** dialog box.

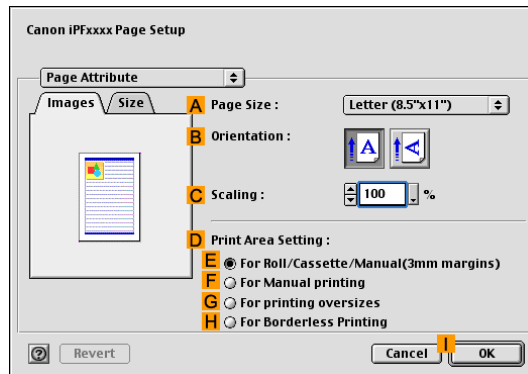

3. In the **A Page Size** list, click the size of the original. In this case, click **ISO A3**.
4. Click **I OK** to close the dialog box.
5. Choose **Print** in the application menu.
6. Make sure the **Main** pane is displayed.

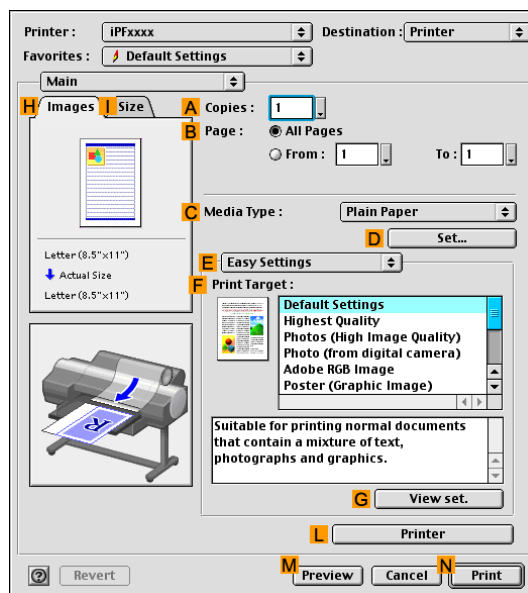

7. In the **C Media Type** list, select the type of paper that is loaded. In this case, click Plain Paper.
8. Select the print target in the **F Print Target** list.

9. Access the **Page Setup** pane.

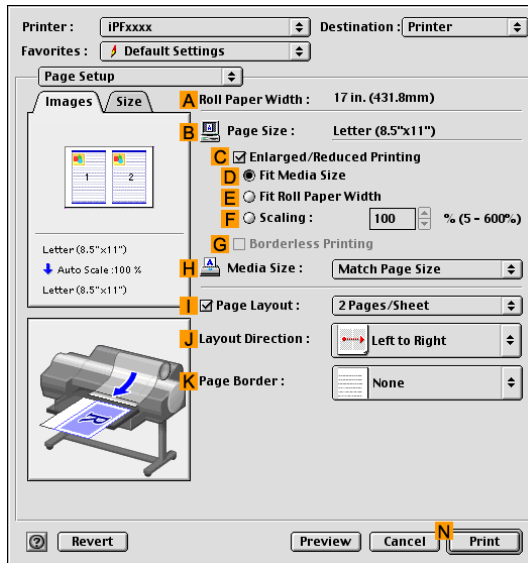

10. Select the **I Page Layout** check box.

11. Click **4 Pages/Sheet** in the **I Page Layout** list.



Note

- You can choose the layout order and specify a boundary line for the four pages in **J Layout Direction** and **K Page Border**.

12. Access the **Finishing** pane.

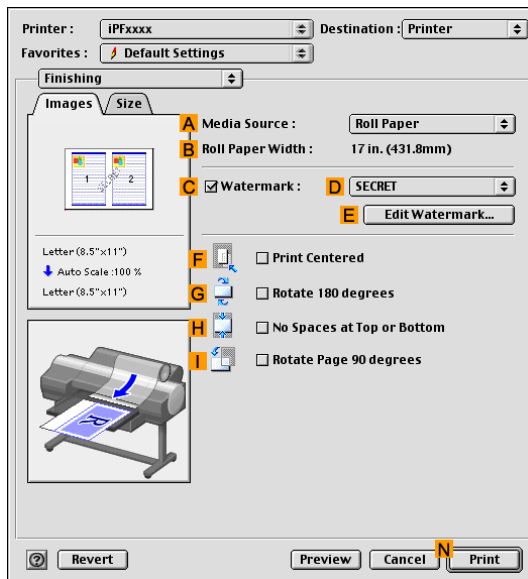

13. Click **Roll Paper** in the **A Media Source** list.

14. Make sure the width of the loaded roll is displayed in the **B Roll Paper Width** list-in this case, **ISO A2/A3 (420.0mm)**.



Note

- If the width of the loaded roll is not displayed in **B Roll Paper Width**, click **L Printer** on the **Main** pane and update the printer information.

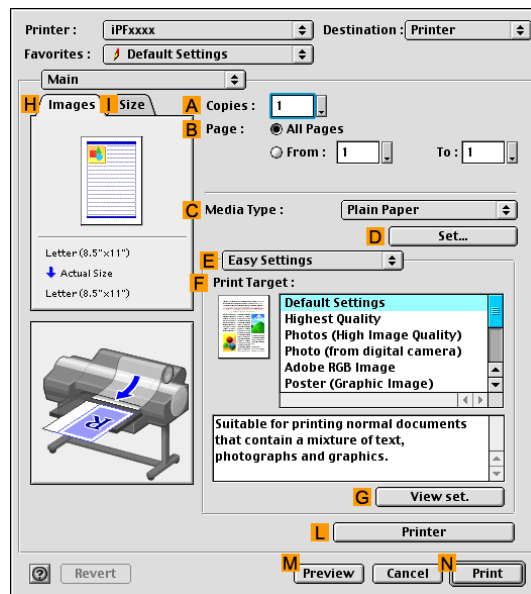

15. Confirm the print settings, and then click **N Print** to start printing.



Note

- For tips on confirming print settings, see “Confirming Print Settings (Mac OS 9)”. (→P.518)

Centering originals

☐☐☐ Printing Originals Centered on Rolls

You can print originals centered on a page—for example, if the paper is larger than the original, or if you are reducing the original.

Centering originals relative to roll paper width

If you use originals smaller than the roll paper width, you can center them relative to the width when printing.

Print Centered

Aligns the center of the original with the center of the roll, relative to the width.

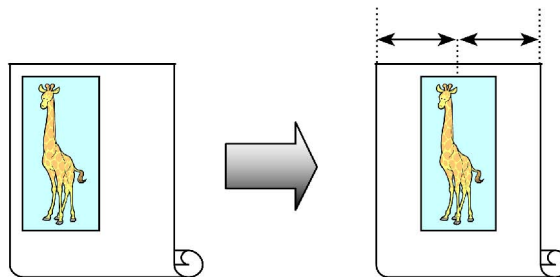

For instructions on centering originals when printing on rolls, refer to the following topics, as appropriate for your computer and operating system.

- Printing Originals Centered on Rolls (Windows) (→P.380)
- Printing Originals Centered on Rolls (Mac OS X) (→P.382)
- Printing Originals Centered on Rolls (Mac OS 9) (→P.385)

Printing Originals Centered on Sheets

You can print originals centered on a page—for example, if the paper is larger than the original, or if you are reducing the original.

Centering originals on sheets

If you use paper larger than the original size or print originals after reduction, the printed images may be aligned in the upper-left corner of the paper. In this case, you can center originals on sheets when printing.

Print Centered

Aligns the center of the original with the center of the sheet.

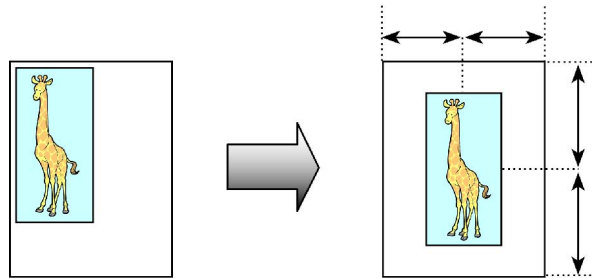

For instructions on centering originals when printing on sheets, refer to the following topics, as appropriate for your computer and operating system.

- Printing Originals Centered on Sheets (Windows) (→P.388)
- Printing Originals Centered on Sheets (Mac OS X) (→P.390)
- Printing Originals Centered on Sheets (Mac OS 9) (→P.392)

Printing Originals Centered on Rolls (Windows)

This topic describes how to center originals before printing on rolls based on the following example.

- Document: Any type
- Page size: A4 (210.0×297.0 mm)/Letter (8.3 × 11.7 in)
- Paper: Roll
- Paper type: Plain Paper
- Roll width: A3/A4 roll (297.0 mm [11.7 in])

1. Choose **Print** in the application menu.
2. Select the printer in the dialog box, and then display the printer driver dialog box. (→P.473)
3. Make sure the **Main** sheet is displayed.

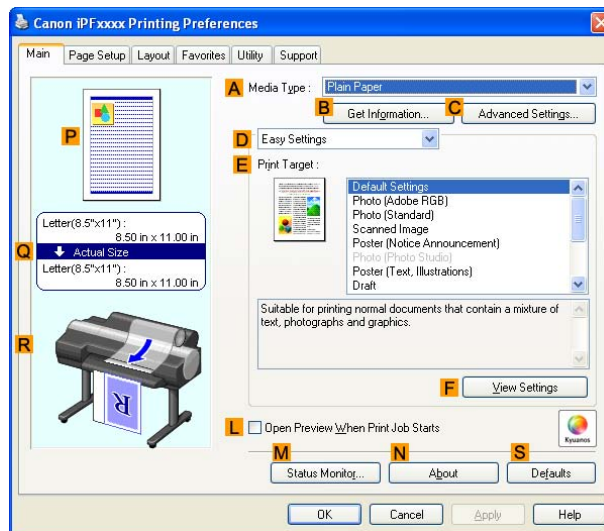

4. In the **A Media Type** list, select the type of paper that is loaded. In this case, click Plain Paper.
5. Select the print target in the **E Print Target** list.
6. Click the **Page Setup** tab to display the **Page Setup** sheet.

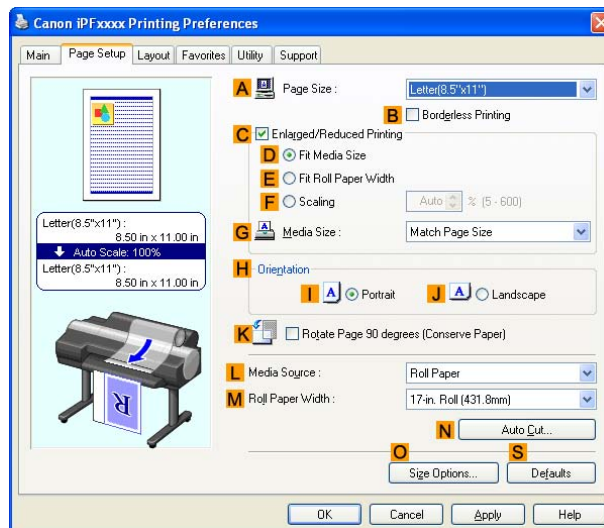

7. In the **A Page Size** list, click the size of the original as specified in the application. In this case, click **ISO A4** or **Letter (8.5"x11")**.
8. Click **Roll Paper** in the **L Media Source** list.
9. Select the width of the loaded roll in the **M Roll Paper Width** list-in this case, **ISO A3/A4 Roll (297.0mm)**.
10. Click the **Layout** tab to display the **Layout** sheet.

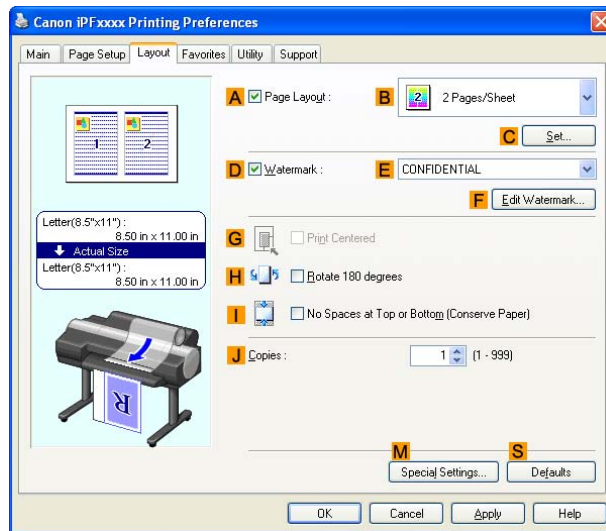

11. Select the **G Print Centered** check box.
12. Confirm the print settings and print as desired.



Note

- For tips on confirming print settings, see “Confirming Print Settings (Windows)”. (→P.443)

Printing Originals Centered on Rolls (Mac OS X)

This topic describes how to center originals before printing on rolls based on the following example.

- Document: Any type
- Page size: A4 (210.0×297.0mm)/Letter (8.3 × 11.7 in)
- Paper: Roll
- Paper type: Plain Paper
- Roll paper width: A3/A4 roll (297.00 mm [11.7 in])

1. Choose **Page Setup** from the application menu to display the **Page Attribute** dialog box.

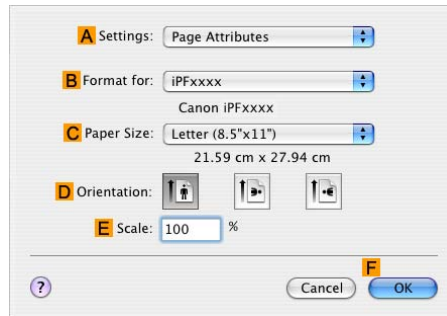

2. Select the print target in the **B Format for** list.

3. In **C Paper Size**, click the size of the original. In this case, click **ISO A4**.

4. Click **F OK** to close the dialog box.

5. Choose **Print** in the application menu.

6. Access the **Main** pane.

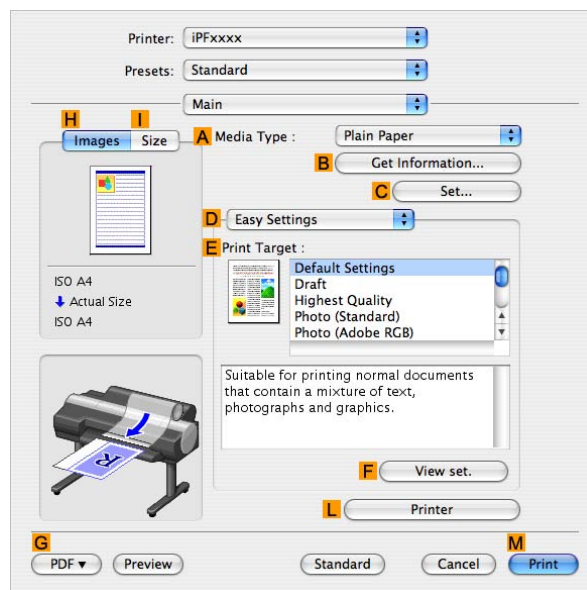

7. In the **A Media Type** list, select the type of paper that is loaded. In this case, click Plain Paper.

8. Select the print target in the **E Print Target** list.

9. Access the **Page Setup** pane.

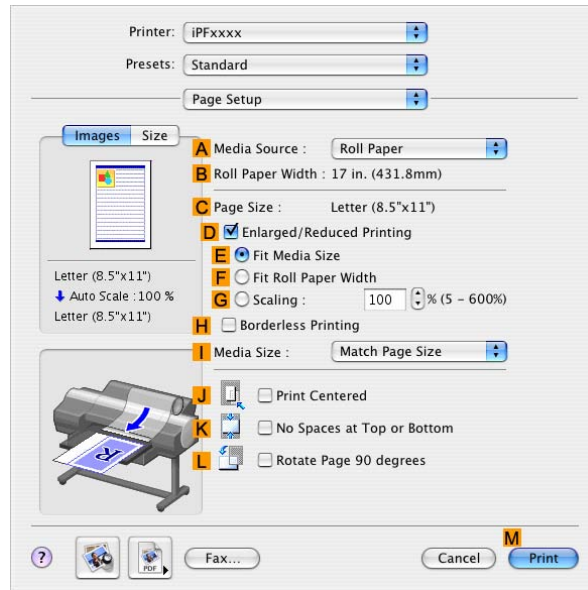

10. Click **Roll Paper** in the **A Media Source** list.

11. Make sure the width of the loaded roll is displayed in the **B Roll Paper Width** list—in this case, **10-in. Roll**.



Note

- If the width of the loaded roll is not displayed in **B Roll Paper Width**, click **L Printer Information** on the **Main** pane and update the printer information.

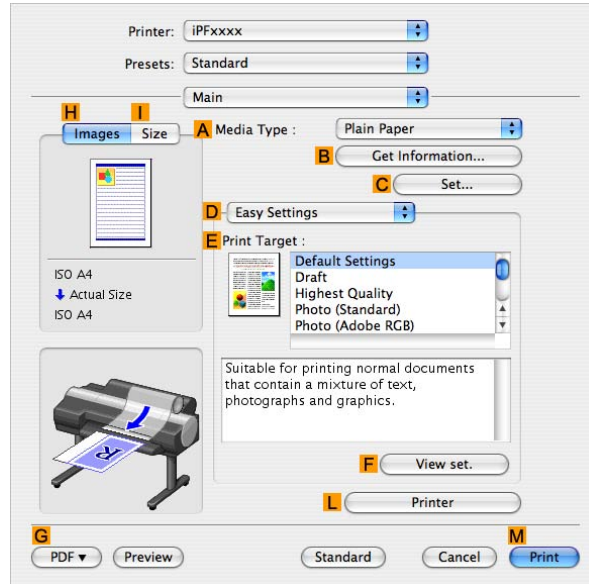

12. Make sure the **C Page Size** setting matches the original size as selected in **C Paper Size** in the **Page Attribute** dialog box-in this case, **ISO A4**.

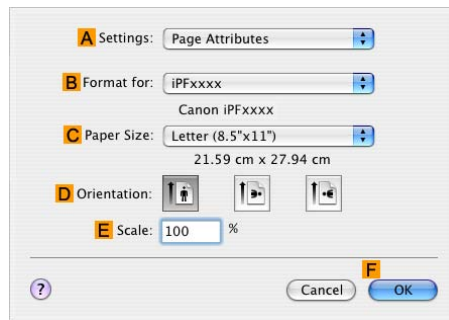

13. Select the **J Print Centered** check box.
14. Confirm the print settings, and click **M Print** to start printing.



Note

- For tips on confirming print settings, see “Confirming Print Settings (Mac OS X)”. (→P.493)

Printing Originals Centered on Rolls (Mac OS 9)

This topic describes how to center originals before printing on rolls based on the following example.

- Document: Any type
- Page size: A4 (210.0×297.0 mm)/Letter (8.3 × 11.7 in)
- Paper: Roll
- Paper type: Plain Paper
- Roll paper width: A3/A4 roll (297.0 mm [11.7 in])

1. Select the printer in **Chooser**.
2. Choose **Page Setup** from the application menu to display the **Page Attribute** dialog box.

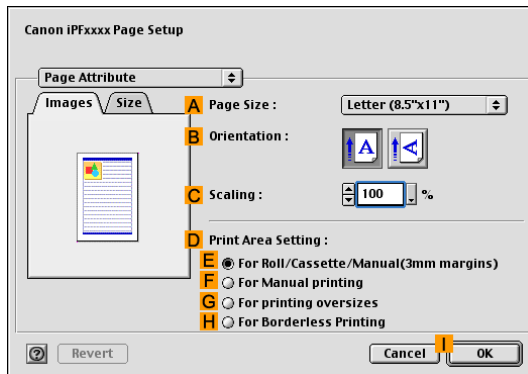

3. In **A Page Size**, click the size of the original. In this case, click **ISO A4**.
4. Click **I OK** to close the dialog box.
5. Choose **Print** in the application menu.
6. Make sure the **Main** pane is displayed.

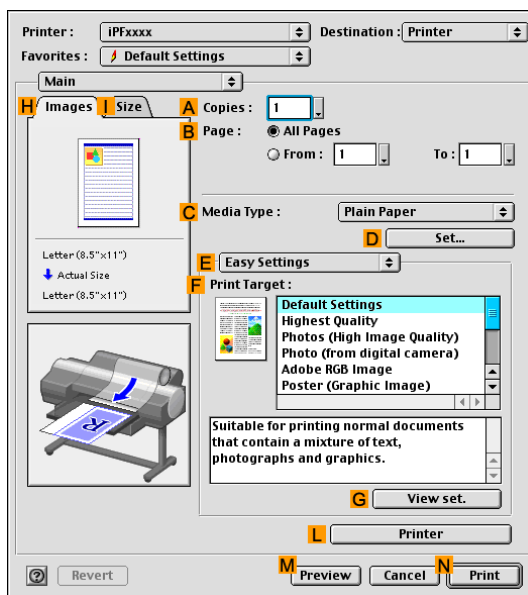

7. In the **C Media Type** list, select the type of paper that is loaded. In this case, click Plain Paper.
8. Select the print target in the **F Print Target** list.

9. Access the **Page Setup** pane.

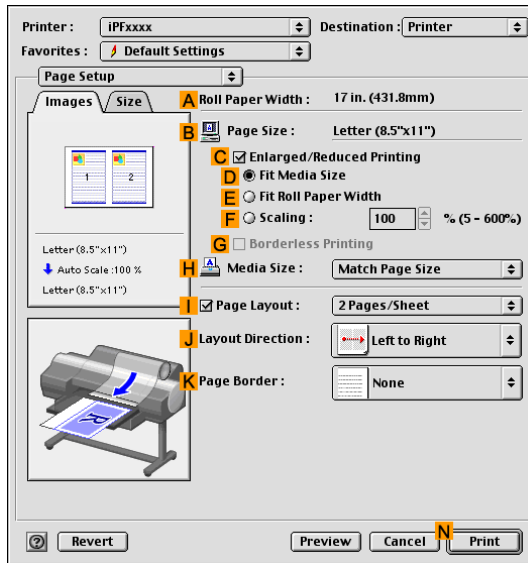

10. Make sure the **B Page Size** setting matches the original size as selected in **A Page Size** in the **Page Attribute** dialog box-in this case, **ISO A4**.

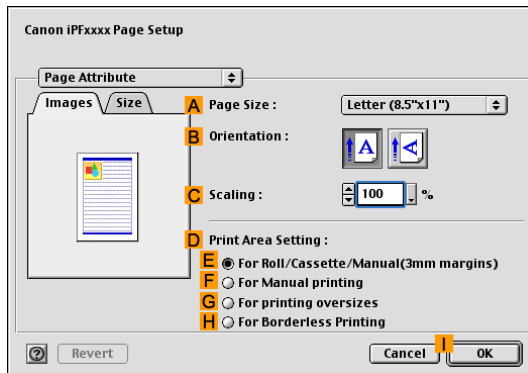

11. Access the **Finishing** pane.

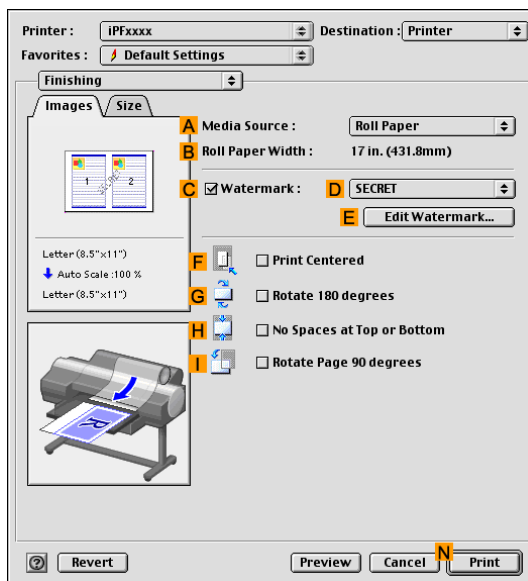

12. Click **Roll Paper** in the **A Media Source** list.
13. Make sure the width of the loaded roll is displayed in **B Roll Paper Width** -in this case, **ISO A3/A4 (297.0mm)**.



Note

- If the width of the loaded roll is not displayed in **B Roll Paper Width**, click **L Printer** on the **Main** pane and update the printer information.

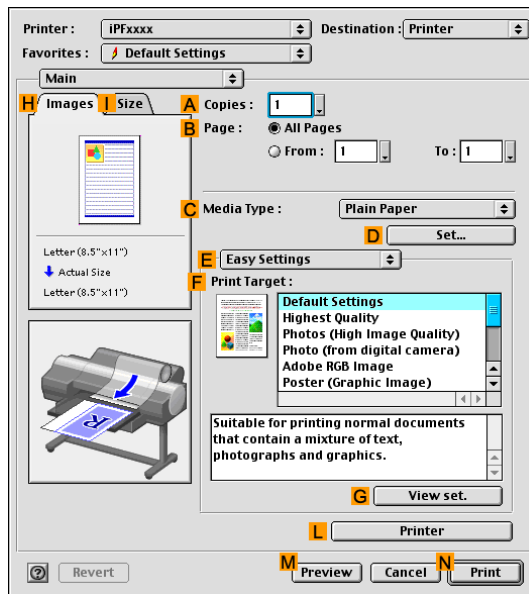

14. Select the **F Print Centered** check box.
15. Confirm the print settings, and click **N Print** to start printing.



Note

- For tips on confirming print settings, see “Confirming Print Settings (Mac OS 9)”. (→P.518)

Printing Originals Centered on Sheets (Windows)

This topic describes how to reduce an original 50% for printing centered on a sheet.

- Document: Any type
- Page size: A4 (210.0×297.0 mm)/Letter (8.3 × 11.7 in)
- Paper: Sheets (**Manual**)
- Paper Type: Plain Paper
- Paper size: A4 (210.0×297.0 mm)/Letter (8.3 × 11.7 in)

1. Choose **Print** in the application menu.
2. Select the printer in the dialog box, and then display the printer driver dialog box. (→P.473)
3. Make sure the **Main** sheet is displayed.

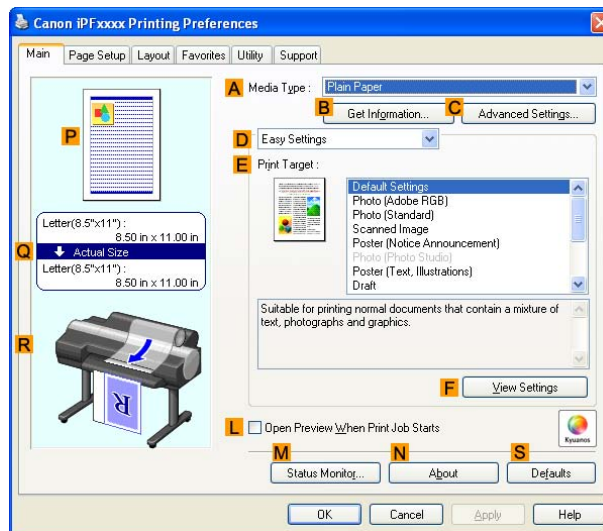

4. In the **A Media Type** list, select the type of paper that is loaded. In this case, click Plain Paper.
5. Select the type of document in the **E Print Target** list.
6. Click the **Page Setup** tab to display the **Page Setup** sheet.

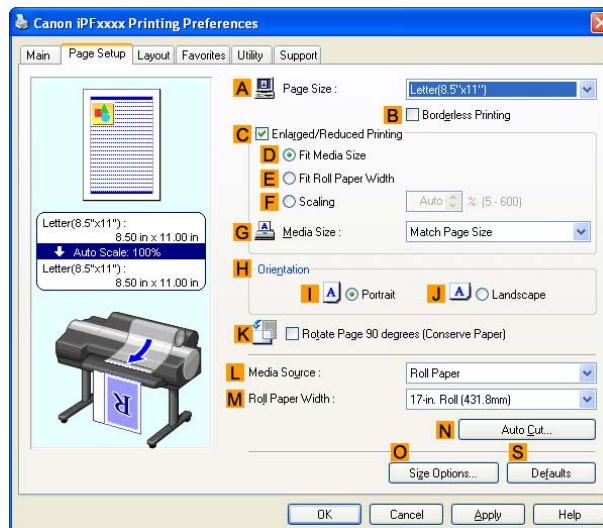

7. In **A Page Size**, click the size of the original as specified in the application software. In this case, click **ISO A4** or **Letter (8.5"x11")**.

8. Select the **C Enlarged/Reduced Printing** check box.
9. Click **Match Page Size** in the **G Media Size** list.
10. Click **F Scaling** and enter "50."
11. Click **Manual** in the **L Media Source** list.
12. Click the **Layout** tab to display the **Layout** sheet.

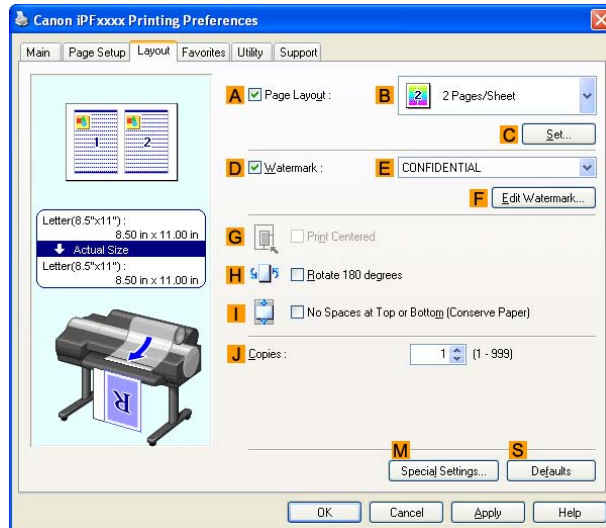

13. Select the **G Print Centered** check box.
14. Confirm the print settings and print as desired.



Note

- For instructions on confirming print settings, see "Confirming Print Settings (Windows)". (→P.443)



Important

- If you have selected **Manual** as the media source but have not loaded the paper yet, follow the instructions on the printer control panel to complete the size setting before loading the paper.

Printing Originals Centered on Sheets (Mac OS X)

This topic describes how to center originals for printing on sheets, based on the following example.

- Document: Any type
- Page size: A4/Letter
- Paper: Sheets
- Paper type: Plain Paper
- Paper size: Non-standard

1. Choose **Page Setup** from the application menu to display the **Page Attribute** dialog box.

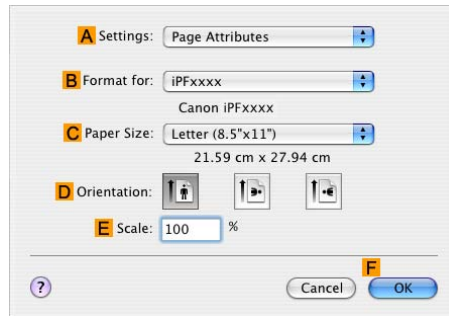

2. In the **C Paper Size** list, click the size of the original. In this case, click **ISO A4**.

3. Click **F OK** to close the dialog box.

4. In the application software menu, choose **Print**.

5. Access the **Main** pane.

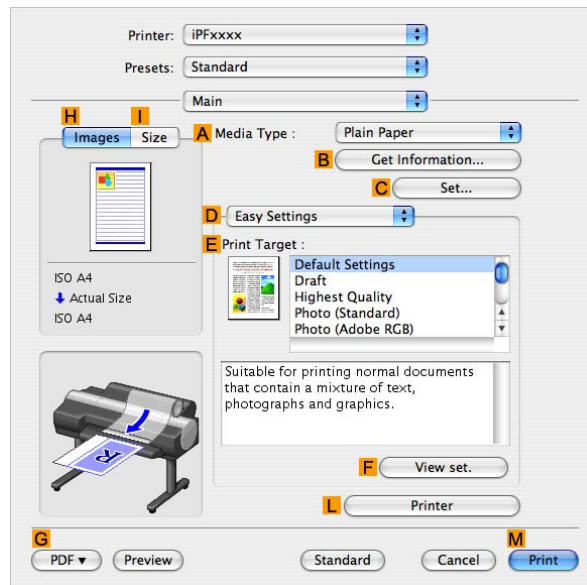

6. In the **A Media Type** list, select the type of paper that is loaded. In this case, click **Plain Paper**.

7. Select the printing application in the **E Print Target** list.

8. Access the **Page Setup** pane.

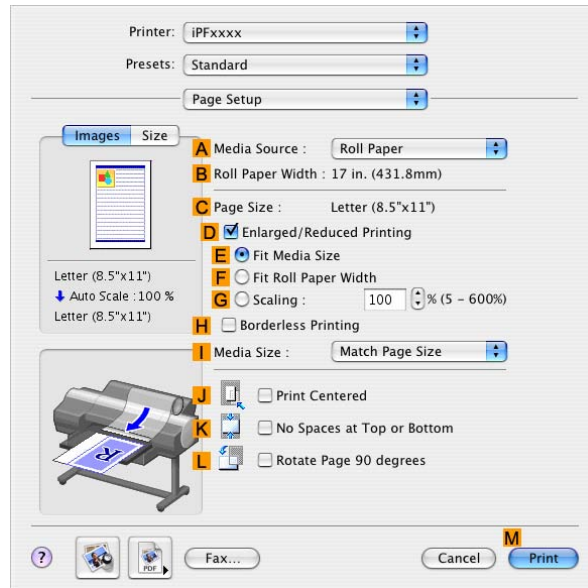

9. Click **Manual** in the **A Media Source** list.

10. Make sure **C Page Size** shows the original size as specified in **C Paper Size** in the **Page Attribute** dialog box-in this case, **ISO A4**.

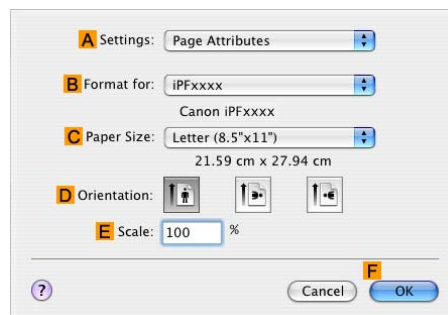

11. Select the **J Print Centered** check box.

12. Confirm the print settings, and then click **M Print** to start printing.



Note

- For tips on confirming print settings, see “Confirming Print Settings (Mac OS X)”. (→P.493)



Important

- If you have selected **Manual** as the media source but have not loaded the paper yet, follow the instructions on the printer control panel to complete the size setting before loading the paper.

Printing Originals Centered on Sheets (Mac OS 9)

This topic describes how to center originals for printing on sheets, based on the following example.

- Document: Any type
- Page size: A4/Letter
- Paper: Sheets (**Manual**)
- Paper type: Plain Paper
- Paper size: Non-standard

1. Choose **Page Setup** from the source application menu to display the **Page Attribute** dialog box.

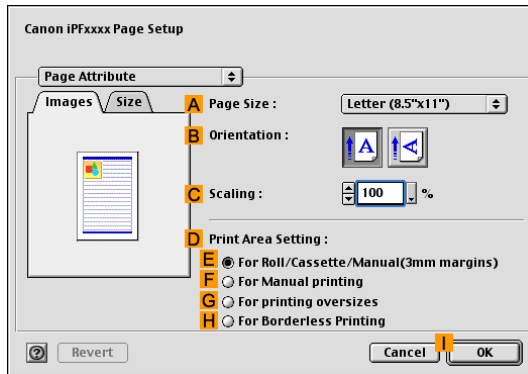

2. In the **A Page Size** list, click the size of the original. In this case, click **ISO A4**.

3. Click **I OK** to close the dialog box.

4. In the source application menu, choose **Print**.

5. Make sure the **Main** pane is displayed.

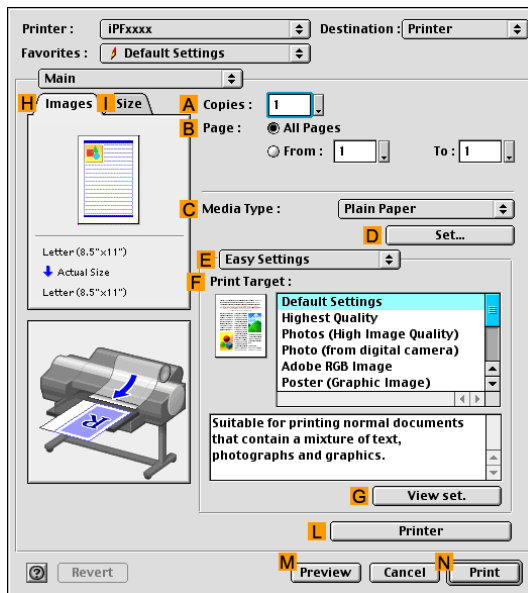

6. In the **C Media Type** list, select the type of paper that is loaded. In this case, click Plain Paper.

7. Select the printing application in the **F Print Target** list.

8. Access the **Page Setup** pane.

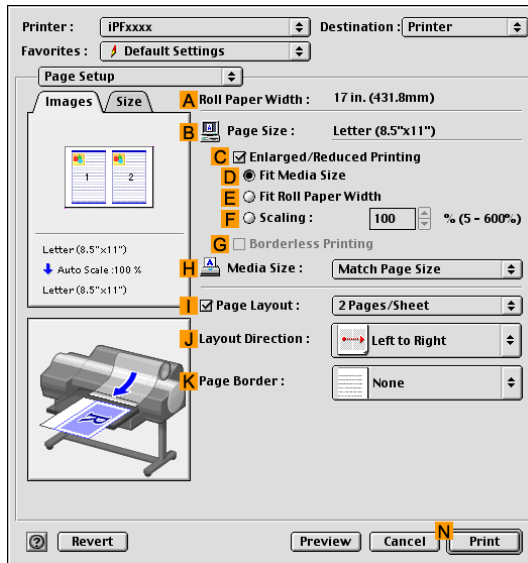

9. Make sure **B Page Size** shows the original size as specified in **Page Setup** in the **Page Attribute** dialog box-in this case, **ISO A4**.

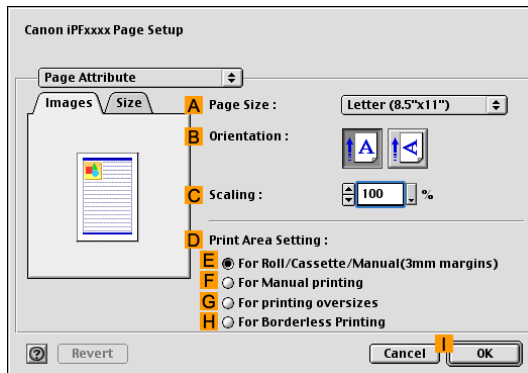

10. Access the **Finishing** pane.

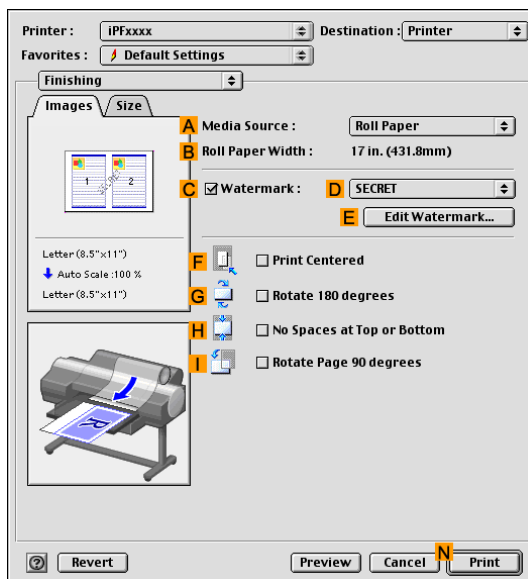

Centering originals

11. Click **Manual** in the **A Media Source** list.
12. Select the **F Print Centered** check box.
13. Confirm the print settings, and then click **N Print** to start printing.



Note

- For tips on confirming print settings, see “Confirming Print Settings (Mac OS 9)”. (→P.518)



Important

- If you have selected **Manual** as the media source but have not loaded the paper yet, follow the instructions on the printer control panel to complete the size setting before loading the paper.

Conserving roll paper

Conserving Roll Paper by Rotating Originals 90 Degrees

You can conserve roll paper by specifying particular settings as suitable for your original.

Rotate Page 90 degrees (Conserve Paper)

When originals are printed in portrait orientation, the original is rotated 90 degrees before printing if it fits within the roll width. This enables you to conserve paper.

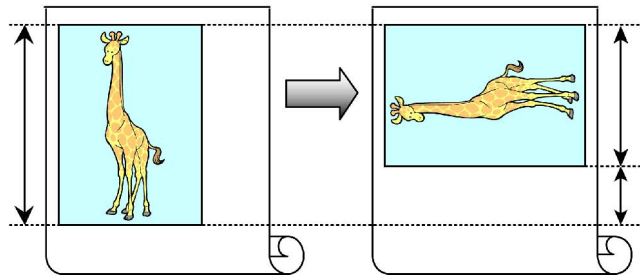

Important

- If the page would exceed the roll paper width after rotation, use this function with Scale to fit Roll Paper Width to print rotated pages.

For tips on conserving roll paper, refer to the following topics, as appropriate for your computer and operating system.

- Conserving Roll Paper by Rotating Originals 90 Degrees (Windows) (→P.404)
- Conserving Roll Paper by Rotating Originals 90 Degrees (Mac OS X) (→P.406)
- Conserving Roll Paper by Rotating Originals 90 Degrees (Mac OS 9) (→P.409)

Conserving Roll Paper by Printing Originals Without Top and Bottom Margins

You can conserve roll paper by specifying particular settings as suitable for your original.

No Spaces at Top or Bottom (Conserve Paper)

You can print without feeding the paper for blank portions of originals if there are top and bottom margins in originals. This enables you to conserve as much paper as the size of the margins.

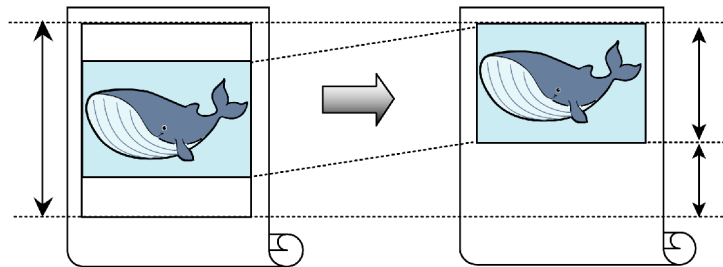

Important

- Printing without the top and bottom margins is not supported in the following cases.
 - Banner printing
 - If you have chosen poster as the type of page layout



Note

- Even during borderless printing, you can print without the top and bottom margins.
- Printing without the top and bottom margins may cause inconsistency in the size of printed documents, depending on the layout of images or text in your originals.

For tips on conserving roll paper, refer to the following topics, as appropriate for your computer and operating system.

- [Conserving Roll Paper by Printing Originals Without Top and Bottom Margins \(Windows\)](#) (→P.397)
- [Conserving Roll Paper by Printing Originals Without Top and Bottom Margins \(Mac OS X\)](#) (→P.399)
- [Conserving Roll Paper by Printing Originals Without Top and Bottom Margins \(Mac OS 9\)](#) (→P.402)

Conserving Roll Paper by Printing Originals Without Top and Bottom Margins (Windows)

This topic describes how to conserve roll paper when printing originals that have a top and bottom margin, based on the following example.

- Document: Any type
- Page size: A4 (210.0×297.0mm)/Letter (8.3 × 11.7 in)
- Paper: Roll
- Paper type: Plain Paper
- Roll paper width: A3/A4 roll (297.0 mm [11.7 in])

1. Choose **Print** in the application menu.
2. Select the printer in the dialog box, and then display the printer driver dialog box. (→P.473)
3. Make sure the **Main** sheet is displayed.

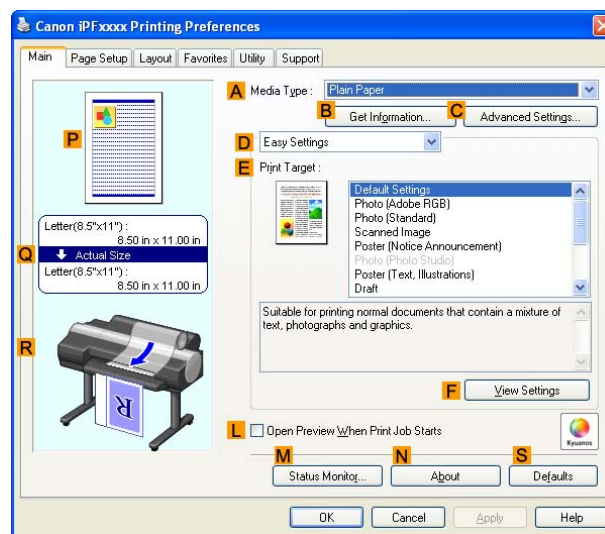

4. In the **Media Type** list, select the type of paper that is loaded. In this case, click Plain Paper.
5. Click the **Page Setup** tab to display the **Page Setup** sheet.

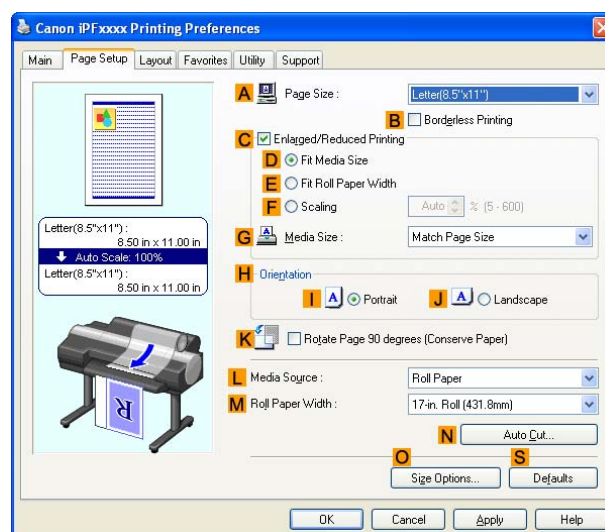

Conserving roll paper

6. In the **A Page Size** list, click the size of the original as specified in the application. In this case, click **ISO A4** or **Letter (8.5"x11")**.
7. Click **Roll Paper** in the **L Media Source** list.
8. Select the width of the loaded roll in the **M Roll Paper Width** list-in this case, **ISO A3/A4 Roll (297.0mm)**.
9. Click the **Layout** tab to display the **Layout** sheet.

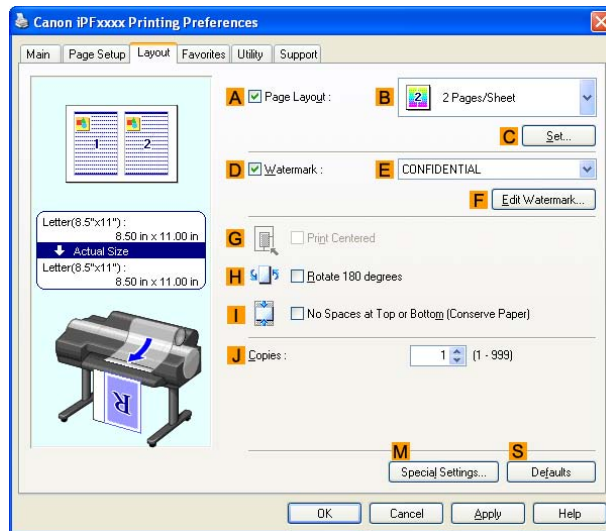

10. Select the **I No Spaces at Top or Bottom (Conserve Paper)** check box.
11. Confirm the print settings and print as desired.



Note

- For tips on confirming print settings, see "Confirming Print Settings (Windows)". (→P.443)

Conserving Roll Paper by Printing Originals Without Top and Bottom Margins (Mac OS X)

This topic describes how to conserve roll paper when printing originals that have a top and bottom margin, based on the following example.

- Document: Any type
- Page size: A4 (210.0×297.0 mm)/Letter (8.3 × 11.7 in)
- Paper: Roll
- Paper type: Plain Paper
- Roll paper width: A3/A4 roll (297.0 mm [11.7 in])

1. Choose **Page Setup** from the application menu to display the **Page Attribute** dialog box.

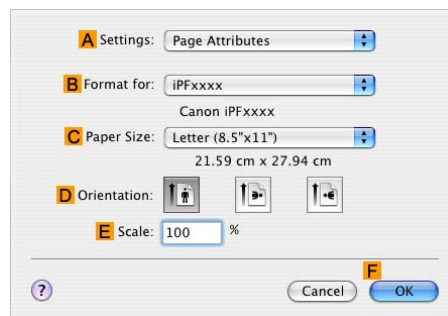

2. Select the print target in the **B Format for** list.

3. In **C Paper Size**, click the size of the original. In this case, click **ISO A4**.

4. Click **F OK** to close the dialog box.

5. Choose **Print** in the application menu.

6. Access the **Main** pane.

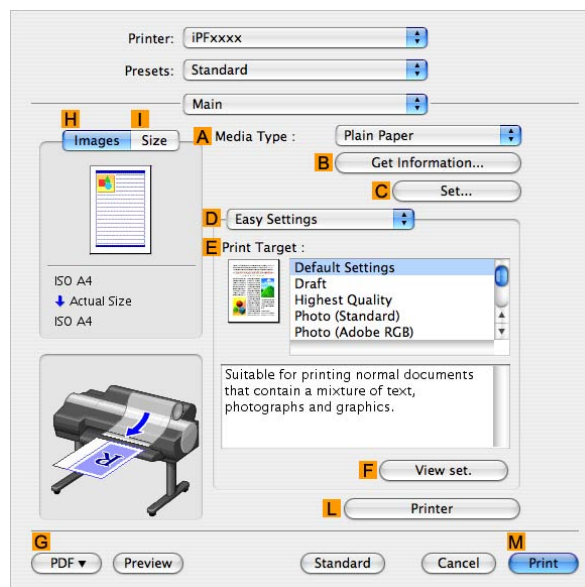

7. In the **A Media Type** list, select the type of paper that is loaded. In this case, click Plain Paper.

8. Access the **Page Setup** pane.

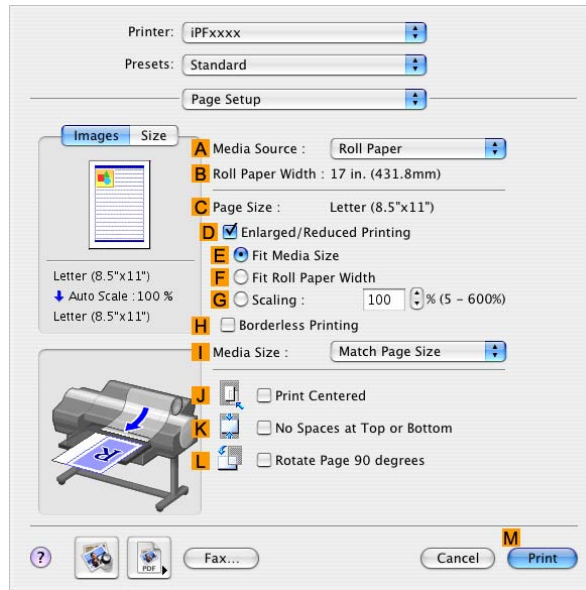

9. Click **Roll Paper** in the **A Media Source** list.

10. Make sure the width of the loaded roll is displayed in **B Roll Paper Width** -in this case, **ISO A3/A4 (297.0mm)**.



Note

- If the width of the loaded roll is not displayed in **B Roll Paper Width**, click **L Printer Information** on the **Main** pane and update the printer information.

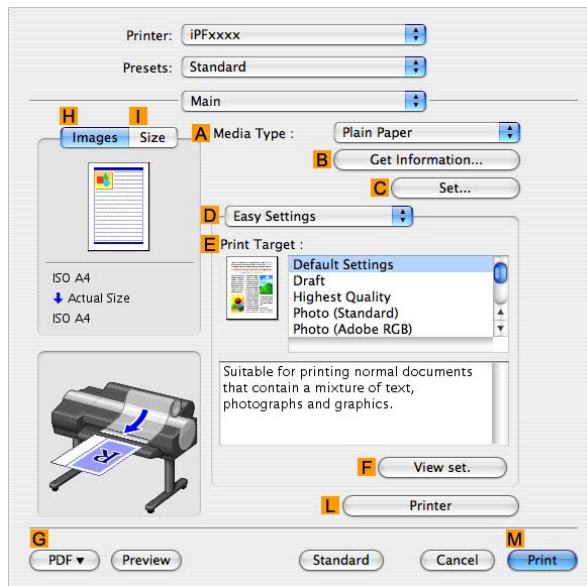

11. Make sure the **C Page Size** setting matches the original size as selected in **C Paper Size** in the **Page Attribute** dialog box-in this case, **ISO A4**.

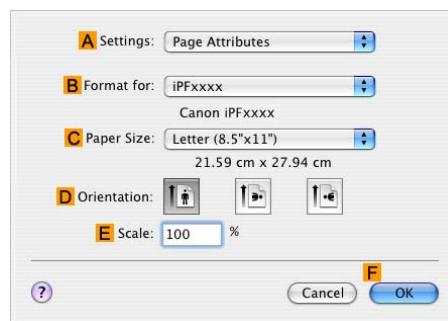

12. Select the **K No Spaces at Top or Bottom** check box.
13. Confirm the print settings, and click **M Print** to start printing.

**Note**

- For tips on confirming print settings, see “Confirming Print Settings (Mac OS X)”. (→P.493)

Conserving Roll Paper by Printing Originals Without Top and Bottom Margins (Mac OS 9)

This topic describes how to conserve roll paper when printing originals that have a top and bottom margin, based on the following example.

- Document: Any type
- Page size: A4 (210.0×297.0 mm)/Letter (8.3 × 11.7 in)
- Paper: Roll
- Paper type: Plain Paper
- Roll paper width: A3/A4 roll (297.0 mm [11.7 in])

1. Select the printer in **Chooser**.
2. Choose **Page Setup** from the application menu to display the **Page Attribute** dialog box.

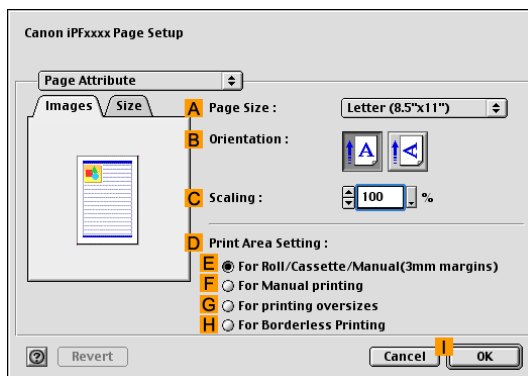

3. In **A Page Size**, click the size of the original. In this case, click **ISO A4**.
4. Click **I OK** to close the dialog box.
5. Choose **Print** in the application menu.
6. Make sure the **Main** pane is displayed.

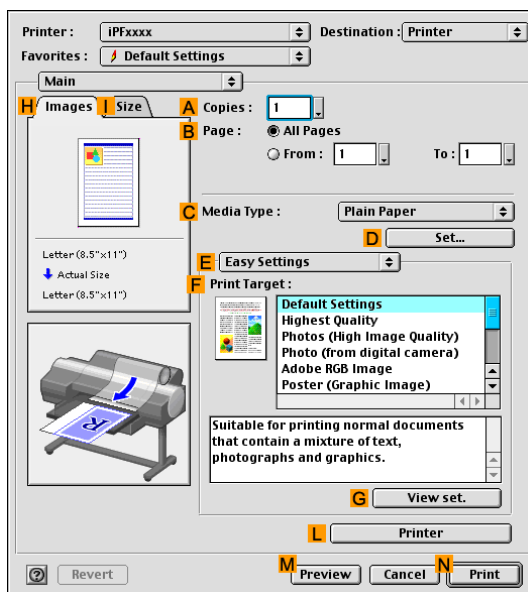

7. In the **C Media Type** list, select the type of paper that is loaded. In this case, click Plain Paper.

8. Access the **Finishing** pane.

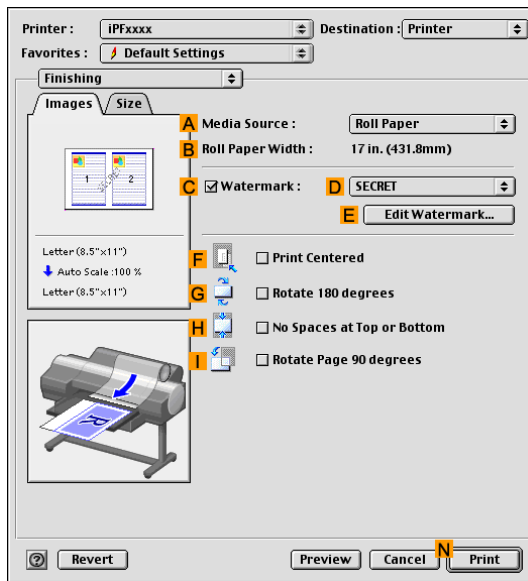

9. Click **Roll Paper** in the **A Media Source** list.

10. Make sure the width of the loaded roll is displayed in **B Roll Paper Width** -in this case, **ISO A3/A4 (297.0mm)**.



Note

- If the width of the loaded roll is not displayed in **B Roll Paper Width**, click **L Printer** on the **Main** pane and update the printer information.

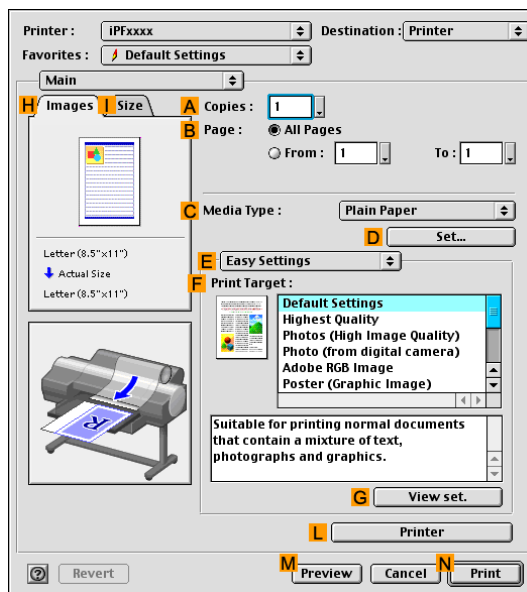

11. Select the **H No Spaces at Top or Bottom** check box.

12. Confirm the print settings, and click **N Print** to start printing.



Note

- For tips on confirming print settings, see “Confirming Print Settings (Mac OS 9)”. (→P.518)

Conserving Roll Paper by Rotating Originals 90 Degrees (Windows)

This topic describes how to conserve paper by rotating originals 90 degrees before printing, based on the following example.

- Document: Any type
- Page size: A4 (210.0×297.0 mm)/Letter (8.3×11.7 in)
- Paper: Roll
- Paper type: Plain Paper
- Roll paper width: A3/A4 roll (297.0 mm [11.7 in])

This example illustrates how to rotate an A4 (210.0×297.0 mm)/Letter (8.3×11.7 in) original in portrait orientation 90 degrees to fit within the width of A3/A4 roll paper (297.0 mm [11.7 in]), which enables you to conserve paper.

1. Choose **Print** in the application menu.
2. Select the printer in the dialog box, and then open the printer driver dialog box. (→P.473)
3. Make sure the **Main** sheet is displayed.

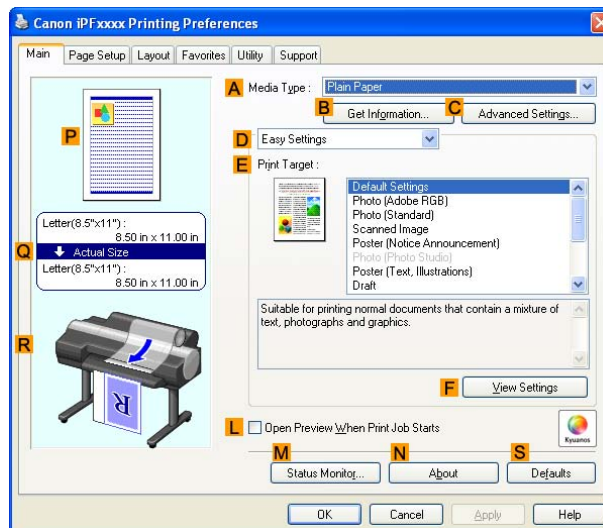

4. In the **Media Type** list, select the type of paper that is loaded. In this case, click Plain Paper.
5. Click the **Page Setup** tab to display the **Page Setup** sheet.

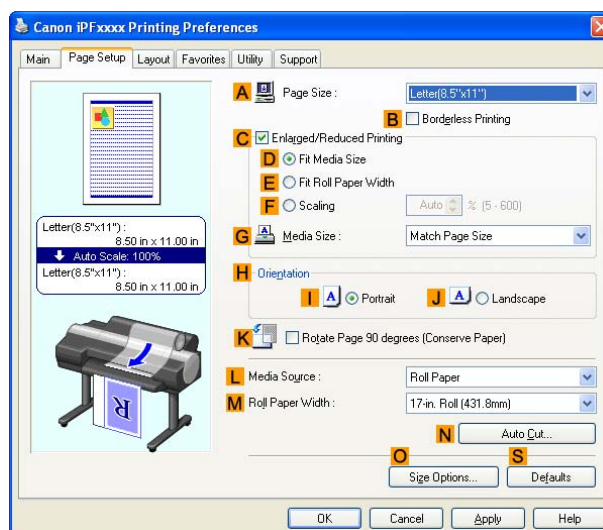

6. In the **A Page Size** list, click the size of the original as specified in the application. In this case, click **ISO A4** or **Letter (8.5"x11")**.
7. Click **Roll Paper** in the **L Media Source** list.
8. Select the width of the loaded roll in the **M Roll Paper Width** list-in this case, **ISO A3/A4 Roll (297.0mm)**.
9. Select the **K Rotate Page 90 degrees (Conserve Paper)** check box.
10. Confirm the print settings and print as desired.

**Note**

- For tips on confirming print settings, see “Confirming Print Settings (Windows)”. (→P.443)

Conserving Roll Paper by Rotating Originals 90 Degrees (Mac OS X)

This topic describes how to conserve roll paper by rotating originals 90 degrees before printing, based on the following example.

- Document: Any type
- Page Size: A4 (210.0×297.0 mm)/Letter (8.3 × 11.7 in)
- Paper: Roll
- Paper type: Plain Paper
- Roll paper width: A3/A4 roll (297.0 mm [11.7 in])

This example illustrates how to rotate an A4 (210.0×297.0 mm)/Letter (8.3 × 11.7 in) original in portrait orientation 90 degrees to fit within the width of A3/A4 roll (297.0 mm [11.7 in]), which enables you to conserve paper.

1. Choose **Page Setup** in the application menu to display the **Page Attribute** dialog box.

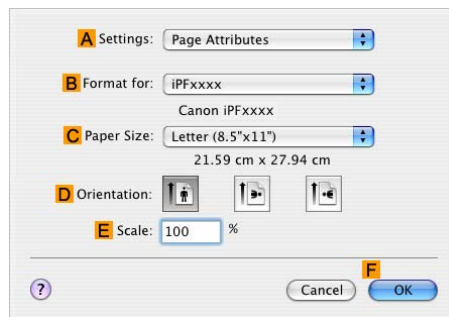

2. Select the printer in the **B Format for** list.

3. In the **C Paper Size** list, click the size of the original. In this case, click **ISO A4**.

4. Click **F OK** to close the dialog box.

5. Choose **Print** in the application menu.

6. Access the **Main** pane.

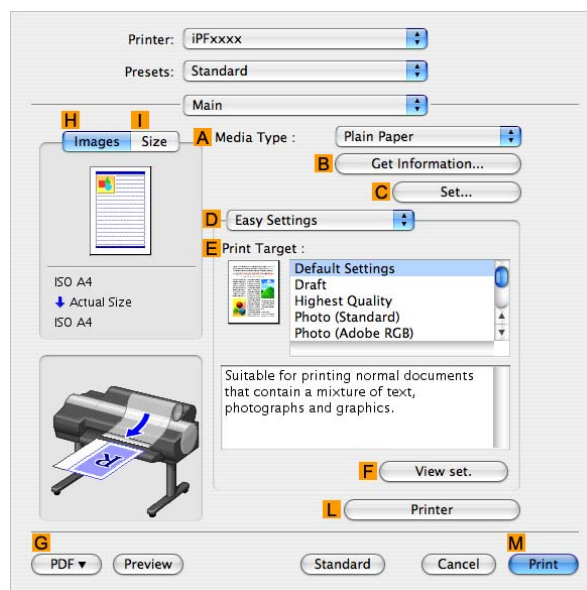

7. In the **A Media Type** list, select the type of paper that is loaded. In this case, click **Plain Paper**.

8. Access the **Page Setup** pane.

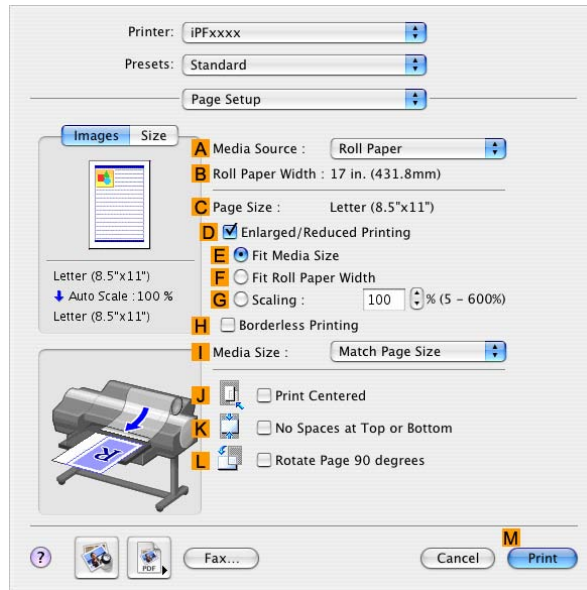

9. Click **Roll Paper** in the **A Media Source** list.

10. Make sure the width of the loaded roll is displayed in **B Roll Paper Width** -in this case, **ISO A3/A4 (297.0mm)**.



Note

- If the width of the loaded roll is not displayed in **B Roll Paper Width**, click **L Printer Information** on the **Main** pane and update the printer information.

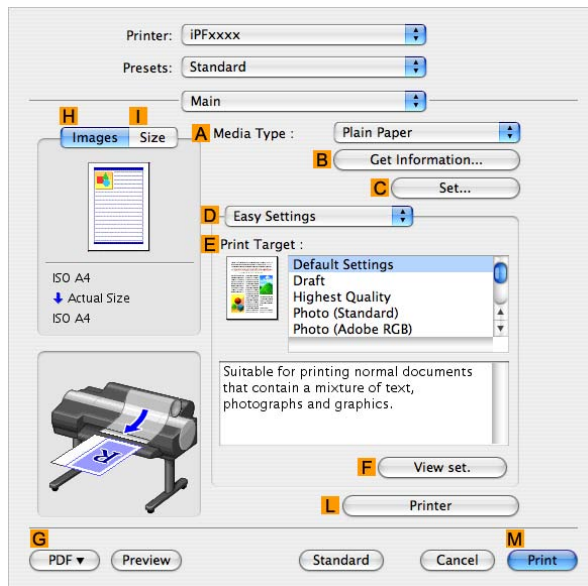

11. Make sure the **C Page Size** setting matches the original size as selected in **C Paper Size** in the **Page Attribute** dialog box-in this case, **ISO A4**.

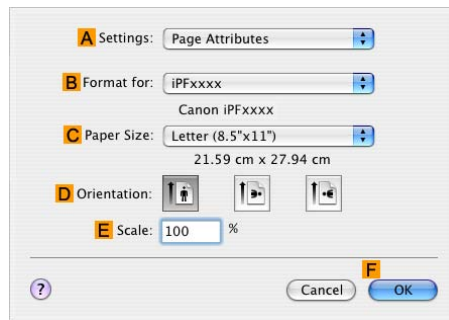

12. Select the **L Rotate Page 90 degrees** check box.
13. Confirm the print settings, and then click **M Print** to start printing.



Note

- For tips on confirming print settings, see “Confirming Print Settings (Mac OS X)”. (→P.493)

Conserving Roll Paper by Rotating Originals 90 Degrees (Mac OS 9)

This topic describes how to conserve roll paper by rotating originals 90 degrees before printing, based on the following example.

- Document: Any type
- Page size: A4 (210.0×297.0 mm)/Letter (8.3 × 11.7 in)
- Paper: Roll
- Paper type: Plain Paper
- Roll width: A3/A4 roll (297.0 mm [11.7 in])

This example illustrates how to rotate an A4 (210.0×297.0 mm)/Letter (8.3 × 11.7 in) original in portrait orientation 90 degrees to fit within the width of A3/A4 roll (297.0 mm [11.7 in]), which enables you to conserve paper.

1. Select the printer in **Chooser**.
2. Choose **Page Setup** from the application menu to display the **Page Attribute** dialog box.

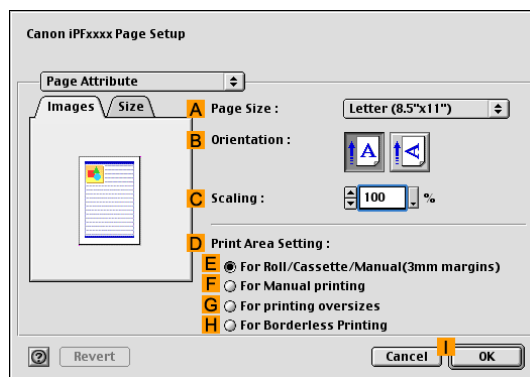

3. In the **A Page Size** list, click the size of the original. In this case, click **ISO A4**.
4. Click **I OK** to close the dialog box.
5. Choose **Print** in the application menu.
6. Make sure the **Main** pane is displayed.

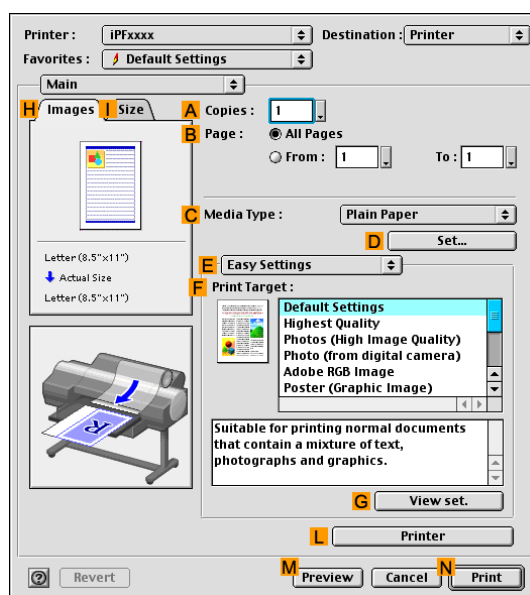

7. In the **C Media Type** list, select the type of paper that is loaded. In this case, click Plain Paper.

8. Access the **Finishing** pane.

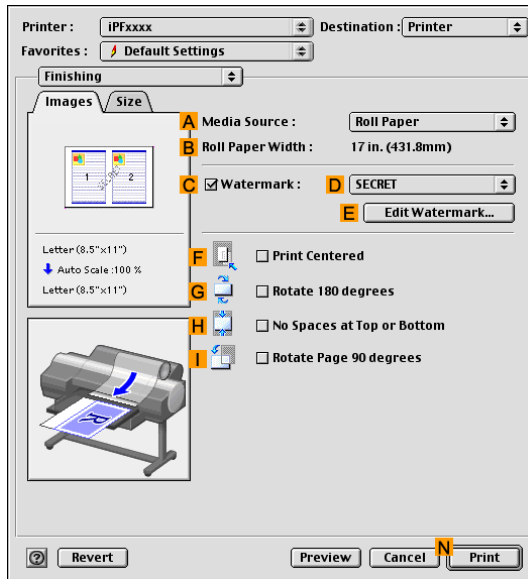

9. Click **Roll Paper** in the **A Media Source** list.

10. Make sure the width of the loaded roll is displayed in the **B Roll Paper Width** list—in this case, **ISO A3/A4 (297.0mm)**.



Note

- If the width of the loaded roll is not displayed in **B Roll Paper Width**, click **L Printer** on the **Main** pane and update the printer information.

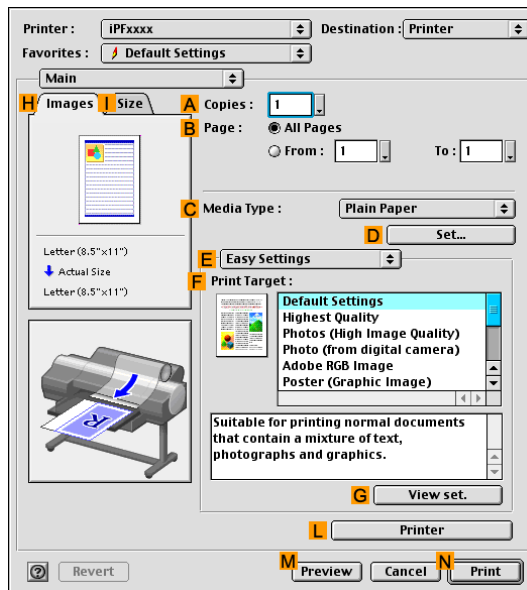

11. Select the **I Rotate Page 90 degrees** check box.

12. Confirm the print settings, and then click **N Print** to start printing.



Note

- For tips on confirming print settings, see “Confirming Print Settings (Mac OS 9)”. (→P.518)

Printing CAD Drawings

☐☐☐ Printing CAD Drawings

Using this printer, you can print fine lines and text clearly and sharply. It's easy to produce highly precise drawings from CAD applications.

For instructions on CAD printing, refer to the following topics, as appropriate for your computer and operating system.

- Printing Line Drawings and Text (Windows) (→P.412)
- Printing Line Drawings and Text (Mac OS X) (→P.414)
- Printing Line Drawings and Text (Mac OS 9) (→P.417)

Printing Line Drawings and Text (Windows)

This topic describes how to print line drawings based on the following example.

- Document: CAD drawing
- Page size: A3 (297.0 × 420.0 mm [11.7 × 16.5 in])
- Paper: Roll
- Paper type: Plain Paper
- Roll paper width: A2/A3 roll (420.0 mm [16.5 in])

1. Choose **Print** in the application menu.
2. Select the printer in the dialog box, and then open the printer driver dialog box. (→P.473)
3. Make sure the **Main** sheet is displayed.

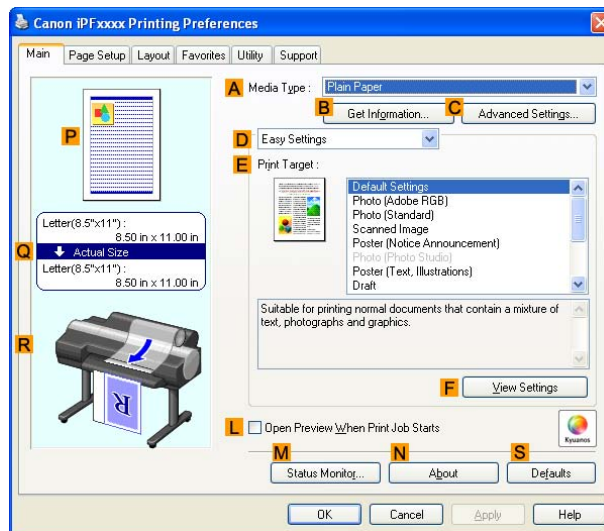

4. In the **A Media Type** list, select the type of paper that is loaded. In this case, click Plain Paper.
5. After confirming that **D Easy Settings** is selected, click **CAD (Line Drawing)** in the **E Print Target** list.



Note

- You can check the settings values selected in the **E Print Target** list by clicking **F View Settings**.

6. Click the **Page Setup** tab to display the **Page Setup** sheet.

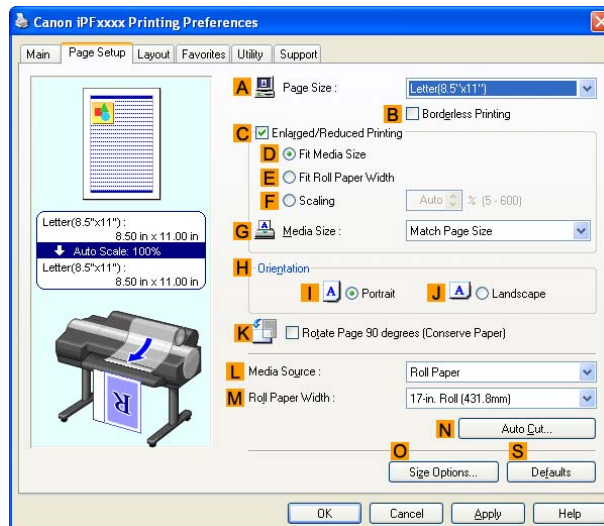

7. In **A Page Size**, click the size of the original as specified in the application software. In this case, click **ISO A3**.
8. Click **Roll Paper** in the **L Media Source** list.
9. Select the width of the loaded roll in the **M Roll Paper Width** list-in this case, **ISO A2/A3 Roll (420.0mm)**.
10. Specify additional printing conditions.
For details on available printing conditions, see “Printer Driver Settings (Windows)”. (→P.441)
11. Confirm the print settings and print as desired.

**Note**

- For tips on confirming print settings, see “Confirming Print Settings (Windows)”. (→P.443)

Printing Line Drawings and Text (Mac OS X)

This topic describes how to print line drawings based on the following example.

- Document: CAD drawing
- Page size: A3 (297.0 × 420.0 mm [11.7 × 16.5 in])
- Paper: Roll
- Paper type: Plain Paper
- Roll paper width: A2/A3 roll (420.0 mm [16.5 in])

1. Choose **Page Setup** in the application menu to display the **Page Attribute** dialog box.

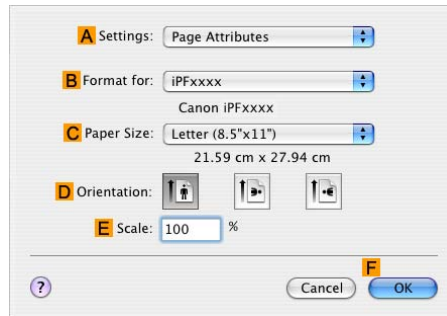

2. Select the printer in the **B Format for** list.

3. In the **C Paper Size** list, click the size of the original. In this case, click **ISO A3**.

4. Click **F OK** to close the dialog box.

5. Choose **Print** in the application menu.

6. Access the **Main** pane.

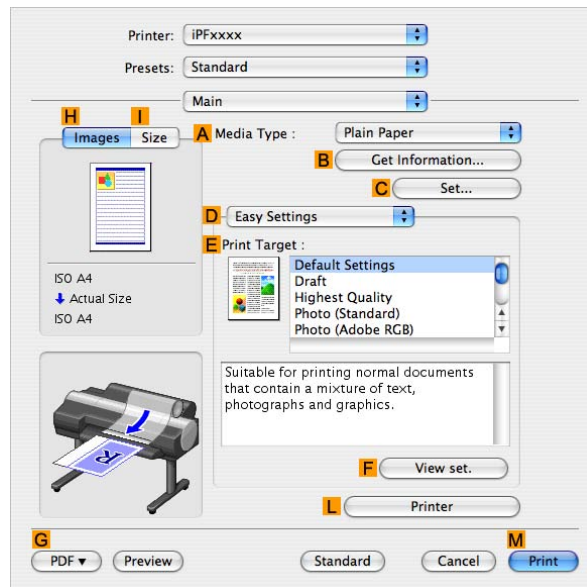

7. In the **A Media Type** list, select the type of paper that is loaded. In this case, click Plain Paper.

8. After confirming that **D Easy Settings** is selected, click **CAD (Line Drawing)** in the **E Print Target** list.



Note

- You can check the settings values selected in the **E Print Target** list by clicking **F View set..**

9. Access the **Page Setup** pane.

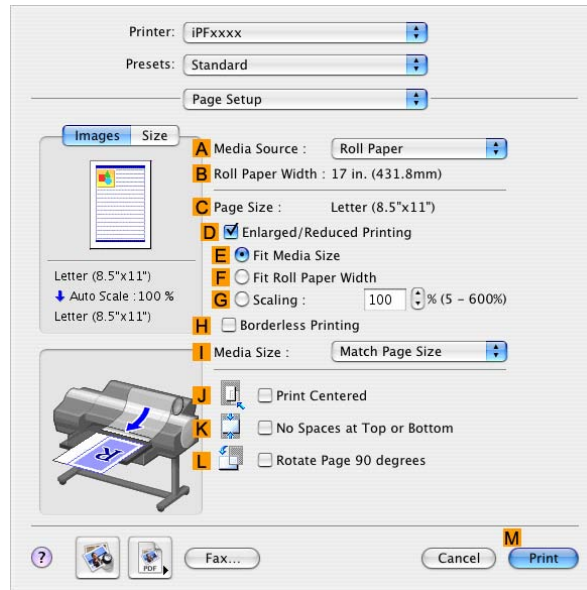

10. Click **Roll Paper** in the **A Media Source** list.

11. Make sure the width of the loaded roll is displayed in the **B Roll Paper Width** list-in this case, **ISO A2/A3 (420.0mm)**.



Note

- If the width of the loaded roll is not displayed in **B Roll Paper Width**, click **L Printer Information** on the **Main** pane and update the printer information.

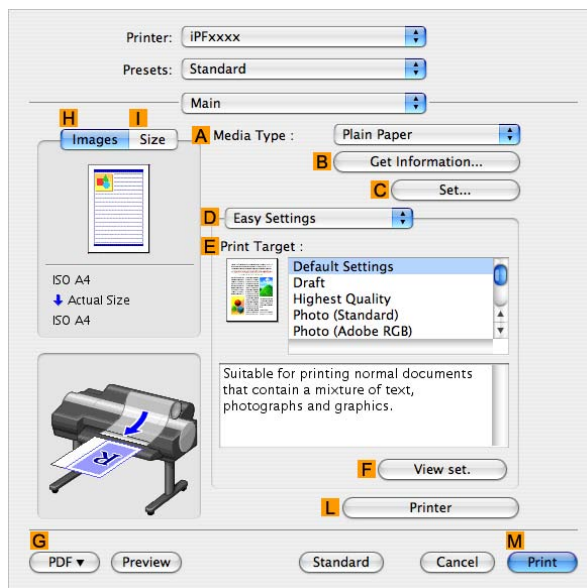

12. Make sure **C Page Size** on the **Page Setup** pane shows the original size as specified in **C Paper Size** in the **Page Attribute** dialog box—in this case, **ISO A3**.

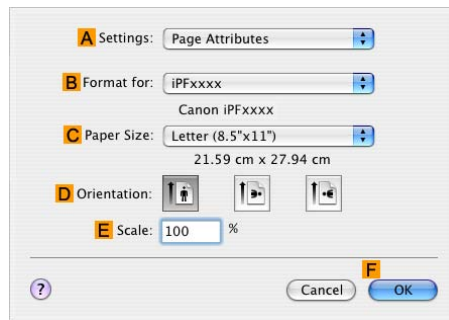

13. Specify additional printing conditions.

For details on available printing conditions, see “Printer Driver Settings (Mac OS X)”. (→P.492)

14. Confirm the print settings, and then click **M Print** to start printing.



Note

- For tips on confirming print settings, see “Confirming Print Settings (Mac OS X)”. (→P.493)

Printing Line Drawings and Text (Mac OS 9)

This topic describes how to print line drawings based on the following example.

- Document: CAD drawing
- Page Size: A3 (297.0×420.0 mm [11.7 × 16.5 in])
- Paper: Sheets (**Manual**)
- Paper type: Plain Paper
- Paper size: A3 (297.0×420.0 mm [11.7 × 16.5 in])

1. Select the printer in **Chooser**.
2. Choose **Page Setup** in the application menu to display the **Page Attribute** dialog box.

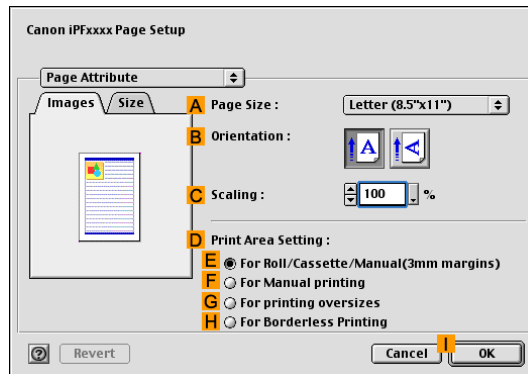

3. In the **A Page Size** list, click the size of the original. In this case, click **ISO A4**.
4. Click **I OK** to close the dialog box.
5. Choose **Print** in the application menu.
6. Make sure the **Main** pane is displayed.

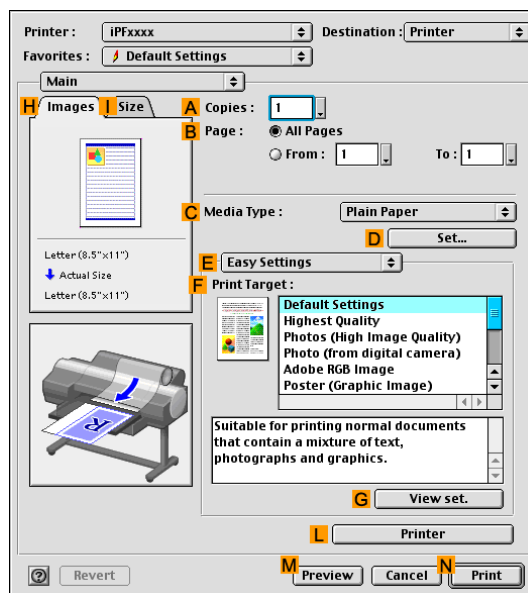

7. In the **C Media Type** list, select the type of paper that is loaded. In this case, click Plain Paper.

- After confirming that **E Easy Settings** is selected, click **CAD (Line Drawing)** in the **F Print Target** list.



Note

- You can check the settings values selected in the **F Print Target** list by clicking **G View set**.

- Access the **Finishing** pane.

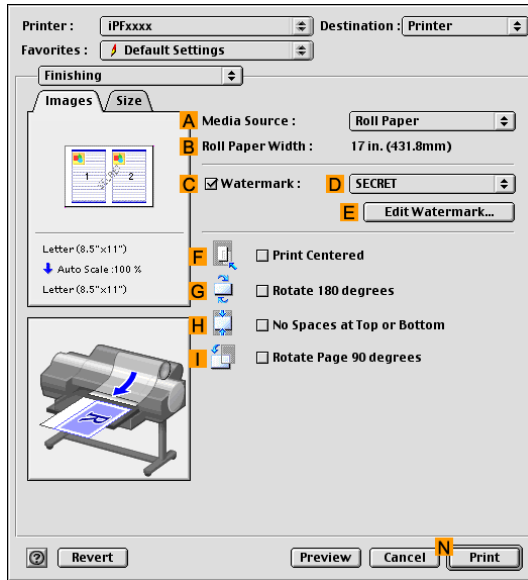

- Click **Manual** in the **A Media Source** list.

- Specify additional printing conditions.

For details on available printing conditions, see “Printer Driver Settings (Mac OS 9)”. (→P.517)

- Confirm the print settings, and then click **N Print** to start printing.



Note

- For tips on confirming print settings, see “Confirming Print Settings (Mac OS 9)”. (→P.518)

Other useful settings

Printing With Watermarks

You can add watermarks (background images) to documents that require special handling.

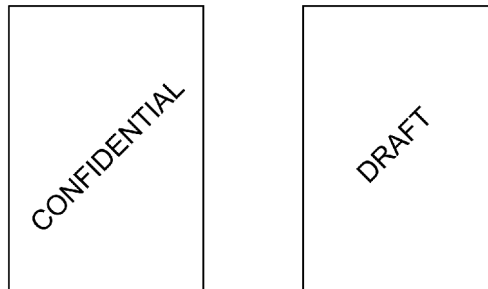

Watermark

Watermarks are applied to all pages of your document.



Important

- Watermarks are not printed if you select poster as the type of page layout.

The following watermarks are provided:

- CONFIDENTIAL (Windows)
- COPY (Windows and Mac OS 9)
- DRAFT (Windows and Mac OS 9)
- FILE COPY (Windows and Mac OS 9)
- FINAL (Windows)
- PRELIMINARY (Windows and Mac OS 9)
- PROOF (Windows)
- TOP SECRET (Windows and Mac OS 9)

You can also create your own watermarks. Specify the following options to customize your watermark.

- Watermark string: Specify the font, size, color, and so on. Surround the watermark with a frame, if desired.
- Watermark position: Specify the position on the page, the angle, and so on.
- Watermark printing method: Specify whether to print the watermark superimposed or under the document image. You can also print the watermark only on the first page, if desired.



Note

- Watermarks are supported in Windows and Mac OS 9.
- In addition to the provided watermarks, you can create up to 50 original watermarks in Windows. In Mac OS 9, you can use up to 50 original watermarks including the watermarks provided.

For detailed instructions on printing with watermarks, refer to the following topics:

- Printing with Watermarks-COPY, FILE COPY, and so on (Windows) (→P.436)
- Printing with Watermarks-COPY, FILE COPY, and so on (Mac OS 9) (→P.438)

☐ Making the Original Orientation Match the Paper Orientation

You can specify the original orientation to match the orientation of the paper for printing.

Orientation

Paper is usually loaded in the printer in portrait orientation. When you have an original in landscape orientation, you can specify the printing orientation so that the original is printed in landscape orientation.

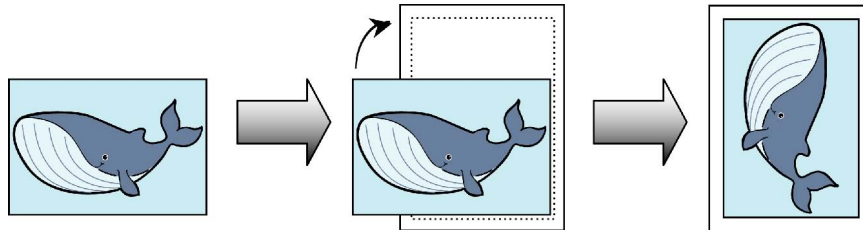

Rotate 180 degrees

The original is rotated 180 degrees to print it upside down.

Mirror

A mirror image of the original is printed.

For instructions on specifying the original orientation before printing, refer to the following topics, as appropriate for your computer and operating system.

- Making the Original Orientation Match the Paper Orientation (Windows) (→P.429)
- Making the Original Orientation Match the Paper Orientation (Mac OS X) (→P.431)
- Making the Original Orientation Match the Paper Orientation (Mac OS 9) (→P.434)

Using Favorites

You can register print settings as “favorites” to reuse settings from a particular job that met your expectations, or settings for a particular page size that you will use repeatedly.

Favorites

Registering a favorite for later use. You can choose the settings you have registered from a list before printing, and you can check the settings details.



Note

- You can also save the favorite settings as files. Using these files is a convenient way to print under the same conditions on another computer. (In Windows and Mac OS 9.)

For instructions on using favorites to print, refer to the following topics, as appropriate for your computer and operating system.

- Using Favorites (Windows) (→P.448)
- Using Favorites (Mac OS X) (→P.506)
- Using Favorites (Mac OS 9) (→P.529)

Cutting Roll Paper After Printing

Roll paper can be automatically cut after printing.



Note

- It may not be possible to cut certain types of paper, such as adhesive paper. For details on types of paper that cannot be used with the auto cut feature, see the Paper Reference Guide. (→P.108)

Automatic Cutting

Roll paper is cut automatically after printing. If you prefer, you can print continuously without cutting the roll, or you can print a cut line.

For instructions on cutting roll paper after printing, refer to the following topics, as appropriate for your computer and operating system.

- Cutting Roll Paper After Printing (Windows) (→P.424)
- Cutting Roll Paper After Printing (Mac OS X) (→P.425)
- Cutting Roll Paper After Printing (Mac OS 9) (→P.427)

Printing from Photoshop

You can print images in the Adobe RGB color space that you have created in Photoshop, the Adobe Systems photo retouching application. Using the dedicated Photoshop printer driver plug-in (provided with the printer) makes it easy to print Adobe RGB images more attractively.

- Using the Plug-in to Print (→P.422)
- Using the Printer Driver to Print (→P.422)

Using the Plug-in to Print

The imagePROGRAF Print Plug-In for Photoshop is a dedicated plug-in provided with the printer that you can load in Photoshop and customize for your printing needs. By using the plug-in, you can print while preserving the 16-bit RGB data from Photoshop without losing the exceptional color gradations of original image. Some of the settings and customizations available in the plug-in are as follows.

- Automatic detection of the color space (sRGB or Adobe RGB) for automatic selection of the optimal profile. This feature eliminates the need to complete intricate settings when printing Adobe RGB images.
- Advanced gray adjustment, including adjustment of tone curves, in addition to an array of standard adjustments for color balance, brightness, contrast, highlight, and shadow.
- Fine-tune color tones in Photoshop while viewing a preview that accurately reproduces printing results.
- With print log management, you can save and load setting parameters from past print jobs.



Note

- imagePROGRAF Print Plug-In for Photoshop for Windows and Macintosh are provided with the printer.

For instructions and details on which versions of Photoshop are compatible with the imagePROGRAF Print Plug-In for Photoshop, refer to the following topics, as appropriate for your computer and operating system.

- imagePROGRAF Print Plug-In for Photoshop Guide (Windows)
- imagePROGRAF Print Plug-In for Photoshop Guide (Macintosh)

Using the Printer Driver to Print

The printer driver offers the following settings and adjustments.

- Choose the standard sRGB color space or Adobe RGB as desired.
- Adjust the color balance, brightness, contrast, saturation, and gray levels.

For instructions on using the printer driver to print Adobe RGB images created in Photoshop, refer to the following topics, as appropriate for your computer and operating system.

- Printing Adobe RGB Images (Windows) (→P.465)
- Printing Adobe RGB Images (Mac OS X) (→P.507)
- Printing Adobe RGB Images (Mac OS 9) (→P.531)

Using PosterArtist to Compose Originals

You can print a variety of source documents from word-processing or spreadsheet programs or screen shots from web browsers after composing an original with them using PosterArtist.



Important

- PosterArtist (sold separately) must be installed to use this function.

Edit Using PosterArtist

PosterArtist offers a wide range of features, including features to insert source documents in posters and compose an original with them.

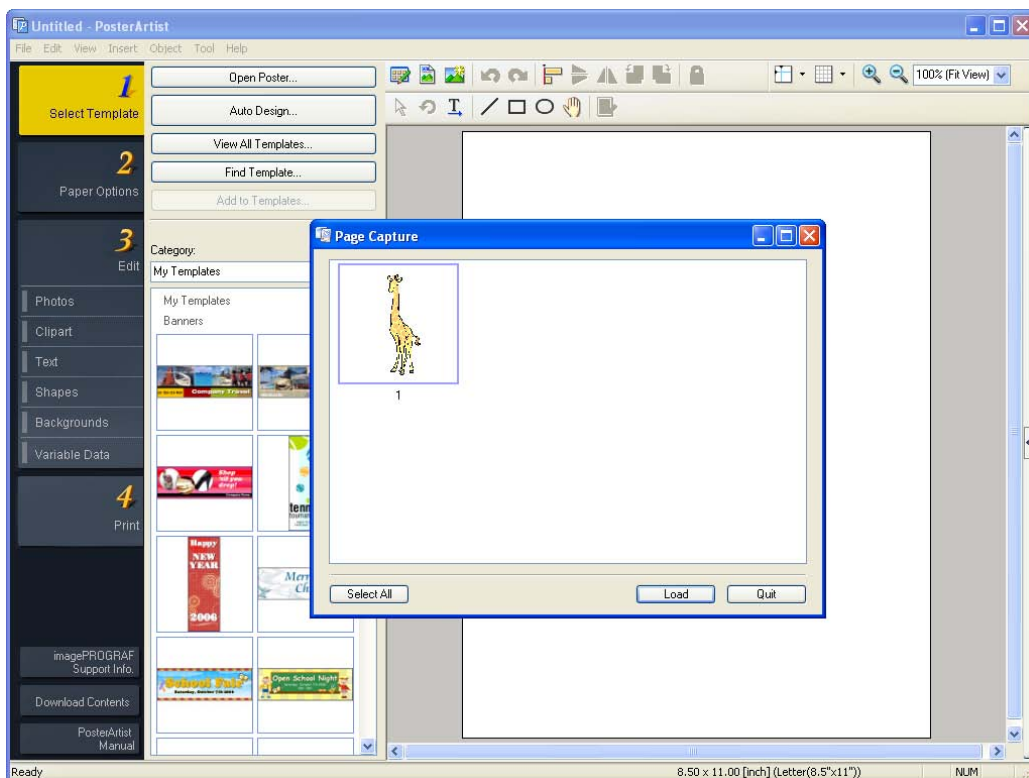

Important

- This function is only supported in Windows.

For detailed instructions on editing with PosterArtist, refer to the following topic:

- Using PosterArtist to Compose Originals (Windows) (→P.463)

☐ Cutting Roll Paper After Printing (Windows)

This topic describes how to cut roll paper automatically (using the auto cut function) after printing, as well as how to print a cut line to cut the paper manually.



Note

- Auto cut function is activated on the printer by factory default and when the printer driver is installed. Follow the steps below to reactivate the function after it is disabled, or to change the setting for printing a cut line instead.

1. Choose **Print** in the application menu.
2. Select the printer in the dialog box, and then display the printer driver dialog box. (→P.473)
3. Click the **Page Setup** tab to display the **Page Setup** sheet.

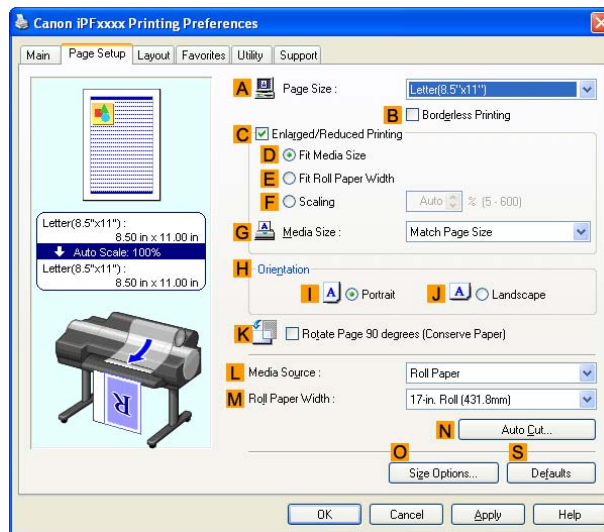

4. Click **Roll Paper** in the **L Media Source** list.
5. Click **N Auto Cut** to display the **Automatic Cutting Settings** dialog box.

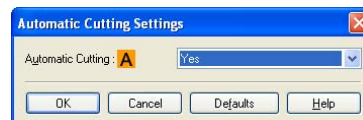

6. To enable automatic cutting, click **Yes** in the **A Automatic Cutting** list. If you prefer to cut the paper later yourself, click **Print Cut Guideline**.
7. Click **OK** to close the **Automatic Cutting Settings** dialog box.
8. Confirm the print settings and print as desired.



Note

- For tips on confirming print settings, see “Confirming Print Settings (Windows)”. (→P.443)

Roll paper will be automatically cut after printing.

☰ Cutting Roll Paper After Printing (Mac OS X)

This topic describes how to cut roll paper automatically (using the auto cut function) after printing, as well as how to print a cut line to cut the paper manually.



Note

- The auto cut function is activated on the printer by factory default and when the printer driver is installed. Follow the steps below to reactivate the function once disabled, or select the setting for printing a cut guideline instead.

1. Choose **Page Setup** in the application menu to display the **Page Attribute** dialog box.

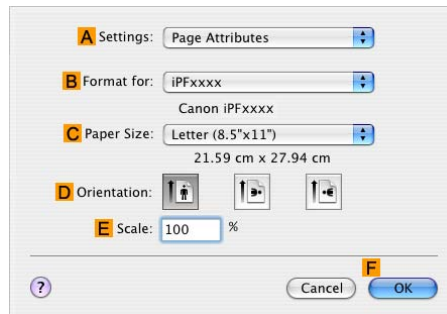

2. Select the printer in the **B Format for** list.
3. Choose the original size in the **C Paper Size** list.
4. Click **F OK** to close the dialog box.
5. Choose **Print** in the application menu.
6. Access the **Page Setup** pane.

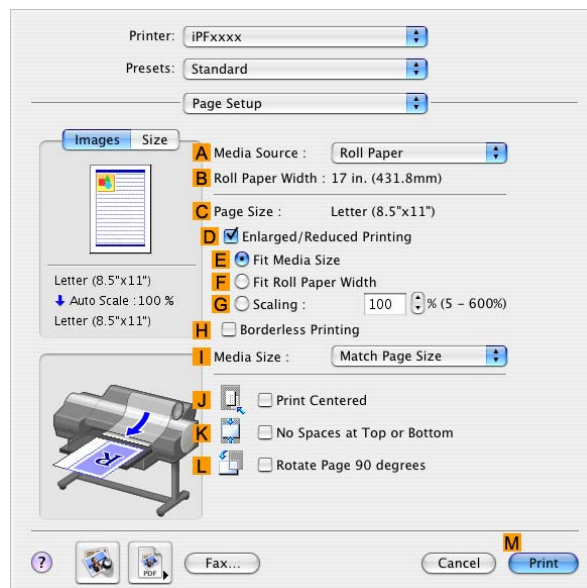

7. Click **Roll Paper** in the **A Media Source** list.

8. Access the **Main** pane.

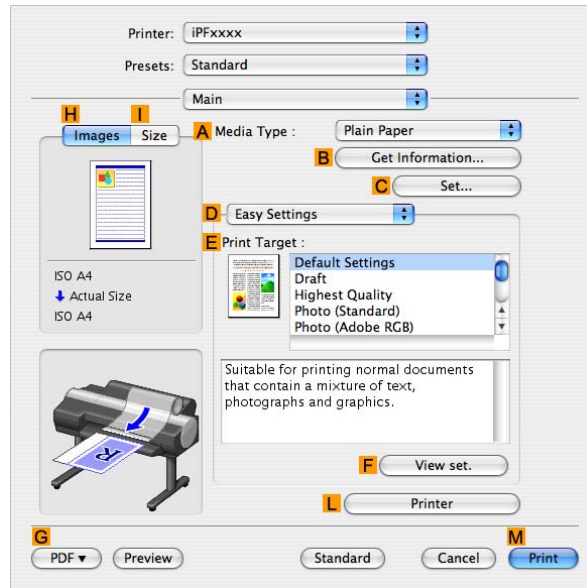

9. In the **A Media Type** list, select the type of paper that is loaded.

10. Click **C Set** to display the **Media Detailed Settings** dialog box.

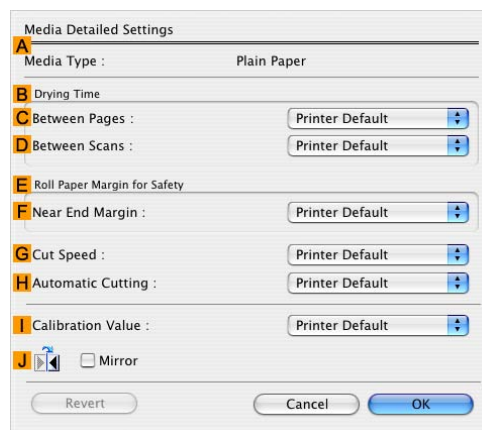

11. To enable automatic cutting, click **Printer Default** in the **H Automatic Cutting** list. If you prefer to cut the paper later yourself, click **Print Cut Guideline**.



Important

- If the automatic cut function has been deactivated on the printer, change the auto cut setting on the printer Control Panel.

12. Click **OK** to close the **Media Detailed Settings** dialog box.

13. Confirm the print settings, and click **M Print** to start printing.



Note

- For tips on confirming print settings, see “Confirming Print Settings (Mac OS X)”. (→P.493)

Cutting Roll Paper After Printing (Mac OS 9)

This topic describes how to cut roll paper automatically (using the auto cut function) after printing, as well as how to print a cut line to cut the paper manually.



Note

- The auto cut function is activated on the printer by factory default and when the printer driver is installed. Follow the steps below to reactivate the function once disabled, or select the setting for printing a cut guideline instead.

1. Select the printer in **Chooser**.
2. Choose **Page Setup** from the application menu to display the **Page Attribute** dialog box.

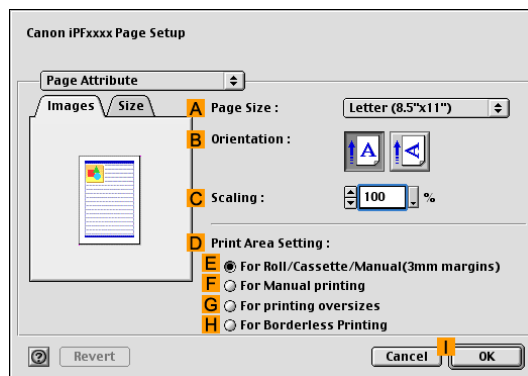

3. Choose the original size in the **A Page Size** list.
4. Click **I OK** to close the dialog box.
5. Choose **Print** in the application menu.
6. Access the **Finishing** pane.

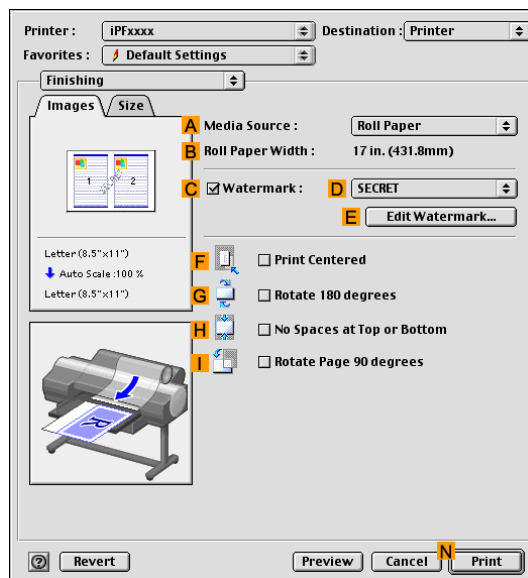

7. Make sure **Roll Paper** is selected in **A Media Source**.

8. Access the **Main** pane.

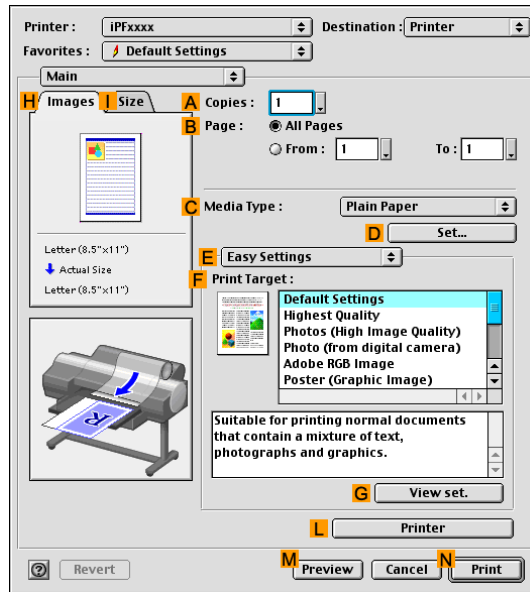

9. In the **C Media Type** list, select the type of paper that is loaded.

10. Click **D Set** to display the **Media Detailed Settings** dialog box.

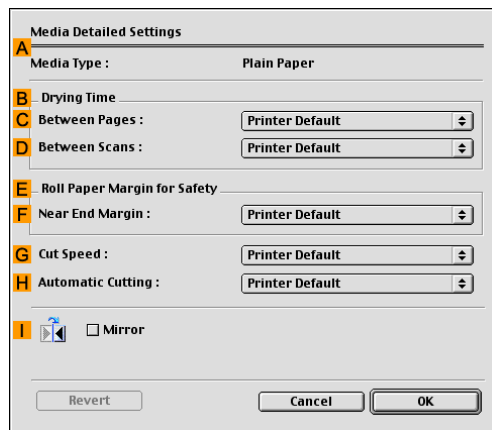

11. To enable automatic cutting, click **Printer Default** in the **H Automatic Cutting** list. If you prefer to cut the paper later yourself, click **Print Cut Guideline**.



Important

- If the automatic cut function has been deactivated on the printer, change the auto cut setting on the printer Control Panel.

12. Click **OK** to close the **Media Detailed Settings** dialog box.

13. Confirm the print settings, and then click **N Print** to start printing.



Note

- For tips on confirming print settings, see “Confirming Print Settings (Mac OS 9)”. (→P.518)

☐ Making the Original Orientation Match the Paper Orientation (Windows)

This topic describes how to print an original in landscape orientation after matching the paper orientation, based on the following example.

- Document: An original in landscape orientation
- Page size: A4 (210.0 × 297.0 mm)/Letter (8.3 × 11.7 in)
- Paper: Roll
- Paper type: Plain Paper
- Roll paper width: A2/A3 roll (420.0 mm [16.5 in])

1. Choose **Print** in the application menu.
2. Select the printer in the dialog box, and then open the printer driver dialog box. (→P.473)
3. Make sure the **Main** sheet is displayed.

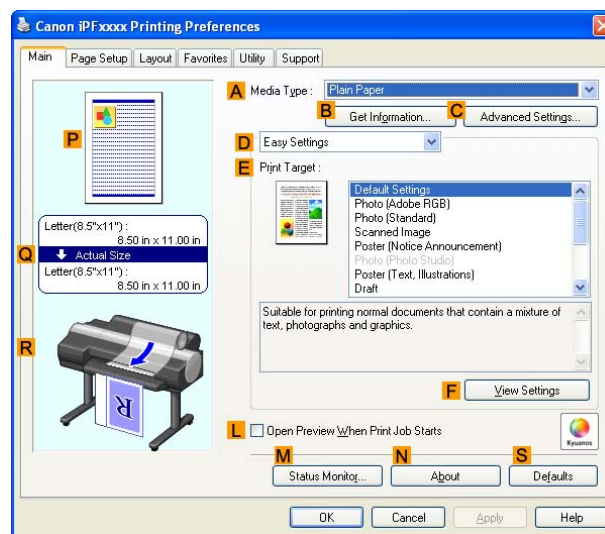

4. In the **A Media Type** list, select the type of paper that is loaded. In this case, click Plain Paper.
5. Select the printing application in the **E Print Target** list.
6. Click the **Page Setup** tab to display the **Page Setup** sheet.

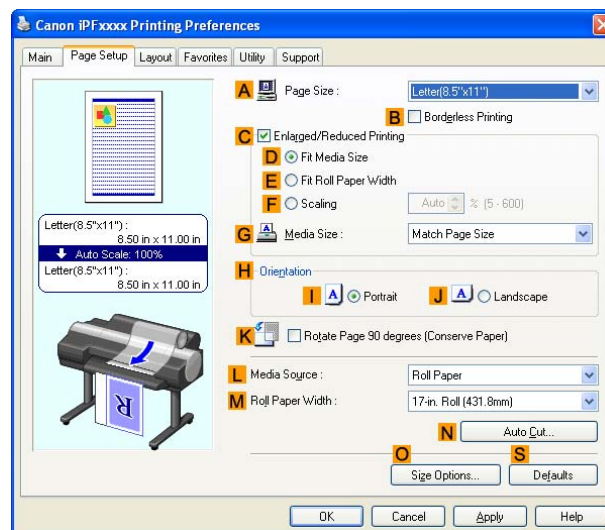

Other useful settings

7. In the **A Page Size** list, click the size of the original as specified in the application. In this case, click **ISO A4** or **Letter (8.5"x11")**.
8. In **H Orientation**, click **J Landscape**.
9. Click **Roll Paper** in the **L Media Source** list.
10. Select the width of the loaded roll in the **M Roll Paper Width** list-in this case, **ISO A2/A3 Roll (420.0mm)**.
11. Confirm the print settings and print as desired.



Note

- For tips on confirming print settings, see “Confirming Print Settings (Windows)”. (→P.443)

☐ Making the Original Orientation Match the Paper Orientation (Mac OS X)

This topic describes how to print an original in landscape orientation after matching the paper orientation, based on the following example.

- Document: An original in landscape orientation
- Page size: A4 (210.0 × 297.0 mm)/Letter (8.3 × 11.7 in)
- Paper: Roll
- Paper type: Plain Paper
- Roll paper width: A2/A3 roll (420.0 mm [16.5 in])

1. Choose **Page Setup** in the application menu to display the **Page Attribute** dialog box.

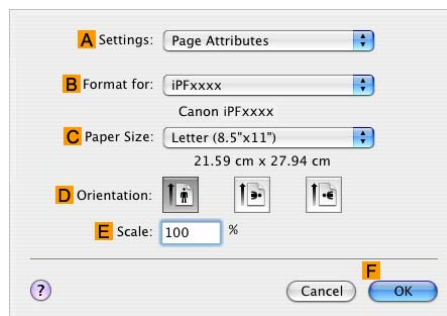

2. Select the printer in the **B Format for** list.

3. In the **C Paper Size**, click the size of the original. In this case, click **ISO A4**.

4. In **D Orientation**, click the icon of the document in landscape orientation.

5. Click **F OK** to close the dialog box.

6. Choose **Print** in the application menu.

7. Access the **Main** pane.

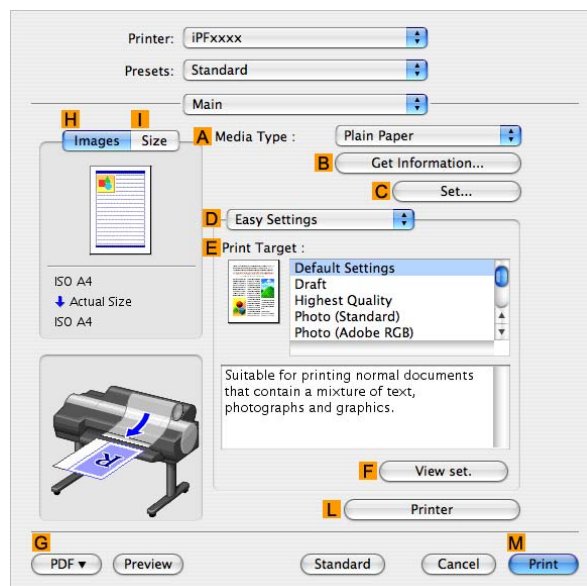

8. In the **A Media Type** list, select the type of paper that is loaded. In this case, click **Plain Paper**.

9. Select the printing application in the **E Print Target** list.

10. Access the **Page Setup** pane.

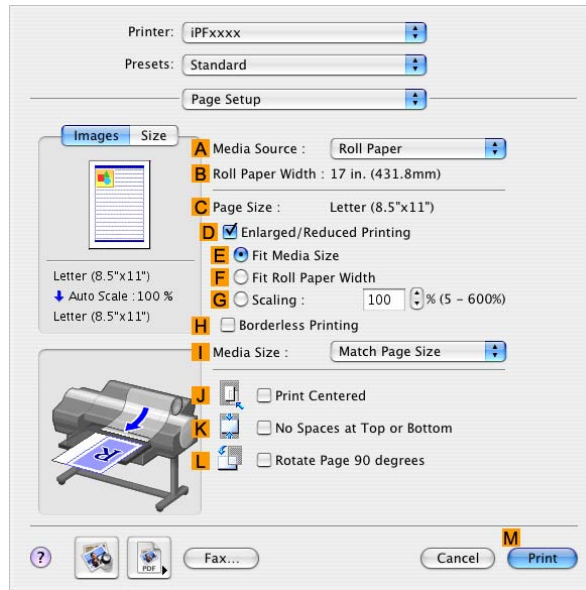

11. Click **Roll Paper** in the **A Media Source** list.

12. Make sure the width of the loaded roll is displayed in the **B Roll Paper Width** list-in this case, **ISO A2/A3 (420.0mm)**.



Note

- If the width of the loaded roll is not displayed in **B Roll Paper Width**, click **L Printer Information** on the **Main** pane and update the printer information.

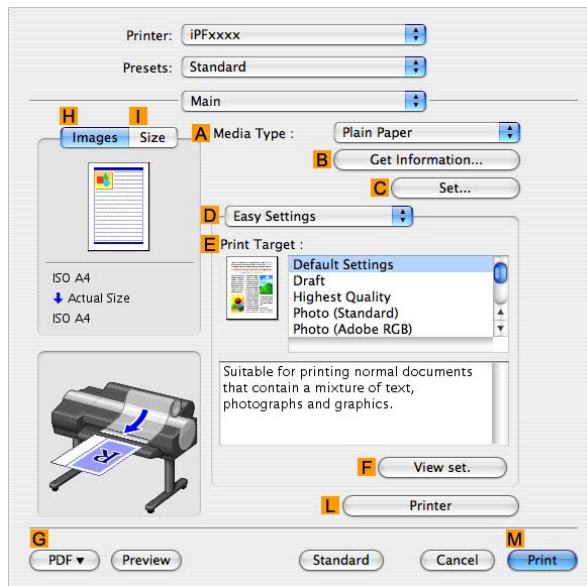

13. Make sure the **C Page Size** setting matches the original size as selected in **C Paper Size** in the **Page Attribute** dialog box-in this case, **ISO A4**.

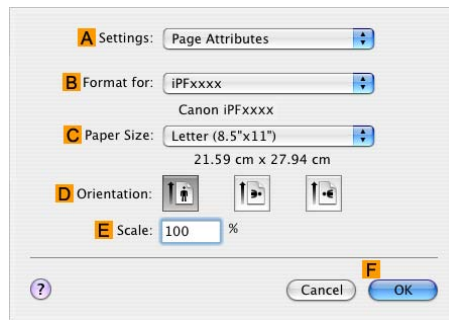

14. Confirm the print settings, and then click **M Print** to start printing.



Note

- For tips on confirming print settings, see “Confirming Print Settings (Mac OS X)”. (→P.493)

☐ Making the Original Orientation Match the Paper Orientation (Mac OS 9)

This topic describes how to print an original in landscape orientation after matching the paper orientation, based on the following example.

- Document: An original in landscape orientation
- Page size: A4 (210.0 × 297.0 mm)/Letter (8.3 × 11.7 in)
- Paper: Roll
- Paper type: Plain Paper
- Roll paper width: A2/A3 roll (420.0 mm [16.5 in])

1. Select the printer in **Chooser**.
2. Choose **Page Setup** from the application menu to display the **Page Attribute** dialog box.

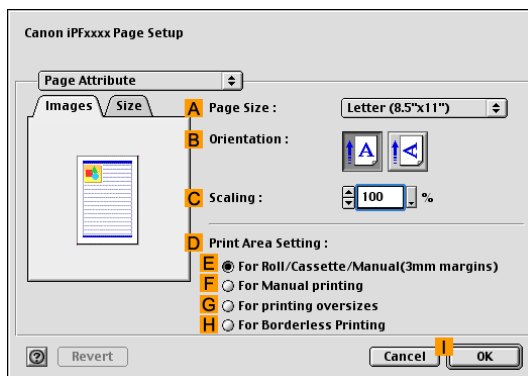

3. In **A Page Size**, click the size of the original. In this case, click **ISO A4**.
4. In **B Orientation**, click the icon of the document in landscape orientation.
5. Click **I OK** to close the dialog box.
6. Choose **Print** in the application menu.
7. Make sure the **Main** pane is displayed.

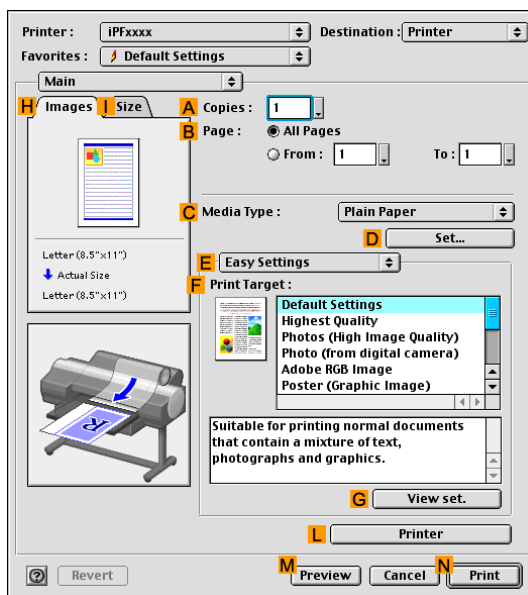

8. In the **C Media Type** list, select the type of paper that is loaded. In this case, click Plain Paper.

9. Select the printing application in the **F Print Target** list.
10. Access the **Finishing** pane.

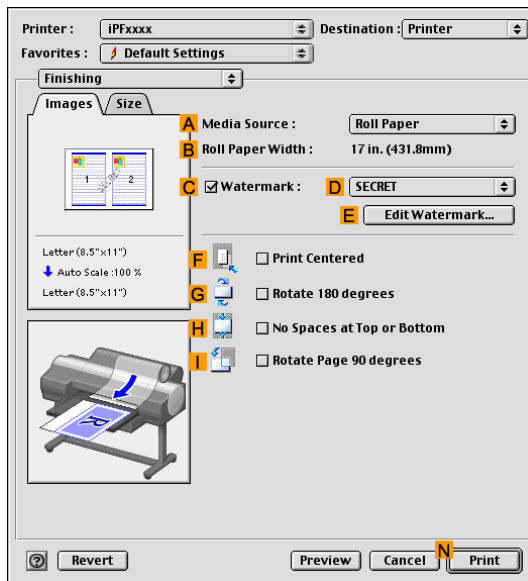

11. Click **Roll Paper** in the **A Media Source** list.
12. Make sure the width of the loaded roll is displayed in the **B Roll Paper Width** list—in this case, **ISO A2/A3 (420.0mm)**.



Note

- If the width of the loaded roll is not displayed in **B Roll Paper Width**, click **L Printer** on the **Main** pane and update the printer information.

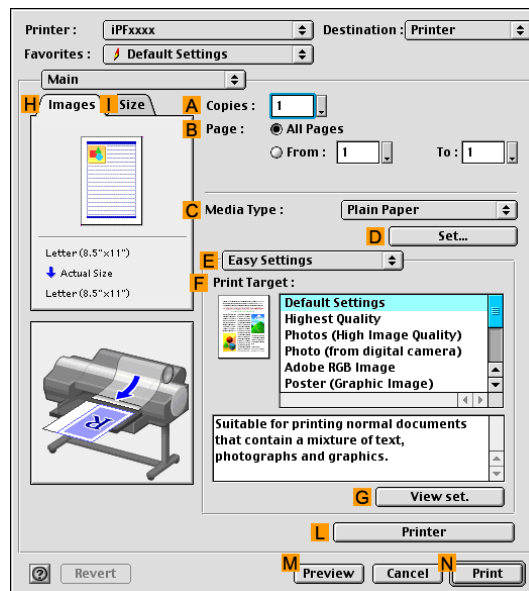

13. Confirm the print settings, and then click **N Print** to start printing.



Note

- For tips on confirming print settings, see “Confirming Print Settings (Mac OS 9)”. (→P.518)

Printing with Watermarks-COPY, FILE COPY, and so on (Windows)

This topic describes how to print office documents with a watermark (in this case, “FILE COPY”) based on the following example.

- Document: CAD drawing
- Page size: A2 (420.0 × 594.0 mm [16.5 × 23.4 in])
- Paper: Roll
- Paper type: Plain Paper
- Roll paper width: A2/A3 roll (420.0 mm [16.5 in])

1. Choose **Print** in the application menu.
2. Select the printer in the dialog box, and then open the printer driver dialog box. (→P.473)
3. Make sure the **Main** sheet is displayed.

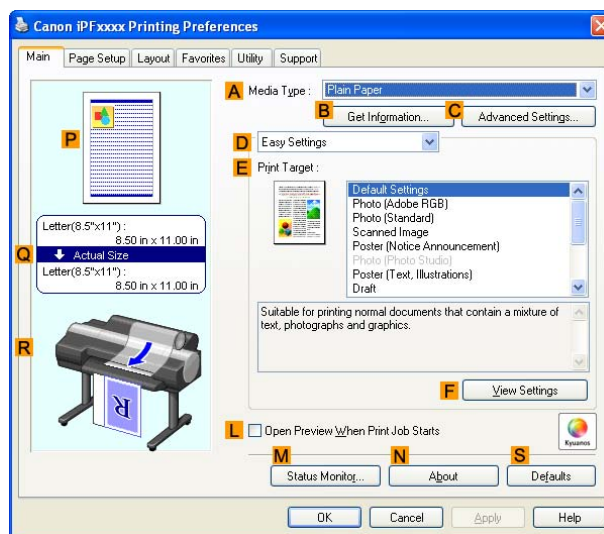

4. In the **A Media Type** list, select the type of paper that is loaded. In this case, click Plain Paper.
5. After confirming that **D Easy Settings** is selected, click **CAD (Line Drawing)** in the **E Print Target** list.



Note

- You can check the settings values selected in the **E Print Target** list by clicking **F View Settings**.

6. Click the **Page Setup** tab to display the **Page Setup** sheet.

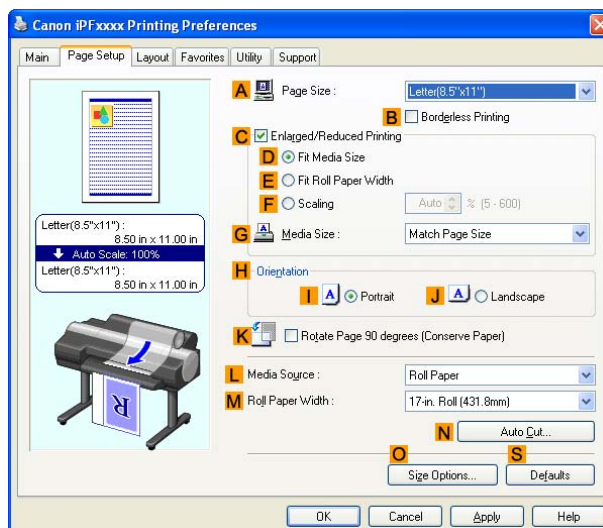

7. In **A Page Size**, click the size of the original as specified in the application software. In this case, click **ISO A4** or **Letter (8.5"x11")**.
8. Click **Roll Paper** in the **L Media Source** list.
9. Select the width of the loaded roll in the **M Roll Paper Width** list-in this case, **ISO A2/A3 Roll (420.0mm)**.
10. Click the **Layout** tab to display the **Layout** sheet.

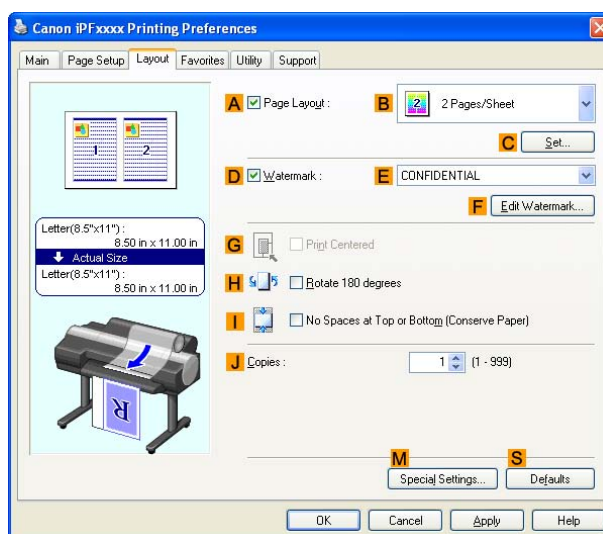

11. Select the **D Watermark** check box.
12. Click **FILE COPY** in the **E Watermarks** list.



Note

- To create your own, original watermark, click **F Edit Watermark**. Refer to the printer driver help for instructions on modifying watermarks to create your own.

13. Confirm the print settings and print as desired.



Note

- For tips on confirming print settings, see “Confirming Print Settings (Windows)”. (→P.443)

Printing with Watermarks-COPY, FILE COPY, and so on (Mac OS 9)

This topic describes how to print office documents with a watermark (in this case, "FILE COPY") based on the following example.

- Document: CAD drawing
- Page size: A2 (420.0 × 594.0 mm [16.5 × 23.4 in])
- Paper: Roll
- Paper type: Plain Paper
- Roll paper width: A2/A3 roll (420.0 mm [16.5 in])

1. Select the printer in **Chooser**.
2. Choose **Page Setup** from the application menu to display the **Page Attribute** dialog box.

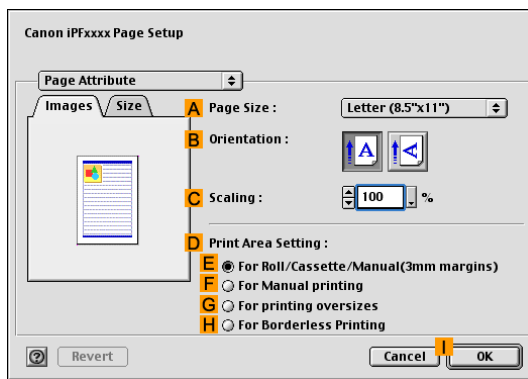

3. In the **A** Page Size list, click the size of the original. In this case, click **ISO A2**.
4. Click **I** OK to close the dialog box.
5. Choose **Print** in the application menu.
6. Make sure the **Main** pane is displayed.

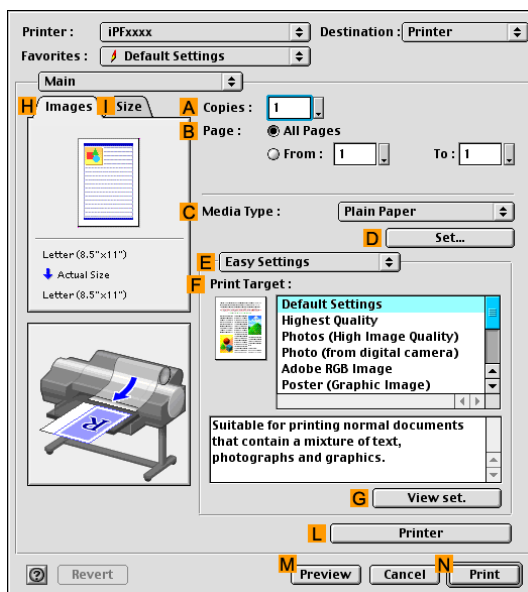

7. In the **C Media Type** list, select the type of paper that is loaded. In this case, click Plain Paper.
8. After confirming that **E Easy Settings** is selected, click **CAD (Line Drawing)** in the **F Print Target** list.



Note

- You can check the settings values selected in the **F Print Target** list by clicking **G View set..**

9. Access the **Finishing** pane.

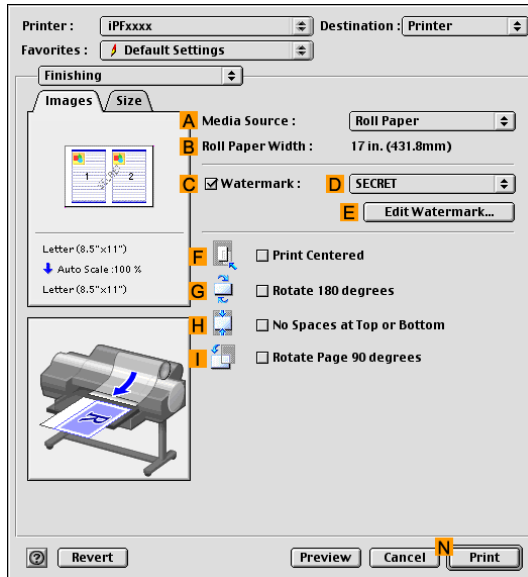

10. Click **Roll Paper** in the **A Media Source** list.
11. Make sure the width of the loaded roll is displayed in the **B Roll Paper Width** list-in this case, **ISO A2/A3 (420.0mm)**.



Note

- If the width of the loaded roll is not displayed in **B Roll Paper Width**, click **L Printer** on the **Main** pane and update the printer information.

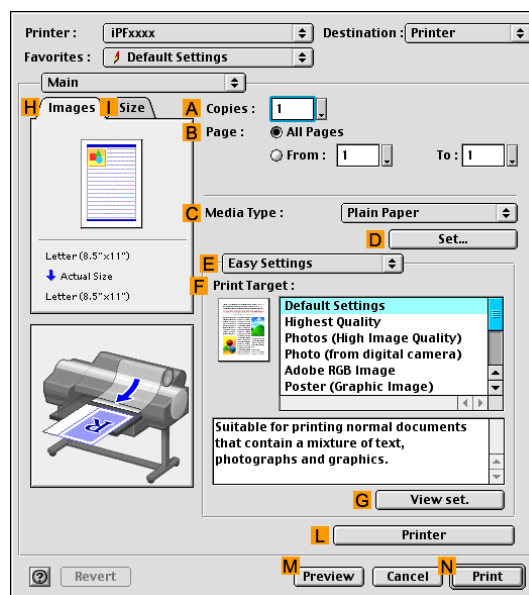

Other useful settings

12. Select the **C Watermark** check box.

13. Click **FILE COPY** in the **D Watermarks** list.



Note

- To create your own, original watermark, click **E Edit Watermark**. Refer to the printer driver help for instructions on modifying watermarks to create your own.

14. Specify additional printing conditions.

For details on available printing conditions, see “Printer Driver Settings (Mac OS 9)”. (→P.517)

15. Confirm the print settings, and then click **N Print** to start printing.



Note

- For tips on confirming print settings, see “Confirming Print Settings (Mac OS 9)”. (→P.518)

Software

Windows

Printer Driver Settings (Windows)

For instructions on accessing the Windows printer driver, refer to the following topics.

- Accessing the Printer Driver Dialog Box from Applications (Windows) (→P.473)
- Accessing the Printer Driver Dialog Box from the Operating System Menu (Windows) (→P.475)

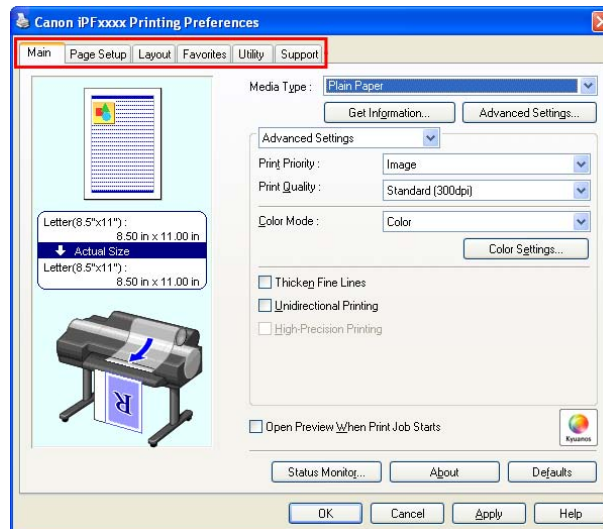

For information on the Windows printer driver settings, refer to the following topics.

- Main Sheet (Windows) (→P.450)

You can specify the media type, color processing, print quality, print preview, and other settings. Choose **Easy Settings** to specify basic print settings based on the printing application or **Advanced Settings** to complete more detailed settings as desired.

 - Media Detailed Settings Dialog Box (Windows) (→P.486)
 - View Settings Dialog Box for the Printing Application (Windows) (→P.491)
 - Color Settings Sheet: Color (Windows) (→P.477)
 - Color Settings Sheet: Monochrome (Windows) (→P.483)
 - Gray Adjustment Sheet (Windows) (→P.458)
- Page Setup Sheet (Windows) (→P.454)

You can specify the page size of the original, borderless printing, enlargement or reduction, the orientation, the media size and source, and automatic cutting.

 - Media Size Options Dialog Box (Windows) (→P.487)

- Layout Sheet (Windows) (→P.456)

You can specify the page layout, watermarks, the orientation, the number of copies, and print processing options.

- Special Settings Dialog Box (Windows) (→P.490)

- Favorites Sheet (Windows) (→P.459)

Groups of print settings you select on each sheet can be saved in a favorite. Favorites you have added can be edited or used at the time of printing as desired.

- Utility Sheet (Windows) (→P.460)

You can specify settings related to maintenance for the Printhead and feed amount, as well as settings for **Color imageRUNNER Enlargement Copy**.

- Support Sheet (Windows) (→P.461)

You can view support information and the user's manual.

- Device Settings Sheet (Windows) (→P.462)

You can display settings for optional equipment installed on the printer and see the printer driver version.

imagePROGRAF Free Layout is a feature for freely arranging originals from various source applications on a single page as desired before printing. For details, see Free Layout Guide .

Color imageRUNNER Enlargement Copy is a feature for automatic enlargement and printing of scanned originals from a **Color imageRUNNER**. For details, see Color imageRUNNER Enlargement Copy Guide .

☐ Confirming Print Settings (Windows)

There are two ways to confirm the print settings, as follows.

- Checking a preview of the settings (→P.443)
- Checking a print preview (→P.444)

Checking a preview of the settings

A preview of the settings is displayed on the left side of the **Main**, **Page Setup**, and **Layout** sheets. By checking images and numerical values in the preview, you can confirm current settings for the page size, orientation, media source, layout, and so on.

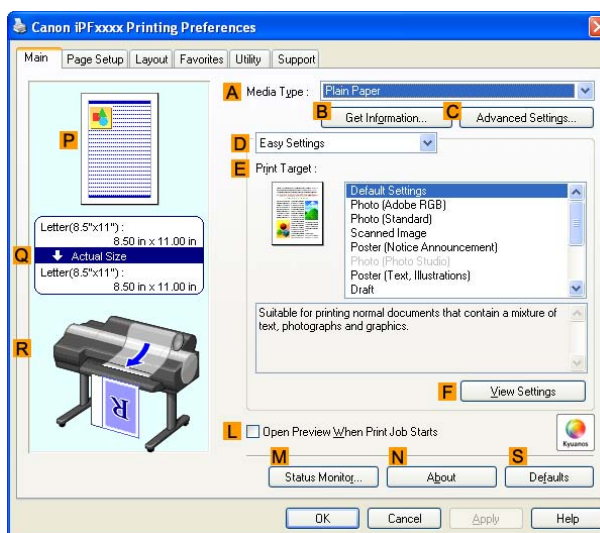

Display Area	Information Displayed
Top illustrations	Illustrations indicate the orientation, page layout, borderless printing selection, color mode, and other settings information.
Middle, bordered area	The page size, paper size, and method and percentage of enlargement or reduction are displayed.
Bottom illustrations	Illustrations indicate the media source, orientation, borderless printing selection, and other settings information.



Note

- To confirm the **Print Target** specified in **Easy Settings**, click **F View Settings** on the **Main** sheet to display the **View Settings** dialog box.

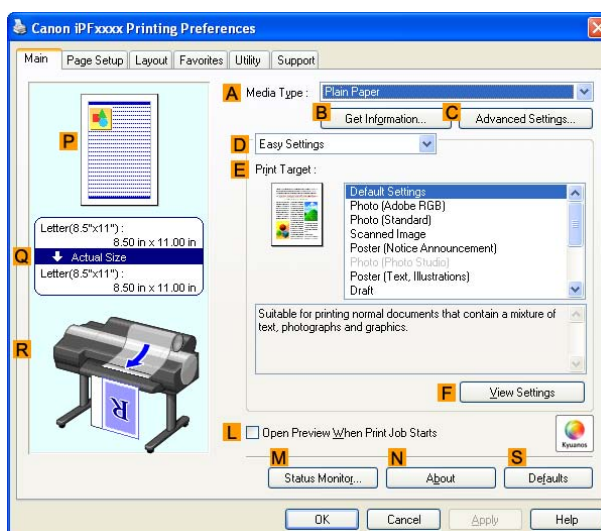

Checking a print preview

You can check an image of the original just as it will be printed.

When you activate this feature, PageComposer is launched before printing. Confirming how documents will be printed this way helps prevent printing errors.

For details on print previews, see “Previewing Images Before Printing (Windows)”. (→P.445)

Previewing Images Before Printing (Windows)

This topic describes how to preview images of print jobs before actually printing them.

1. Choose **Print** in the application menu.
2. Select the printer in the dialog box, and then display the printer driver dialog box. (→P.473)
3. Make sure the **Main** sheet is displayed.

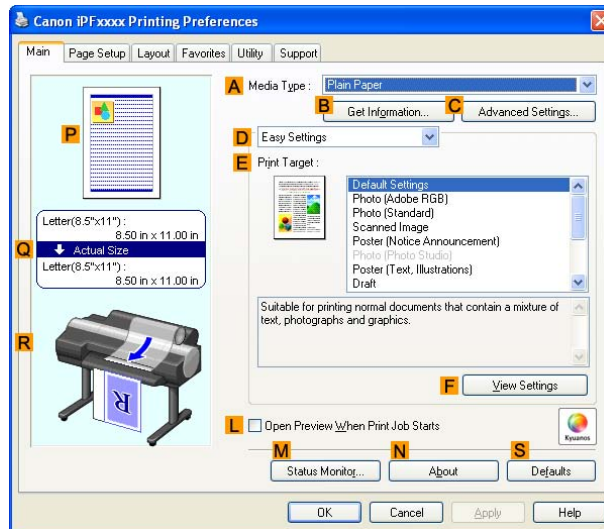

4. Select the **L Open Preview When Print Job Starts** check box.
5. When you attempt to print, the PageComposer window is displayed. (At this point, the document will not be printed yet.)
6. In the PageComposer editing window, select the document to print and open the **Print Preview** window.
7. After confirming that the layout is just as you expected, close the **Print Preview** window.
8. In the PageComposer editing window, make sure the document to print is selected. Choose **Print** from the **File** menu.

Paper Information on Printer Dialog Box (Windows)

On the **Paper Information on Printer** dialog box, you can obtain information on the paper in the printer and configure printer driver settings for the media source and media type.

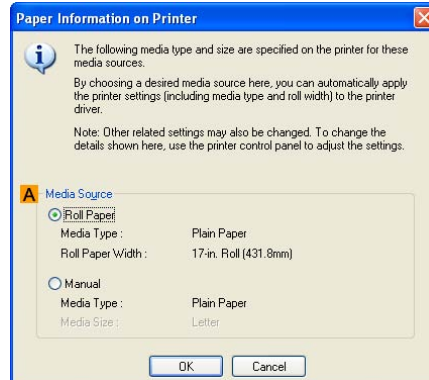

Note

- To display the **Paper Information on Printer** dialog box, on the **Main Sheet (Windows)** (→P.450) , click **Get Information by Media Type**.

Setting Item	Description
 Media Source	Shows the Media Source supported by the printer, as well as information about the loaded paper. To update the Media Source and media type settings in the printer driver, select the desired Media Source option and click OK .

☐ Settings Summaries Dialog Box (Windows)

The **Settings Summaries** dialog box enables you to confirm the settings for the **Main**, **Page Setup**, **Layout**, and **Favorites** sheets.

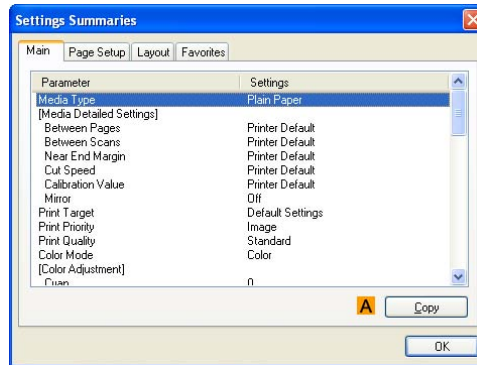

Button	Corresponding Utility
 Copy	Click to copy the settings information to the clipboard. You can paste the settings information into a file created with a text editor or similar application.

Using Favorites (Windows)

This topic describes how to register favorites and print using favorite settings.

Registering a favorite

Follow the steps below to save the current print settings as a favorite.

1. Choose **Print** in the application menu.
2. Select the printer in the dialog box, and then display the printer driver dialog box. (→P.473)
3. Complete the print settings.
4. Click the **Favorites** tab to display the **Favorites** sheet.

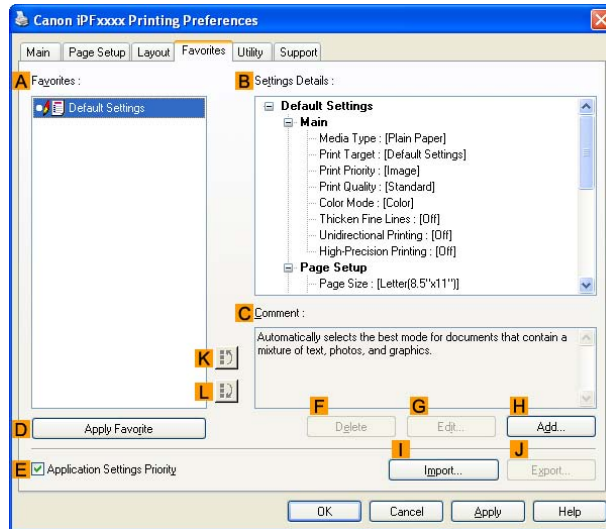

5. Click **H Add** to display the **Add** dialog box.
6. Complete the following settings in the **Add** dialog box.
 - Enter a desired name in **Name**, such as “Photos for Presentations” or “Monthly Report.”
 - Choose a fitting icon for these print settings in the **Icon** list.
 - In **Comment**, enter a description of the favorite to be added, as desired.
7. Click **OK** to close the **Add** dialog box.

The favorite you have added is now displayed in **A Favorites**.



Note

- To save a favorite as a file, click **J Export** and specify the file to save.

Printing using the favorite

Follow the steps below to print using the favorite you have registered.

1. Choose **Print** in the application menu.
2. Select the printer in the dialog box, and then display the printer driver dialog box. (→P.473)
3. Click the **Favorites** tab to display the **Favorites** sheet.

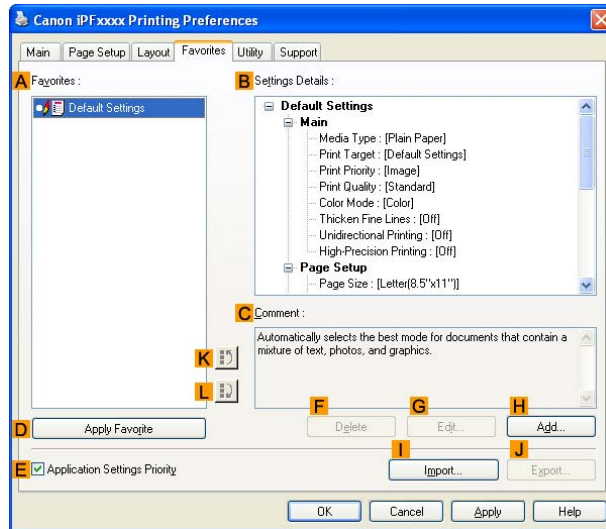

4. In the **A Favorites**, choose the favorite you registered.



Note

- To import a favorite, click **I Import** and specify the favorite file.

5. Click **D Apply Favorite** to replace the favorite settings with the current print settings.
6. Confirm the print settings and print as desired.



Note

- For instructions on confirming print settings, see “Confirming Print Settings (Windows)”. (→P.443)

Main Sheet (Windows)

The following settings are available on the **Main** sheet. For details on settings items, refer to the printer driver help.



Note

- On the **Main** sheet, choose **Easy Settings** to specify basic print settings based on the print target, or switch to **Advanced Settings** to complete more detailed settings as desired.

Configuration using Easy Settings

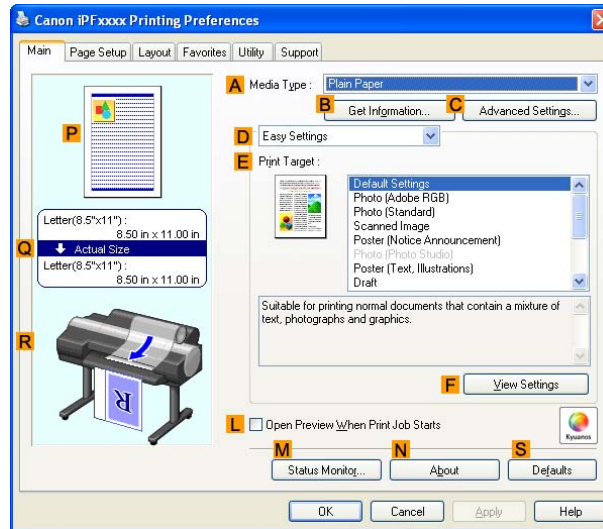

Setting Item	Description
A Media Type	Select the paper type. For information on the types of paper the printer supports, refer to the Paper Reference Guide . (→P.108)
B Get Information	Click to display the Get Information dialog box, which shows media types and sizes by media source, as specified on the printer. When you select a media source, your selection is applied to the printer driver settings for the media source, media type, and roll width.
C Preferences	Click to display the Media Detailed Settings dialog box for ink drying time and other detailed settings based on the paper type.
E Print Target	Choose presets that match the type of document to be printed. Printing Photos and Images (Windows, Mac OS X) (→P.177) Printing Line Drawings and Text (Windows, Mac OS X) (→P.181) Printing Office Documents (→P.183) Depending on the Media Type setting, some Print Target options may not be available.
F View Settings	Click to display the View Settings dialog box, which enables you to confirm the settings for the selected item from the E Print Target list or change the order of items listed in E Print Target .
L Open Preview When Print Job Starts	Activate this option to preview the print image before printing. Confirming the Print Image Before Printing (→P.485)

Setting Item	Description
M Status Monitor	Click to start imagePROGRAF Status Monitor , which enables you to confirm the status of the printer and print jobs. You can also set up email notification if printer errors occur by completing the Email Notice settings. For details, refer to the Status Monitor help.
N About	Click to confirm version information for the printer driver.
S Defaults	Click to restore all settings on the sheet to the default values.

Configuration using Advanced Settings

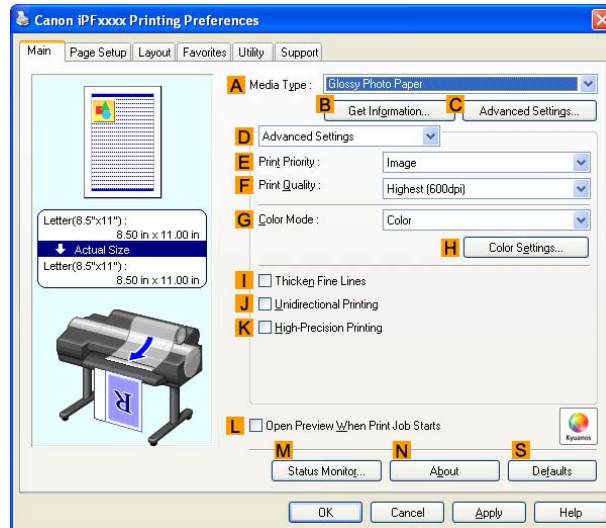

Setting Item		Description
A Media Type		Select the paper type. For information on the types of paper the printer supports, refer to the Paper Reference Guide . (→P.108)
	B Get Information	Click to display the Get Information dialog box, which shows media types and sizes by media source, as specified on the printer. When you select a media source, your selection is applied to the printer driver settings for the media source, media type, and roll width.
	C Preferences	Click to display the Media Detailed Settings dialog box for ink drying time and other detailed settings based on the paper type.
E Print Priority		Choose the graphic elements that you want to emphasize for printing. Giving Priority to Particular Graphic Elements and Colors for Printing (→P.173)
F Print Quality		Choose the level of print quality. Giving Priority to Particular Graphic Elements and Colors for Printing (→P.173)
G Color Mode		Choose the color mode. Giving Priority to Particular Graphic Elements and Colors for Printing (→P.173) The available Color Mode options vary depending on the Media Type setting.
	H Color Settings	Click to display the Color Settings dialog box for more advanced color settings. Adjusting the Color in the Printer Driver (→P.184)
I Thicken Fine Lines		Activate this option to print fine lines more distinctly.
J Unidirectional Printing		Although unidirectional printing is slower, it can help prevent misaligned lines and ensure better results.
K High-Precision Printing		Select this option for printing at the highest level of quality. However, this will take more time than regular printing.
L Open Preview When Print Job Starts		Activate this option to preview the print image before printing. Confirming the Print Image Before Printing (→P.485)

Setting Item	Description
M Status Monitor	Click to start imagePROGRAF Status Monitor , which enables you to confirm the status of the printer and print jobs. You can also set up email notification if printer errors occur by completing the Email Notice settings. For details, refer to the Status Monitor help.
N About	Click to confirm version information for the printer driver.
S Defaults	Click to restore all settings on the sheet to the default values.

Page Setup Sheet (Windows)

The following settings are available on the **Page Setup** sheet. For details on settings items, refer to the printer driver help.

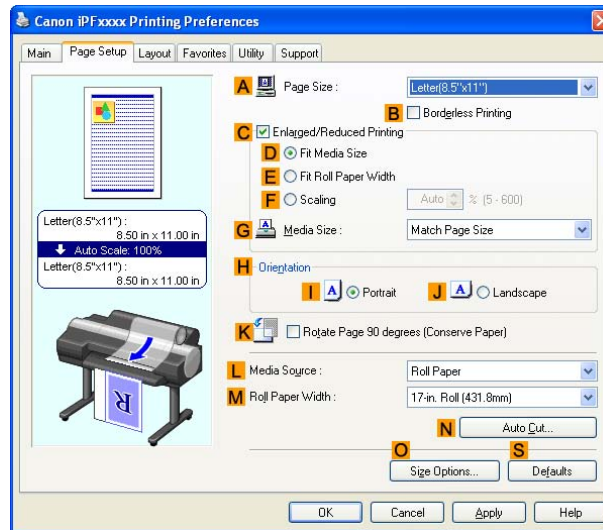

Setting Item	Description
A Page Size	Select the page size as specified in the source application. For details on available page sizes, see "Paper Sizes". (→P.113)
B Borderless Printing	Borderless printing is available if Roll Paper is selected in the L Media Source list. Choose from the following options when this setting is activated. Borderless Printing on Paper of Equivalent Size (→P.297) Borderless Printing by Resizing Originals to Fit the Roll Width (→P.299) Borderless Printing at Actual Size (→P.279)
D Fit Media Size	Scales the document image to match the paper size.
E Scale to fit Roll Paper Width	Scales the document image to match the roll width.
F Print Image with Actual Size	Prints documents at their actual size. This function is available, when you have selected the size same as the width of Roll Paper for either length or width of the document from the A Page Size list.
G Media Size Available when Fit Media Size is selected.	Choose the size of the paper you will print on. For details on available paper sizes, see "Paper Sizes". (→P.113) Paper sizes compatible with borderless printing are shown in the list.
C Enlarged/Reduced Printing	Choose from the following options when this setting is activated. Resizing Originals to Match the Paper Size (→P.244) Resizing Originals to Fit the Roll Width (→P.245) Resizing Originals by Entering a Scaling Value (→P.246)
D Fit Media Size	Scales the document image to match the paper size.
E Fit Roll Paper Width	Scales the document image to match the roll width.
F Scaling	Resizes the document image based on a specified scaling value. Enter a value in a range of "5-600."
G Media Size	Choose the size of the paper you will print on. For details on available paper sizes, see "Paper Sizes". (→P.113)

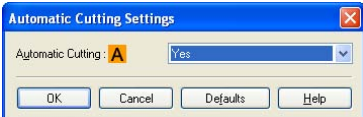
Setting Item	Description
H Orientation	Choose the printing orientation. Making the Original Orientation Match the Paper Orientation (→P.420)
K Rotate Page 90 degrees (Conserve Paper)	Activate this setting to rotate the document image by 90 degrees before printing. Conserving Roll Paper by Rotating Originals 90 Degrees (→P.395)
L Media Source	Choose how paper is supplied. Options displayed in the list vary depending on the selection in Media Type in the Main sheet.
M Roll Paper Width	Choose the roll width. For details on available roll widths, see “Paper Sizes”. (→P.113)
N Auto Cut	<p>You can activate or deactivate automatic cutting and printing of cut lines, as desired. Click to display the Automatic Cutting Settings dialog box.</p>  <p>Under Automatic Cutting, you can specify Yes or No and Print Cut Guideline.</p> <p>Cutting Roll Paper After Printing (→P.421)</p>
O Size Options	Click to display the Media Size Options dialog box, which enables you to register additional paper sizes or select the size system for use.
S Defaults	Restores all settings on the sheet to the default values.

Layout Sheet (Windows)

The following settings are available on the **Layoutsheet**. For details on settings items, refer to the printer driver help.

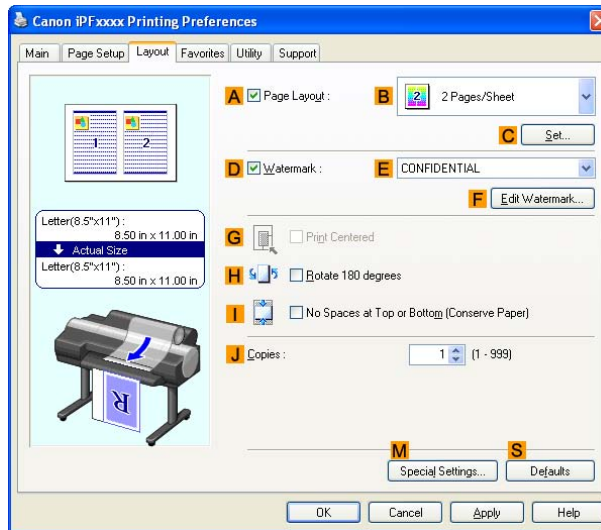

Setting Item	Description
A Page Layout	Activate this setting to select a particular page layout. Printing Multiple Pages Per Sheet (→P.355) Printing Posters in Sections (→P.356) Printing Multiple Originals Next to Each Other (→P.352) Using PosterArtist to Compose Originals (→P.423)
C Set	Click to display one of the following dialog boxes depending on the selection in A Page Layout . In these dialog boxes, you can specify layout details and which pages to print, as well as other settings. <ul style="list-style-type: none"> • Page Layout Printing • Pages to Print • Free Layout Settings
D Watermark	Activating this option makes two settings available, E Watermarks and F Edit Watermark . Printing With Watermarks (→P.419)
E Watermarks	Lists the provided watermarks. Choose the watermark to print.
F Edit Watermark	Click to display the Edit Watermark dialog box for creating your own, original watermark.
G Print Centered	Activate this setting to print document images in the center of the paper. Printing Originals Centered on Rolls (→P.378) Printing Originals Centered on Sheets (→P.379)
H Rotate 180 degrees	Activate this option to rotate document images by 180 degrees before printing.
I No Spaces at Top or Bottom (Conserve Paper)	Activate this setting to print the next image skipping blank areas above and below printable data in documents, which enables you to conserve the paper. Conserving Roll Paper by Printing Originals Without Top and Bottom Margins (→P.396)
J Copies	Enter the number of copies to print, in a range of "1-999."
Reverse Order	Activate this option to print pages in reverse order.
Collate	Activate this option to print complete sets in the specified quantity.

Setting Item	Description
M Special Settings	If the printing results are not as you expected, click this option to change how printing is processed.
S Defaults	Click to restore all settings on the sheet to the default values.

Gray Adjustment Sheet (Windows)

The following settings are available on the **Gray Adjustment** sheet.

Gray Adjustment

On the **Gray Adjustment** sheet, you can adjust the color balance, brightness, contrast, and other image qualities.

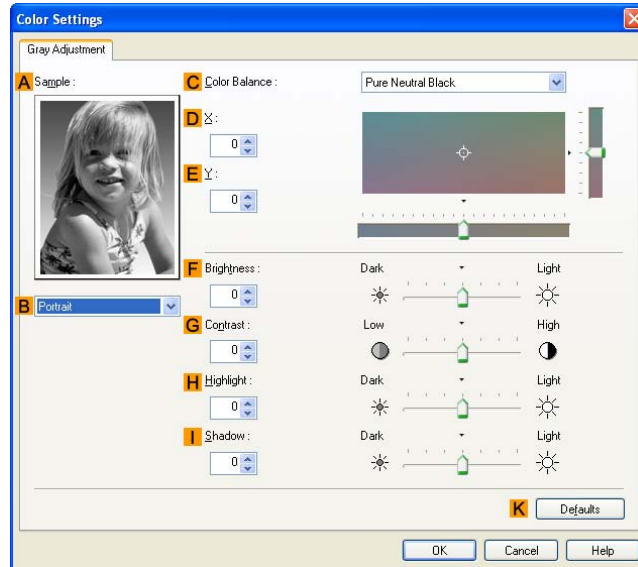

Note

- To display the **Gray Adjustment** sheet, on the **Main Sheet (Windows)** (→P.450), select **Monochrome (Photo)** by **Color Mode** in **Advanced Settings**, and then click **Color Settings**.
- Monochrome (Photo)** is not available for all types of paper.

Setting Item	Description
A Sample	The image at left is updated to reflect any changes you make to setting items on the sheet, enabling you to check the results of adjustment.
B Sample List	Select a sample image, as desired.
C Color Balance	Click the list to select a color balance that suits the printing application.
D X	Adjust the color balance as you check the color tone in the adjustment area. You can adjust the square area in the center by clicking or dragging it. Drag the vertical or horizontal scroll bars for adjustment, as desired. You can click the arrows by the X (horizontal) and Y (vertical) boxes or enter the values directly.
E Y	
F Brightness	Adjust the overall image brightness as desired. You can adjust the brightness if the printed document is lighter or darker than the original image (that is, the original photo that was scanned or the original graphic as it appears on the computer screen).
G Contrast	Adjust the contrast of the darkest and lightest portions relative to each other, as desired. Increasing the Contrast makes images sharper, and reducing the Contrast softens images.
H Highlight	Adjust the brightness of the lightest portion.
I Shadow	Adjust the brightness of the darkest portion.
K Defaults	Click to restore all settings on the sheet to the default values.

Favorites Sheet (Windows)

The following settings are available on the **Favorites** sheet. For details on settings items, refer to the printer driver help.

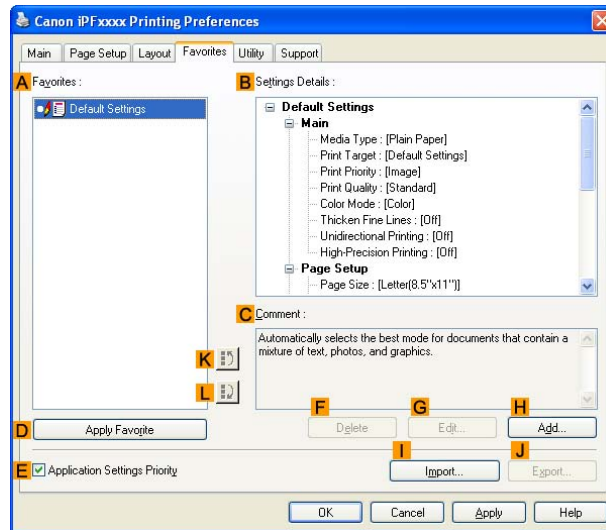

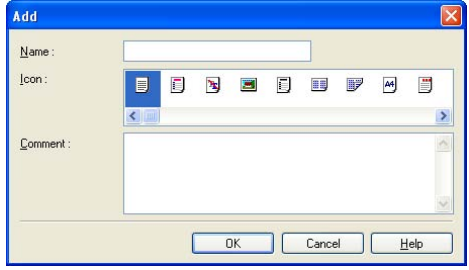
Setting Item	Description
A Favorites	Printing favorites you have created are listed with Default Settings favorites. Using Favorites (→P.421)
B Settings Details	Displays details of the favorite selected in the A Favorites .
C Comment	Displays notes registered in the favorite.
D Apply Favorite	Click to change the current print settings to those of the favorite selected in the A Favorites .
E Application Settings Priority	Activate this setting to use settings values specified in the source application in preference to favorite settings selected in the A Favorites , when clicking D Apply Favorite . For details on the settings items used in preference, refer to the printer driver help.
F Delete	Click to delete the selected favorite settings from the A Favorites .
G Edit	Click to display the Edit dialog box, which enables you to change the name and icon for the favorite settings selected in the Favorites .
H Add	Click to display the Add dialog box, which enables you to add the current print settings as a favorite. 
I Import	Click to display the Open dialog box, which enables you to import favorite settings saved as a file.
J Export	Click to display the Save As dialog box, which enables you to save the favorite settings as a file.

Utility Sheet (Windows)

The following settings are available on the **Utility** sheet. For details on the utilities, refer to the relevant utility help.

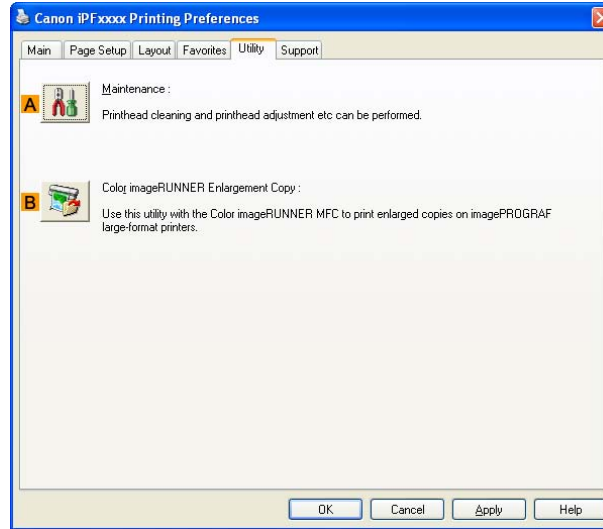

Button	Corresponding Utility
A Maintenance	Click to start the imagePROGRAF Status Monitor , which offers the following maintenance for the printer. <ul style="list-style-type: none"> • Nozzle (ink ejecting outlet) check • Nozzle (ink ejecting outlet) cleaning • Head alignment adjustment • Feed amount adjustment
B Color imageRUNNER Enlargement Copy	Click to launch Color imageRUNNER Enlargement Copy (*1) (iR enlargement copy), which enables you to create hot folders used for Color imageRUNNER Enlargement Copy and assign print settings to hot folders. Printing Enlargements of Scanned Originals from a Color imageRUNNER (Windows) (→P.248)

*1: For details, see Color imageRUNNER Enlargement Copy Guide .

Support Sheet (Windows)

On the **Support** sheet, you can view support information and the user's manual.

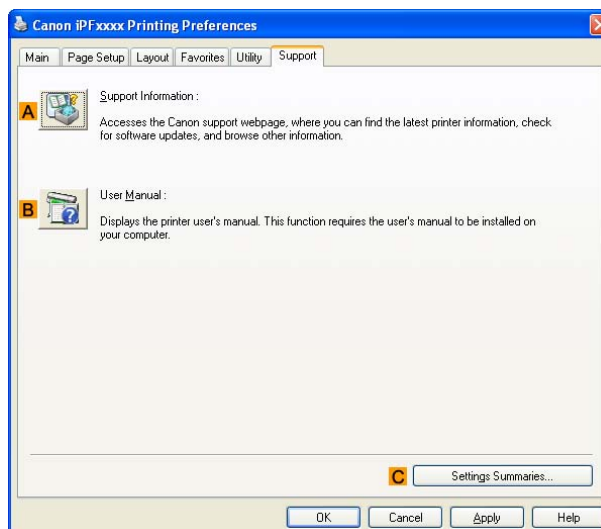

Button	Corresponding Utility
A Support Information	Click to access the Canon support webpage, where you can find the latest information on the printer and consumables, check for printer driver updates, and browse other information.
B User Manual	Click to view the printer user's manual. This function requires the user's manual to be installed on your computer.
C Settings Summaries	Click to display the View Settings dialog box, which enables you to confirm the settings for the Main , Page Setup , Layout , and Favorites sheets.

☐ Device Settings Sheet (Windows)

Many settings items on the printer properties sheets are controlled by Windows applications. However, the **Device Settings** sheet is for configuring the printer, and it is an extension of the printer driver. The following settings are available on the **Device Settings** sheet.

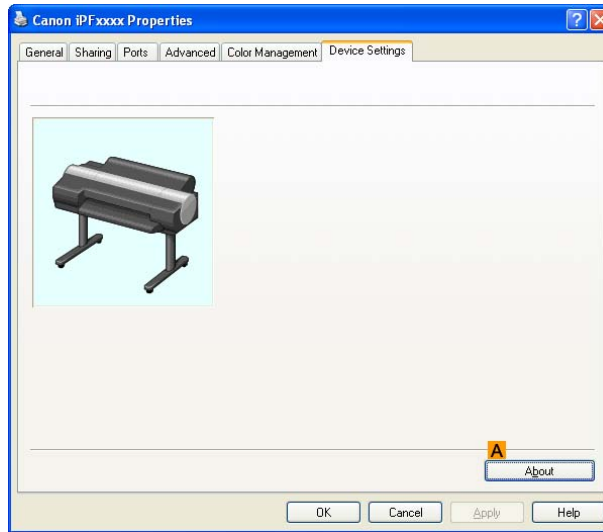

Setting Item	Description
A About	You can display version information for the printer driver.

Using PosterArtist to Compose Originals (Windows)

This topic describes how to use PosterArtist to compose originals from multiple applications, creating a poster layout for printing.



Important

- PosterArtist (sold separately) must be installed to use this function.

1. Choose **Print** in the application menu.
2. Select the printer in the dialog box, and then open the printer driver dialog box. (→P.473)
3. Make sure the **Main** sheet is displayed.

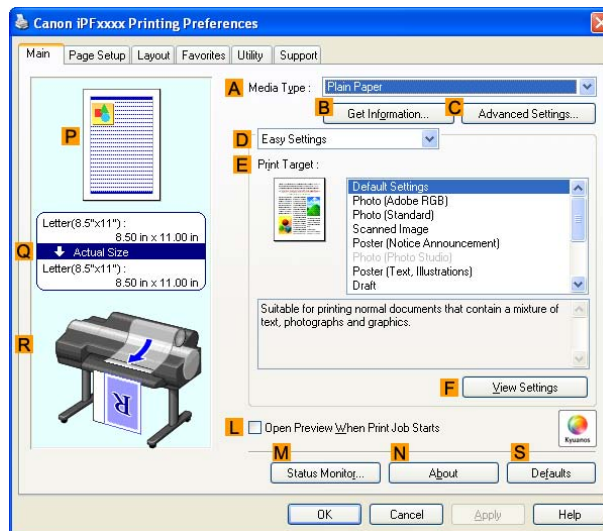

4. Click the **Layout** tab to display the **Layout** sheet.

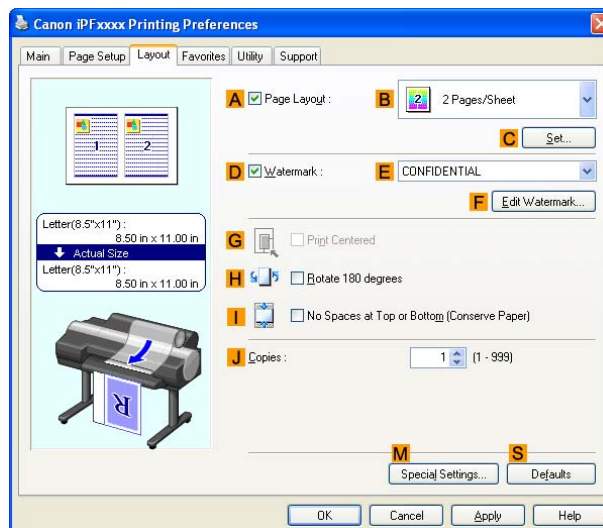

5. Select the **A Page Layout** check box.
6. Click in the **Edit Using PosterArtist** in the **B Page Layout** list.
7. When you attempt to print, PosterArtist starts up and the PageCapture window is displayed. (At this point, the document will not be printed yet.)
8. Choose the page to load in PosterArtist.

9. Edit and rearrange the image in the PosterArtist window as desired.



Important

- Without closing the PosterArtist window, repeat steps 1-8 to arrange originals from multiple applications on the same page.



Note

- For instructions on editing and rearranging images, refer to the PosterArtist Manual.

10. Print from the PosterArtist menu.

Printing Adobe RGB Images (Windows)

This topic describes how to print Adobe RGB images based on the following example.

- Document: Adobe RGB image created in Photoshop
- Page Size: 10×12 inches (254.0×304.8 mm)
- Paper: Roll
- Paper type: Glossy Photo Paper
- Roll Paper Width: 10 inches (254.0 mm)



Important

- In Photoshop, select no color-matching.
- In the printer driver settings, select **Driver Matching Mode** and choose **Adobe RGB** in **Color Space**.

1. In Photoshop, create an image in the Adobe RGB color space.



Note

- The following procedures are based on the example of Photoshop CS2.
- For instructions on creating Adobe RGB images, refer to the Photoshop documentation.

2. Choose **Print with Preview** from the **File** menu to display the **Print** dialog box.

3. Make sure the setting mode is **Color Management**.

4. In the **Color Handling** list in **Options**, click **No Color Management**.

5. Click **Print** to display the **Print** dialog box.

6. Select the printer and click **Properties** to display the printer driver dialog box.

7. Make sure the **Main** sheet is displayed.

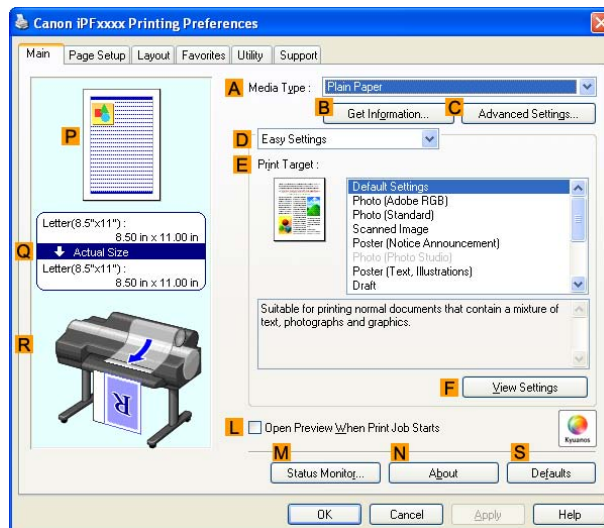

8. In the **A Media Type** list, select the type of paper that is loaded. In this case, click **Glossy Photo Paper**.

9. Click **D Advanced Settings** to switch the print mode.

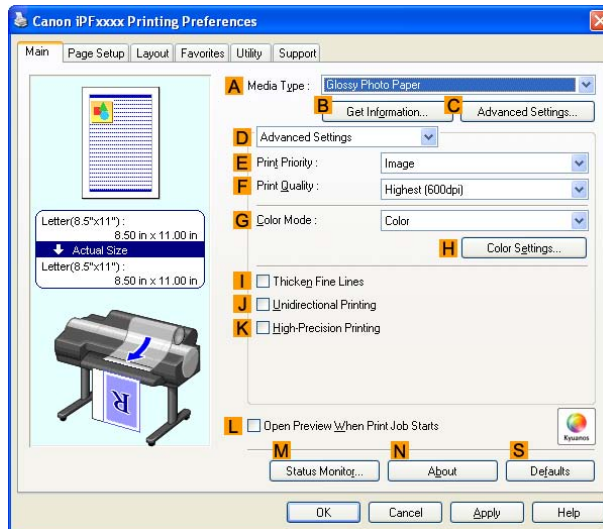

10. Click **Image** in the **E Print Priority** list.

11. Select the print quality in the **F Print Quality** list.



Note

- Options displayed in the **F Print Quality** list vary depending on the paper type.

12. Click **Color** in the **G Color Mode** list.

13. Click **H Color Settings** to display the **Color Settings** dialog box.

14. Click the **Matching** tab to display the **Matching** sheet.

15. In **Matching Mode**, click **Driver Matching Mode**.

16. In **Color Space**, click **Adobe RGB**.

17. Click **OK** to close the **Color Settings** dialog box.

18. Click the **Page Setup** tab to display the **Page Setup** sheet.

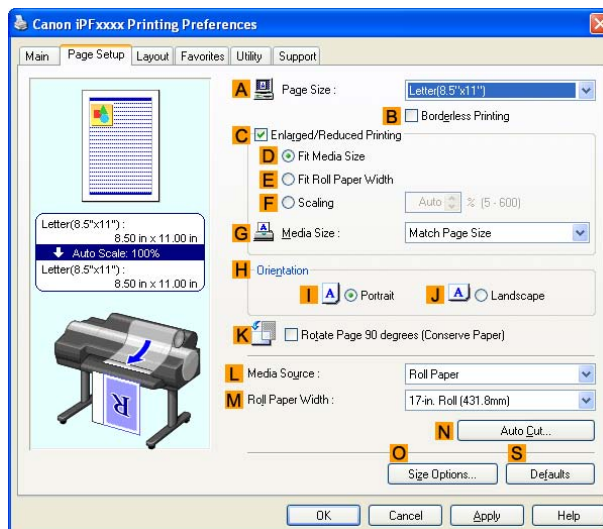

- 19.** In the **A Page Size** list, click the size of the original as specified in the source application.
In this case, click **10"x12"**.
- 20.** Click **Roll Paper** in the **L Media Source** list.
- 21.** Select the width of the loaded roll in the **Roll Paper Width** list. In this case, click **10-in. Roll (254.0mm)**, and then click **OK**.
- 22.** Confirm the print settings and print as desired.

**Note**

- For tips on confirming print settings, see “Confirming Print Settings (Windows)”. (→P.443)

imagePROGRAF Status Monitor (Windows)

imagePROGRAF Status Monitor is a utility for checking the printer status and managing print jobs. Two screens are available in imagePROGRAF Status Monitor : “Printer List” shows a list of printers, and “Status Monitor” shows details for each printer.

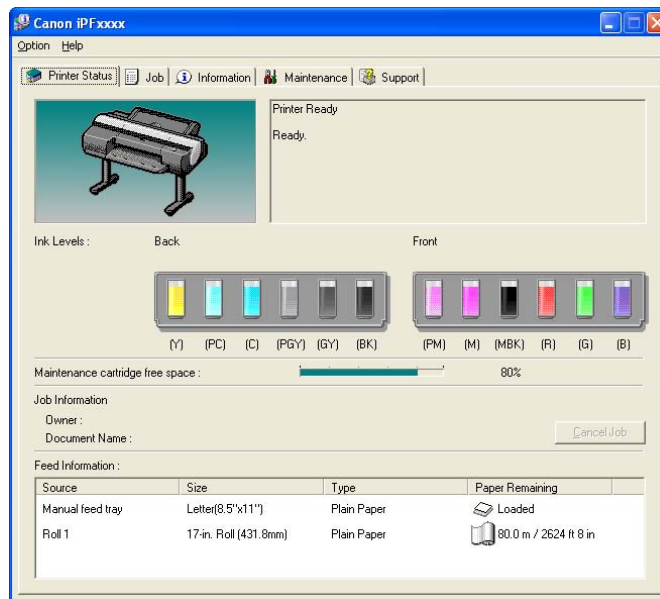
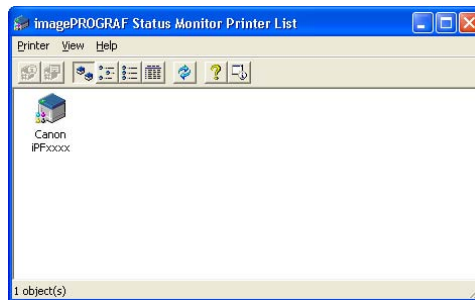

- You can view a list of the printers for which printer drivers have been installed on your computer, printers connected to your computer, and printers found on the network.
- Printer status can be checked in real time on a computer monitor.
- If a printer error occurs, you can investigate the corrective action immediately.
- Images of Ink Tanks are shown, with different images for various types of ink. An icon and warning message will notify you when ink levels are low.
- The type of paper loaded in each media source is identified. You can also check to see if paper has run out.
- This way, the utility enables you to check printer information and take care of printer maintenance for optimal printing results.
- You can also set up automatic email notification of any printer problems or errors to email addresses you designate in advance.



Note

- For details, refer to the imagePROGRAF Status Monitor help.

imagePROGRAF Device Setup Utility

imagePROGRAF Device Setup Utility is a utility to establish communication between the printer and your computer by completing relevant settings. After the printer is installed, for example, you can use imagePROGRAF Device Setup Utility to complete the network settings initially.

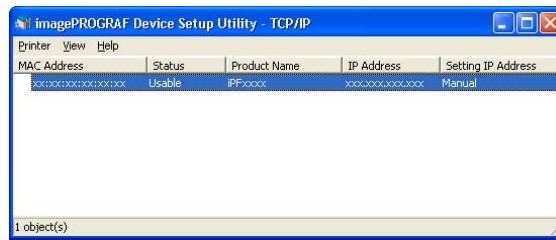

- Starting imagePROGRAF Device Setup Utility will show a list of printers found on the network. In this list, select the printer (specifically, the printer's MAC address) that you want to set up, and then configure the basic settings from your computer, such as the printer's IP address and the network frame type.
- You can see which printers are online in the network by checking the printer list. Communication between your computer and these printers is possible.



Note

- We recommend that your network or printer administrator complete the setup work using imagePROGRAF Device Setup Utility.
- For details, refer to the imagePROGRAF Device Setup Utility help.

Installing imagePROGRAF Device Setup Utility

Install imagePROGRAF Device Setup Utility from the User Software CD-ROM provided with the printer as follows:



Important

- In Windows 2000/Windows XP/Windows Server 2003/Windows Vista, you must log on with administrative rights equivalent to the “Administrator” account.

1. Insert the User Software CD-ROM in the CD-ROM drive.
2. On the **Setup Menu** window, click **Install Individual Software**.
3. Click **Install** in imagePROGRAF Device Setup Utility.
4. Follow the instructions on the screen to proceed with the installation.

Configuring the IP Address Using imagePROGRAF Device Setup Utility

From a computer running Windows, you can use imagePROGRAF Device Setup Utility provided with the printer to configure the printer's IP address. This topic describes how to configure the IP address using imagePROGRAF Device Setup Utility.



Important

- To configure network settings, you must be logged in with administrative rights such as “Administrator” account. We recommend that your network administrator configure the network settings.
- For instructions on installing imagePROGRAF Device Setup Utility, see “Installing imagePROGRAF Device Setup Utility”. (→P.470)

1. Start imagePROGRAF Device Setup Utility from the **start** menu.
2. In the list of printers, select the printer to configure.
3. Choose **Protocol Settings** from the **Printer** menu.
4. In the **Setting IP Address** list, choose **Manual**.
5. Enter the IP address assigned to the printer and click the **Set** button.
6. Click **OK** after the **Confirmation** message dialog box is displayed.
7. Exit imagePROGRAF Device Setup Utility.



Note

- To configure the IP address automatically, choose **Auto** in the **Setting IP Address** list and select **DHCP**, **BOOTP**, or **RARP**.
- You can also specify the subnet mask and default gateway.

☐ Digital Photo Front-Access

Digital Photo Front-Access is an application that links photos from Canon digital cameras and other image files on your computer with various other applications.

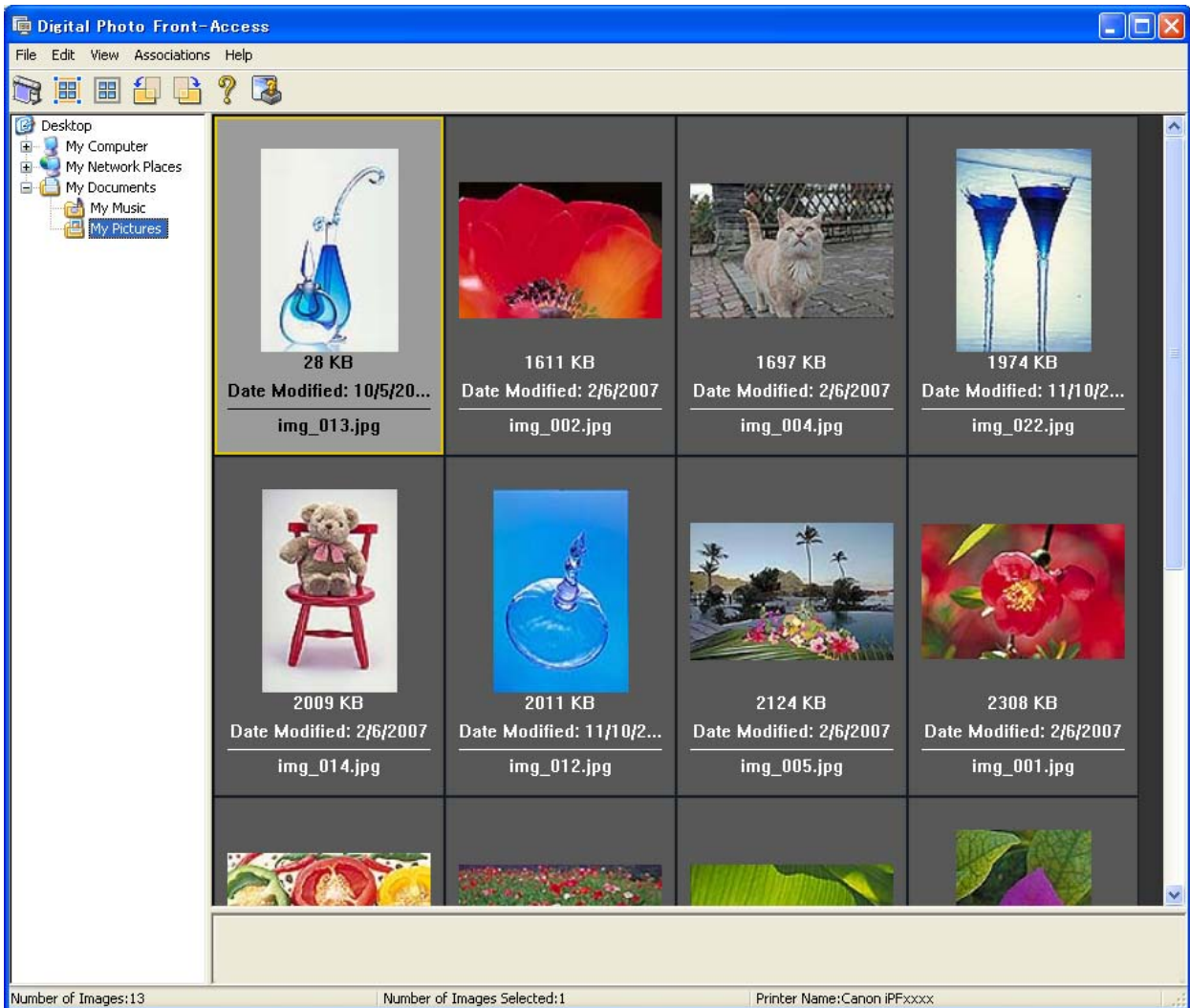

- Simply select an image and click the icon of the application you want to start to launch the application.
- You can also print from Digital Photo Front-Access. In short, Digital Photo Front-Access can help you manage images in many ways from editing to printing as an effective way to work with other applications.
- Digital Photo Front-Access also enables image retouching. For automatic retouching, select an image for retouching and click Image Adjustment.
- Because this application automates the workflow from retouching to display for all of your images, it can save time and work in retouching.



Note

- For details, refer to the Digital Photo Front-Access help.

Accessing the Printer Driver Dialog Box from Applications (Windows)

1. Choose **Print** from the **File** menu to display the dialog box for printing conditions.
2. Select the printer, and then display the printer driver dialog box.



Note

- The dialog box for specifying printing conditions varies depending on the source application. In some cases, when you select the printer, a sheet for configuring the printer driver is added to the dialog box. In the following case, click **Preferences**.

- Example: Print dialog box displayed by the application software

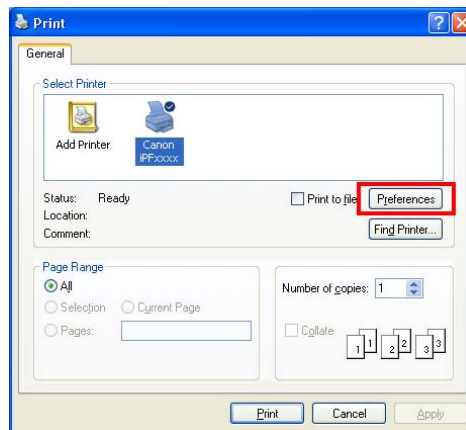

Six sheets of print settings are displayed by the printer driver: **Main**, **Page Setup**, **Layout**, **Favorites**, **Utility**, and **Support**.

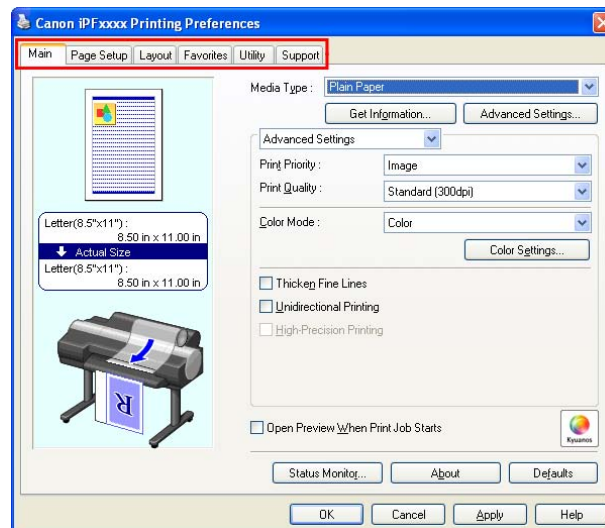

Note

- The titles of dialog boxes may vary depending on the application, and sheets other than these six sheets may be displayed.



Important

- If you access the printer driver dialog box from the source application, changes you make to the settings will only apply temporarily to that application. Because these are sizes you specify temporarily in the printer driver, the sizes will not be available after you exit the application.
- You can also access the printer driver dialog box from the Windows system menu. see “Accessing the Printer Driver Dialog Box from the Operating System Menu (Windows)”. (→P.149)

Accessing the Printer Driver Dialog Box from the Operating System Menu (Windows)

1. Click **start > Printers and Faxes** (or **Printers**).
2. Select the printer, and then display the printer properties dialog box.

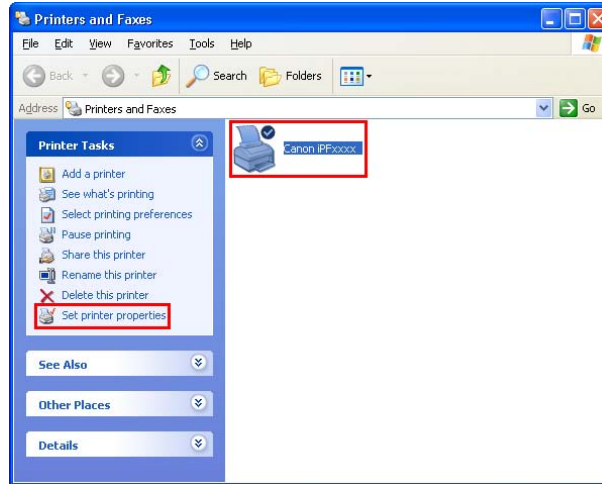

3. Click **Printing Preferences** to display the **Printing Preferences** dialog box, titled with the name of this printer.

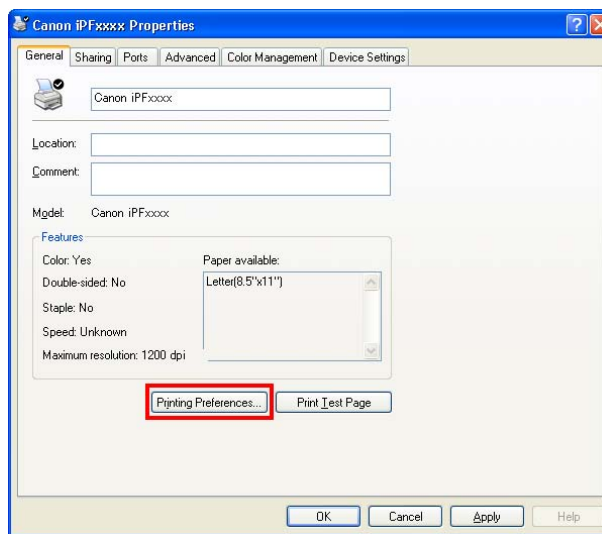

Note

- The **Device Settings** sheet is also an extension of the printer driver. (→P.462)

Six sheets of print settings are displayed by the printer driver: **Main**, **Page Setup**, **Layout**, **Favorites**, **Utility**, and **Support**.

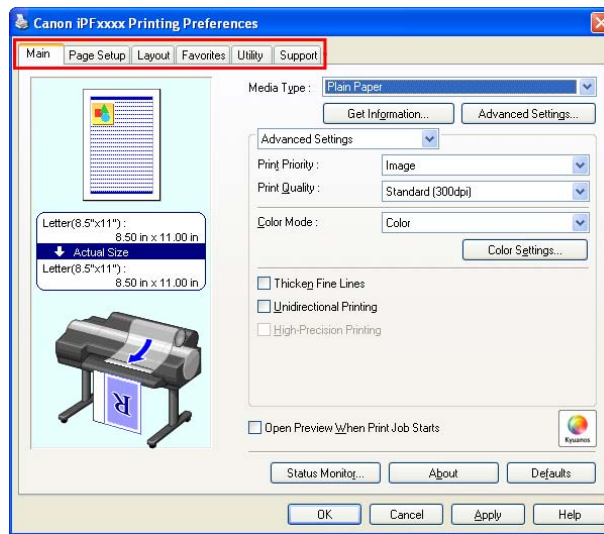

Important

- If you access the printer driver dialog box from the operating system menu, changes you make to the settings will apply to all applications you use for printing.
- You can also access the printer driver dialog box from applications.
see “Accessing the Printer Driver Dialog Box from Applications (Windows)”. (→P.473)

Color Settings Sheet: Color (Windows)

In general, make any needed adjustments to the color of documents in the application used to create them. However, if the color tone as printed is not as you expected, you can also adjust the color in the printer driver.

Color Adjustment : color

If the color tone as printed is not as you expected, you can adjust it on the **Color Adjustment** sheet.

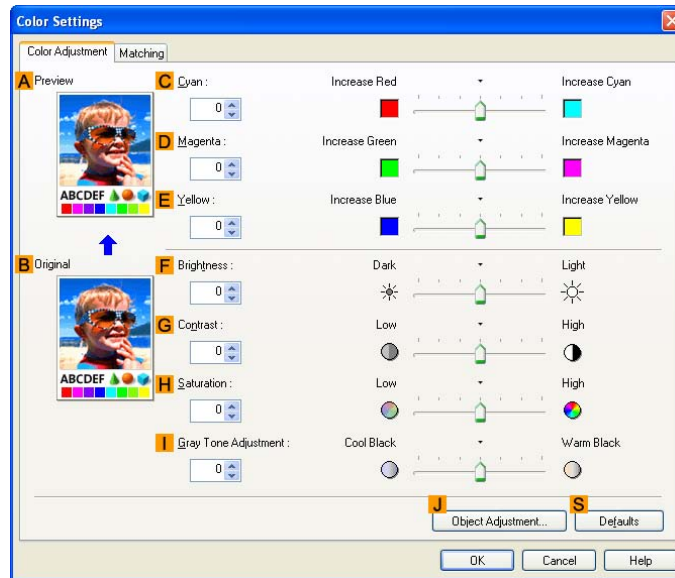

Note

- To display the **Color Adjustment** sheet, on the **Main Sheet (Windows)** (→P.450), click **Color Settings** by **Color Mode** in **Advanced Settings**.

Setting Item	Description
A Preview	The image at left is updated to reflect any changes you make to setting items on the sheet, enabling you to check the results of adjustment.
B Original	The image at right shows the original state before adjustment. You can compare it to the Preview image.
C Cyan	Correct color tones by adjusting the levels of each color.
D Magenta	
E Yellow	
F Brightness	Adjust the overall image brightness as desired. You can adjust the brightness if the printed document is lighter or darker than the original image (that is, the original photo that was scanned or the original graphic as it appears on the computer screen).
G Contrast	Adjust the contrast of the darkest and lightest portions relative to each other, as desired. Increasing the Contrast makes images sharper, and reducing the Contrast softens images.
H Saturation	Adjust the color intensity as desired. Increasing the Saturation setting makes colors more vivid, and reducing the Saturation makes colors more subdued.
I Gray Tone Adjustment	Adjust the color tone of grays as desired. Choose Cool Black (tinged with blue), Warm Black (tinged with red), and so on.

Setting Item	Description
J Object Adjustment	Select this option to display the Object Adjustment dialog box, in which you can specify objects subject to color adjustment.
S Defaults	Click to restore all settings on the sheet to the default values.



Note

- For details on settings items, see “Adjusting the Color in the Printer Driver”. (→P.184)

Object Adjustment dialog box

In the **Object Adjustment** dialog box, you can specify what type of print jobs to apply color adjustment to. If an original comprises images, graphics, and text, you can specify which portion to apply color adjustment to.

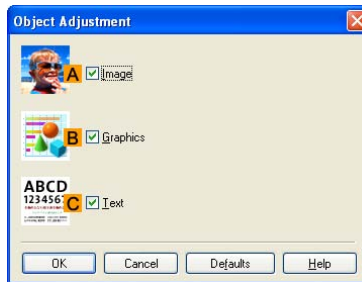

Note

- To display the **Object Adjustment** dialog box, click **Object Adjustment** on the **Color Adjustment** sheet.

Setting Item	Description
A Image	Select this option to apply color adjustment to image areas, such as photos.
B Graphics	Select this option to apply color adjustment to graphics, such as lines and circles.
C Text	Select this option to apply color adjustment to text.

Matching sheet: Driver Matching Mode

On the **Matching** sheet, you can specify color matching, to compensate for differences in the appearance of colors on various devices. The following options are available when you select **Driver Matching Mode** in the **Matching Mode** list.

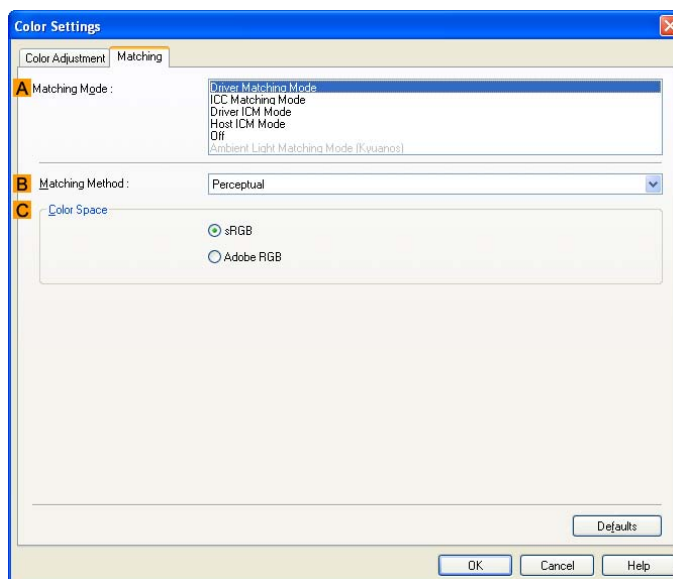

Note

- To display the **Matching** sheet, on the **Main Sheet (Windows)** (→P.450), click **Color Settings by Color Mode** in **Advanced Settings**, and then click the **Matching** sheet.

Setting Item	Description
A Matching Mode	Select the color matching mode to use, as desired. Normally, select Driver Matching Mode . For color matching based on ICC profiles, select ICC Matching Mode , Driver ICM Mode , or Host ICM Mode , depending on your color matching system. If you don't want color matching using the printer driver, select Off .
B Matching Method	Select the color matching method that suits the document to be printed. Various Matching Method options are available depending on your selection in Matching .
C Color Space	Select the applicable color space as desired.



Note

- For details on settings items, see "Adjusting the Color in the Printer Driver". (→P.184)

Matching sheet: ICC Matching Mode, Driver ICM Mode, and Host ICM Mode

On the **Matching** sheet, you can specify color matching, to compensate for differences in the appearance of colors on various devices. The following options are available when you select **ICC Matching Mode**, **Driver ICM Mode**, or **Host ICM Mode** on the **Matching Mode** sheet.

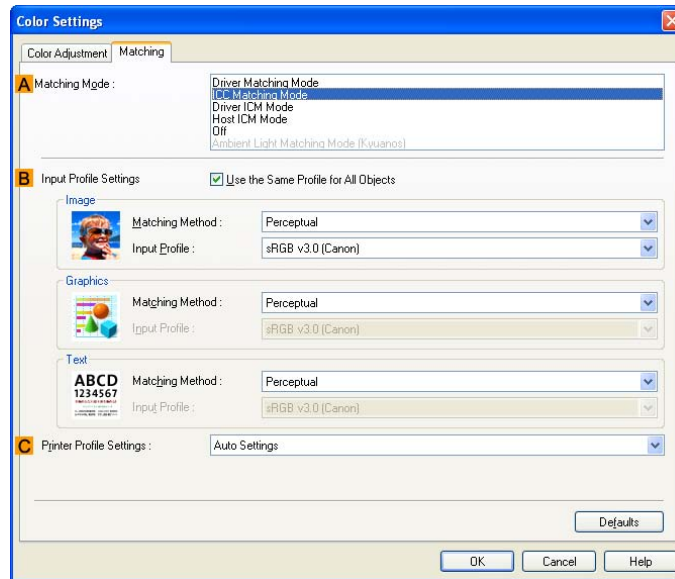

Note

- To display the **Matching** sheet, on the **Main Sheet (Windows)** (→P.450), click **Color Settings** by **Color Mode** in **Advanced Settings**, and then click the **Matching** sheet.

Setting Item	Description
A Matching Mode	Select the color matching mode to use, as desired.
B Input Profile Settings	You can select Image , Graphics , or Text . You can choose Matching Method and Input Profile . Various options are available depending on your selected Matching Mode . To apply the same input profile automatically for Graphics and Text , select Use the Same Profile for All Objects . To apply separate input profiles to Graphics and Text , clear Use the Same Profile for All Objects and specify the individual settings.
C Printer Profile Settings	Specify the printer profile as desired. Normally, select Auto Settings .



Note

- For details on settings items, see “Adjusting the Color in the Printer Driver”. (→P.184)

Matching sheet: Ambient Light Matching Mode (Kyuanos)

On the **Matching** sheet, you can specify color matching to compensate for differences in the appearance of colors on various devices. The following options are available when you select **Ambient Light Matching Mode (Kyuanos)** in the **Matching Mode** list.

When you select **By selecting a chart number** in **Setting Method**

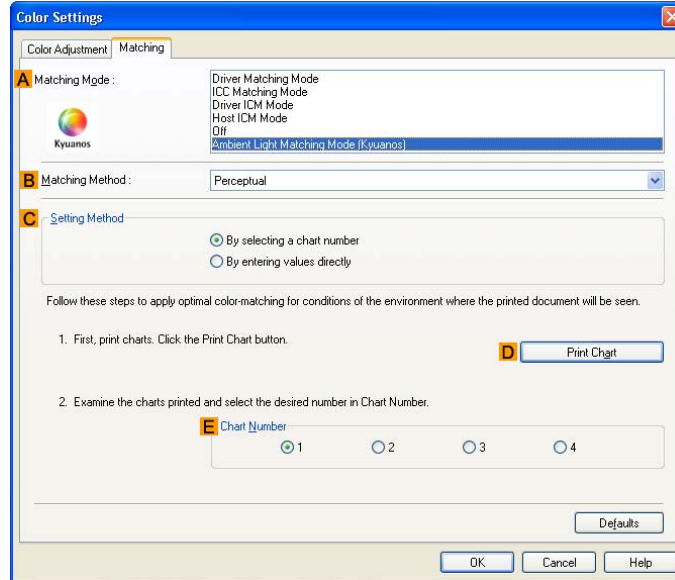

When you select **By entering values directly** in **Setting Method**

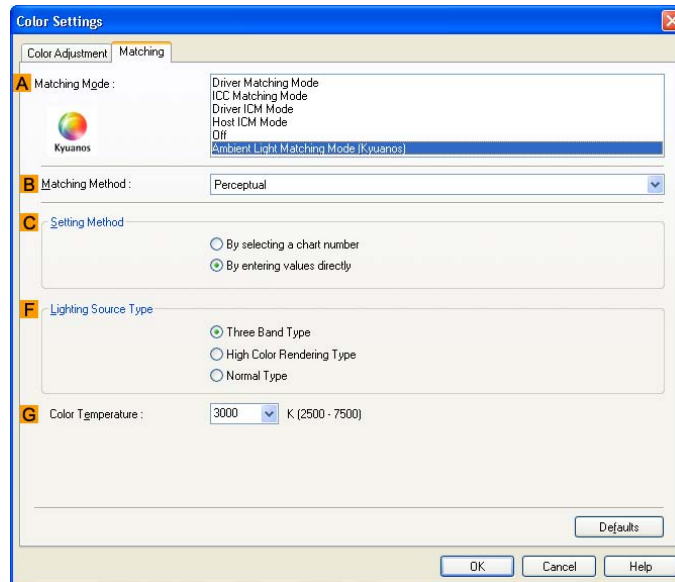

Setting Item	Description
A Matching Mode	Select the color matching mode to use, as desired. Here, select Ambient Light Matching Mode (Kyuanos) .
B Matching Method	Select the matching method.
C Setting Method	You can choose configuration based on printed Charts or based on using the Eye-One spectrophotometer.
D Print Chart	Click to start the Light Source Check Tool , for printing Charts . The Light Source Check Tool must be installed to use this function.

Setting Item	Description
E Chart Number	In Chart , select the number of the pattern with your desired colors.
F Lighting Source Type	Select the light source measured using the Eye-One spectrophotometer.
G Color Temperature	Select the value measured using the Eye-One spectrophotometer.

Light Source Check Tool

The **Light Source Check Tool** enables you to print **Chart**.

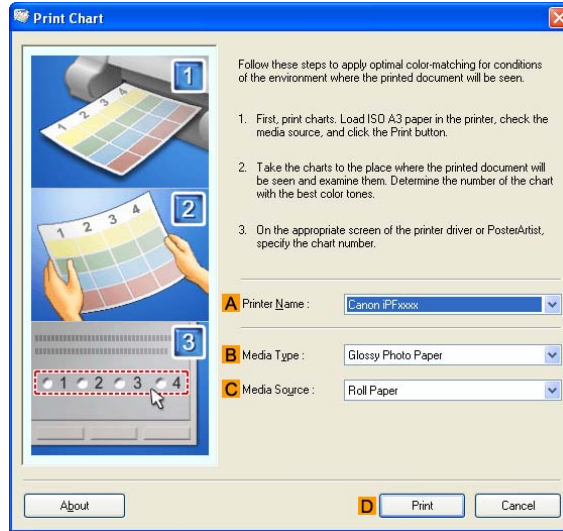

Setting Item	Description
A Printer	The printer name is displayed here.
B Media Type	Select the type of paper, as desired. For information on the types of paper compatible with Ambient Light Matching Mode (Kyanos) , refer to the Paper Reference Guide . (→P.108)
C Media Source	Choose the media source, as desired. Options displayed in the list vary depending on the selection in Media Type in the Main sheet.
D Print	Click to print the Chart .

Color Settings Sheet: Monochrome (Windows)

The following settings are available on the **Color Settings** sheet for monochrome printing.

Color Adjustment : monochrome

On the **Color Adjustment** sheet for monochrome printing, you can adjust the brightness and contrast.

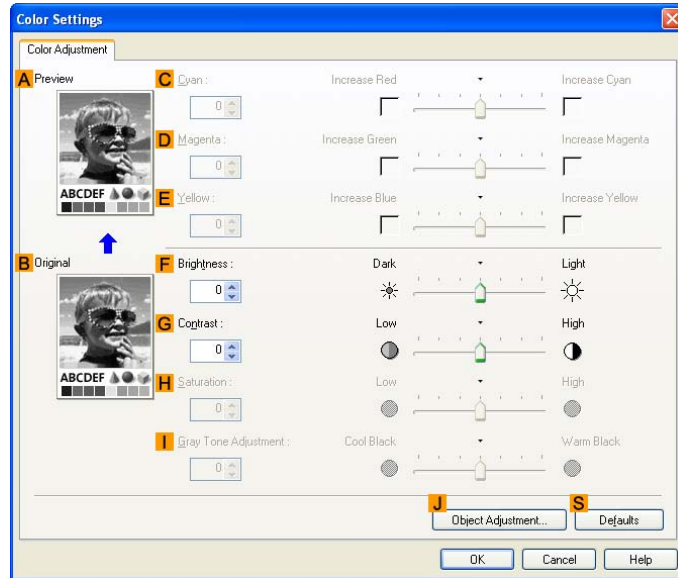

Note

- To display the **Color Adjustment** sheet, on the **Main Sheet (Windows)** (→P.450), click **Color Settings** by **Color Mode** in **Advanced Settings**.

Setting Item	Description
A Preview	The image at left is updated to reflect any changes you make to setting items on the sheet, enabling you to check the results of adjustment.
B Original	The image at right shows the original state before adjustment. You can compare it to the Preview image.
C Cyan	Not available.
D Magenta	
E Yellow	
F Brightness	Adjust the overall image brightness as desired. You can adjust the brightness if the printed document is lighter or darker than the original image (that is, the original photo that was scanned or the original graphic as it appears on the computer screen).
G Contrast	Adjust the contrast of the darkest and lightest portions relative to each other, as desired. Increasing the Contrast makes images sharper, and reducing the Contrast softens images.
H Saturation	Not available.
I Gray Tone Adjustment	Not available.
J Object Adjustment	Select this option to display the Object Adjustment dialog box, in which you can specify objects subject to color adjustment.
S Defaults	Click to restore all settings on the sheet to the default values.



Note

- For details on settings items, see “Adjusting the Color in the Printer Driver”. (→P.184)

Object Adjustment dialog box

In the **Object Adjustment** dialog box, you can specify what type of print jobs to apply color adjustment to. If an original comprises images, graphics, and text, you can specify which portion to apply color adjustment to.

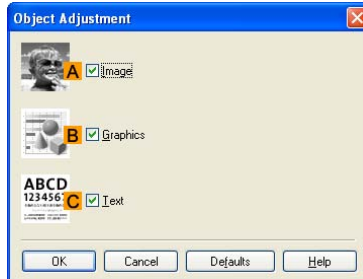

Note

- To display the **Object Adjustment** dialog box, click **Object Adjustment** on the **Color Adjustment** sheet.

Setting Item	Description
A Image	Select this option to apply color adjustment to image areas, such as photos.
B Graphics	Select this option to apply color adjustment to graphics, such as lines and circles.
C Text	Select this option to apply color adjustment to text.

Confirming the Print Image Before Printing

The preview screen displayed before printing enables you to see the original image just as it will be printed. Confirming the image of print jobs helps prevent printing errors.

For instructions on previewing print jobs, refer to the following topics, as appropriate for your computer and operating system.

- [Previewing Images Before Printing \(Windows\) \(→P.445\)](#)
- [Previewing Images Before Printing \(Mac OS X\) \(→P.497\)](#)
- [Previewing Images Before Printing \(Mac OS 9\) \(→P.520\)](#)

Media Detailed Settings Dialog Box (Windows)

The **Media Detailed Settings** dialog box offers the following settings. For details on settings items, refer to the printer driver help.

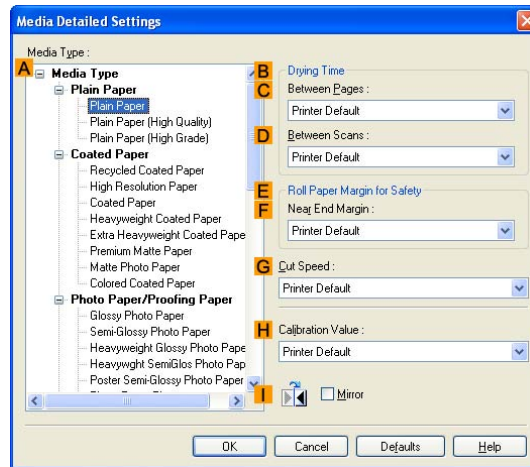

Note

- To display the **Media Detailed Settings** dialog box, on the **Main Sheet (Windows)** (→P.450), click **Settings by Media Type**.

Setting Item	Description
A Media Type	Select the paper type. For information on the types of paper the printer supports, refer to the Paper Reference Guide . (→P.108)
B Drying Time	Specify the time that the printer waits for ink to dry, as needed. The Drying Time setting is only valid for rolls. (→P.135)
C Between Pages	Specify the time the printer waits after printing a page until ejecting the paper, as needed.
D Between Scans	Specify the time the printer waits after printing a line on the page until printing the next line, as needed.
E Roll Paper Margin for Safety	You can specify the length of a margin on the leading edge of paper to ensure that paper susceptible to curling is held firmly against the Platen .
F Near End Margin	Specify the length of the Near End Margin (the leading edge margin) of the roll, as needed.
G Cut Speed	Select the speed of automatic cutting, as needed. You can adjust this setting if paper is not cut well when automatic cutting is used.
H Calibration Value	You can specify whether to apply the results of calibration performed on the printer to image processing.
I Mirror	Specify whether to print a mirror image, as needed. Select this option to print a version of the document or image with the left and right sides inverted.

Media Size Options Dialog Box (Windows)

In the **Media Size Options** dialog box, you can create and register your own **Custom Media Size**. The sizes you define are listed with standard media sizes for selection later as needed.

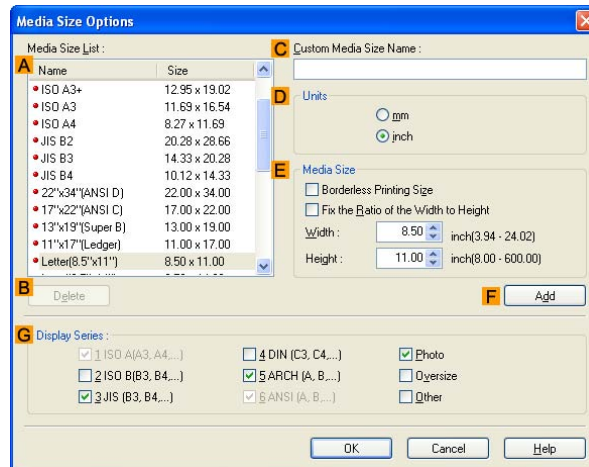

Note

- To display the **Media Size Options** dialog box, on the **Page Setup Sheet (Windows)** (→P.454), click **Media Size Options**.

Setting Item	Description
A Media Size List	Shows the names and sizes of paper that can be used with the printer driver.
B Delete	Custom media sizes created by users can be deleted from the Media Size List , as needed. However, they cannot be deleted in the following situations. <ul style="list-style-type: none"> If a standard media size of the printer driver is selected. If an oversized media size is selected. If a media size in a red box is selected.
C Custom Media Size Name	You can name Custom Media Size as desired.
D Units	Specify the desired unit of measure for the Custom Media Size height and width.
E Media Size	Specify the desired Width and Height . You can make your selection from sizes that are compatible with Borderless Printing by selecting Borderless Printing Size . To maintain the aspect ratio of the Width and Height as you resize the paper, select Fix the Ratio of the Width to Height .
F Add	Enables you to register the custom media size you have specified or overwrite an existing custom media size.
G Display Series	You can limit the number of options shown in Page Size , Media Size , and Media Size List .

Printing Enlargements of Scanned Originals from a Color imageRUNNER (Windows)

Scanned originals from a Color imageRUNNER can be enlarged and printed automatically.

Originals you create by scanning with a Color imageRUNNER are transferred to a "hot folder" and printed automatically after enlargement according to printing conditions you specify for that folder.

This processing sequence is called the Color imageRUNNER Enlargement Copy function.

To use Color imageRUNNER Enlargement Copy, first complete these settings in the following order.

1. Register a hot folder on your computer

Register a hot folder on your computer for storing scanned originals from the Color imageRUNNER and complete the settings for enlargement copy.

2. Complete the scanning settings on the Color imageRUNNER.

Configure the Color imageRUNNER to send scanned originals to the hot folder.

After these settings are complete, you can print enlarged copies of scanned originals from the Color imageRUNNER.

Registering a hot folder on your computer

Folders used for **Color imageRUNNER Enlargement Copy** (iR enlargement copy) are called hot folders.

Register a hot folder on your computer for storing scanned originals from the Color imageRUNNER. You can specify printing conditions (such as the image quality and paper size), based on which originals transferred to the hot folder will be printed. Follow these steps to register and modify hot folders.

1. Display the printer driver dialog box. (→P.149)
2. Click the **Utility** tab to display the **Utility** sheet.

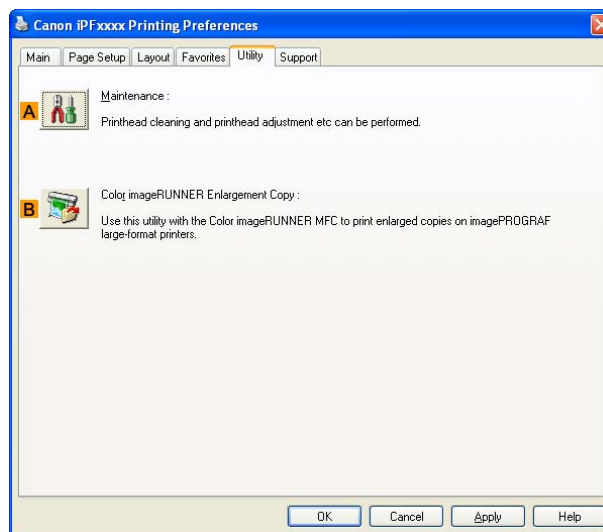

3. Click **B Color imageRUNNER Enlargement Copy** to start the Color imageRUNNER Enlargement Copy utility.
4. Use the Color imageRUNNER Enlargement Copy utility to register or modify hot folders. For instructions on registering and modifying hot folders, refer to the help file for the Color imageRUNNER Enlargement Copy utility.

Completing the scanning settings on the Color imageRUNNER.

Configure the Color imageRUNNER to send scanned originals to the hot folder. It is easy to send scanned originals to the hot folder if you assign the scanning settings and destination to a **Favorites** button on the Color imageRUNNER.

For instructions on assigning scanning settings and destinations to a **Favorites** button, refer to the setting manual, displayed by clicking **Color imageRUNNER Enlargement Copy Setup Manual** button of Color imageRUNNER Enlargement Copy utility, or refer to the Color imageRUNNER manual.

Scanning the original and print an enlargement

Follow the steps below to scan an original on the Color imageRUNNER for enlarged printing on the printer. For detailed instructions, refer to the Color imageRUNNER manual.

1. Load the original on the platen glass or document feeder of the Color imageRUNNER.
2. Press **Send** to display the screen for transmission.
3. Press **Favorites**, and then press the **Favorites** button assigned to the hot folder.
4. Press **Start** on the control panel. If you scan originals on the platen glass, after scanning all originals, press **Done** on the touch-panel display.

Scanned originals are sent to the hot folder and automatically enlarged and printed following the conditions you specified for the folder.



Note

- For details on Color imageRUNNER Enlargement Copy, refer to Color imageRUNNER Enlargement Copy Guide .

Special Settings Dialog Box (Windows)

If the printing results are not as you expected, you can change how printing is processed in the **Special Settings** dialog box.



Note

- To display the **Special Settings** dialog box, on the **Layout Sheet (Windows)** (→P.456) , click **Special Settings**.

Setting Item	Description
A FineZoom Settings	This function is used in large-format printing. Normally, choose Auto . If documents are not printed correctly on large-format media, it may help to select Yes , and if fine lines are not visible or if images are distorted when printed, it may help to select No .
B Fast Graphic Process	If image colors are inconsistent in printed documents or if lines are printed in varying thicknesses, clearing this option may help produce the expected results.
C Application Color Matching Priority	You can give applications priority in color management.

View Settings Dialog Box for the Printing Application (Windows)

In the **View Settings** dialog box, you can check details of the selected printing application.

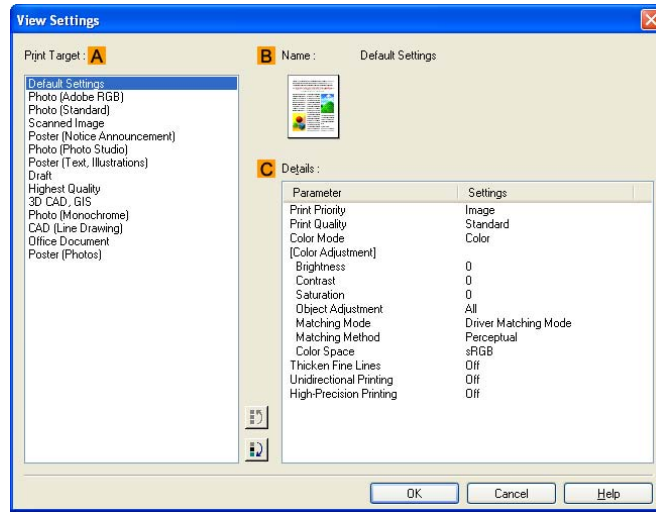

Note

- To display the **View Settings** dialog box, on the **Main Sheet (Windows)** (→P.450) , click **View Settings** by **Print Target**.

Setting Item	Description
A Print Target	Shows all Print Target options (settings items for the printing application).
B Name	Identifies the item selected in Print Target by its name and an icon.
C Details	Here, you can confirm detailed settings values for each listed item for the selected Print Target .

Mac OS X

Printer Driver Settings (Mac OS X)

For instructions on accessing the Mac OS X printer driver, refer to the following topics.

- Accessing the Printer Driver Dialog Box from Applications (Mac OS X) (→P.511)

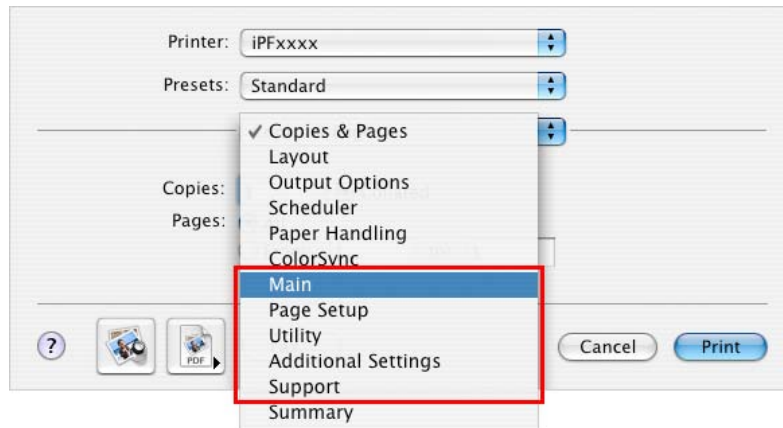

For information on the Mac OS X printer driver settings, refer to the following topics.

- Main Pane (Mac OS X) (→P.499)

You can specify the media type, color processing, print quality, print preview, and other settings. Choose **Easy Settings** to specify basic print settings based on the printing application or **Advanced Settings** to complete more detailed settings as desired.

 - Media Detailed Settings Dialog Box (Mac OS X) (→P.515)
 - View Settings Dialog Box for the Printing Application (Mac OS X) (→P.516)
 - Color Settings Pane: Color (Mac OS X) (→P.512)
 - Color Settings Pane: Monochrome (Mac OS X) (→P.514)
 - Gray Adjustment Pane (Mac OS X) (→P.504)
- Page Setup Pane (Mac OS X) (→P.501)

You can specify the page size of the original, borderless printing, enlargement or reduction, the orientation, the media size and source, and automatic cutting.
- Utility Pane (Mac OS X) (→P.503)

You can specify settings related to maintenance for the Printhead and feed amount, as well as settings for **Color imageRUNNER Enlargement Copy**.
- Additional Settings Pane (Mac OS X) (→P.505)

You can specify settings for how print jobs are sent to the printer.
- Support Pane (Mac OS X) (→P.506)

You can view support information and the user's manual.

With the **imagePROGRAF Free Layout** feature, you can arrange originals from various source applications on a single page before printing. For details, see the Free Layout Guide .

With the **imagePROGRAF Preview** feature, you can check the layout before printing and adjust layout or size settings while viewing a preview screen. For details, see the imagePROGRAF Preview Guide .

With the **Color imageRUNNER Enlargement Copy** feature, you can automatically enlarge and print scanned originals from a **Color imageRUNNER**. For details, see the Color imageRUNNER Enlargement Copy Guide .

☐ Confirming Print Settings (Mac OS X)

There are two ways to confirm what printing conditions have been specified, as follows.

- Checking a preview of the settings (→P.493)
- Checking a print preview (→P.494)

Checking a preview of the settings

A preview of the settings is displayed on the left side of the **Main**, **Page Setup**, **Utility**, and **Additional Settings** panes. By checking images and numerical values in the preview, you can confirm current settings for the page size, orientation, media source, and so on.

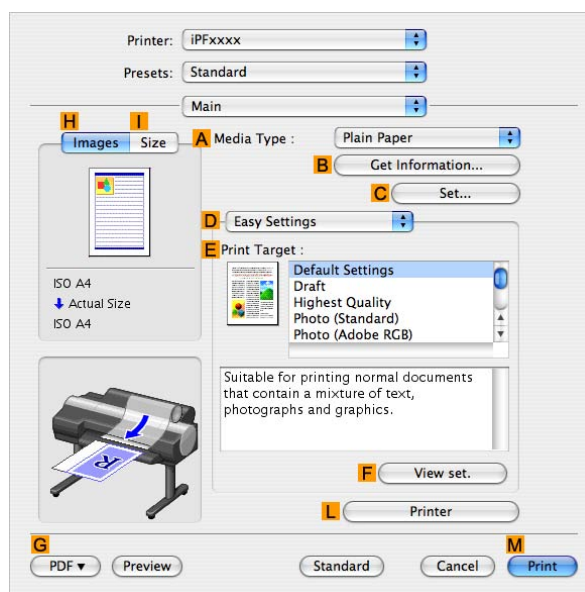

Display Area	Information Displayed
Pane displayed when the Images tab is clicked	On top, illustrations indicate the page size of the original, the paper size, orientation, layout, borderless printing selection, color mode, and other settings information. Under this, the page size, paper size, and method and percentage of enlargement or reduction is displayed.
Pane displayed when the Size tab is clicked	Paper size details are indicated numerically.
Pane with printer and paper illustrations	Illustrations indicate the media source, orientation, borderless printing selection, and other settings information.



Note

- To confirm the **Print Target** specified in **Easy Settings**, click **F View set.** on the **Main** pane to display the **View settings** dialog box.

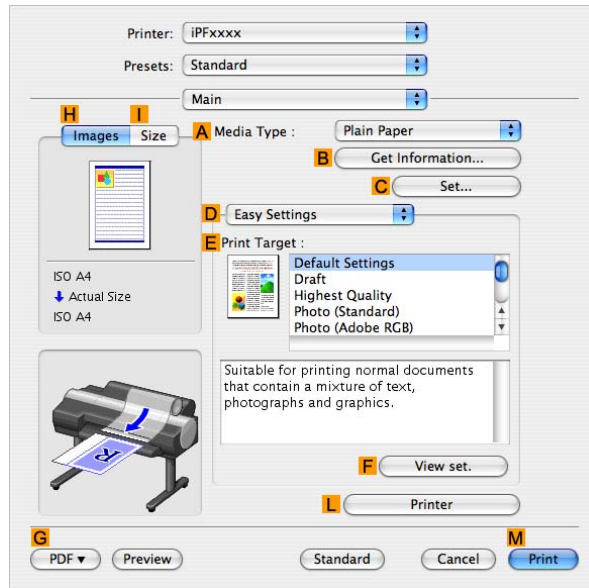

Checking a print preview

You can check an image of the original just as it will be printed.

Confirming the image of print jobs beforehand helps prevent printing errors.

For details on print previews, see “Previewing Images Before Printing (Mac OS X)”. (→P.497)

☐ Checking the Layout Before Printing

You can check the print layout on the preview screen. While viewing this screen, you can also adjust layout or size settings, and your changes will be instantly applied on the preview screen.

Preview (Macintosh)

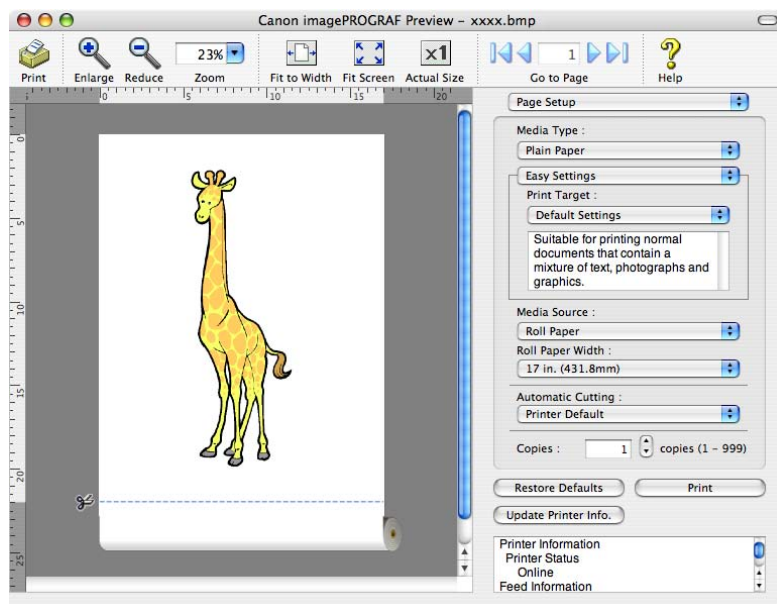

Important

- The driver must be installed from the User Software CD-ROM to use this function.

For instructions on how to check the layout before printing, refer to the following topics:

- Checking the Layout Before Printing (Mac OS X) (→P.496)

☐ Checking the Layout Before Printing (Mac OS X)

This topic describes how to check the layout before printing using the **Preview** function.

1. Choose **Print** in the application menu.
2. Click **PDF** and select **Canon imagePROGRAF Preview**.

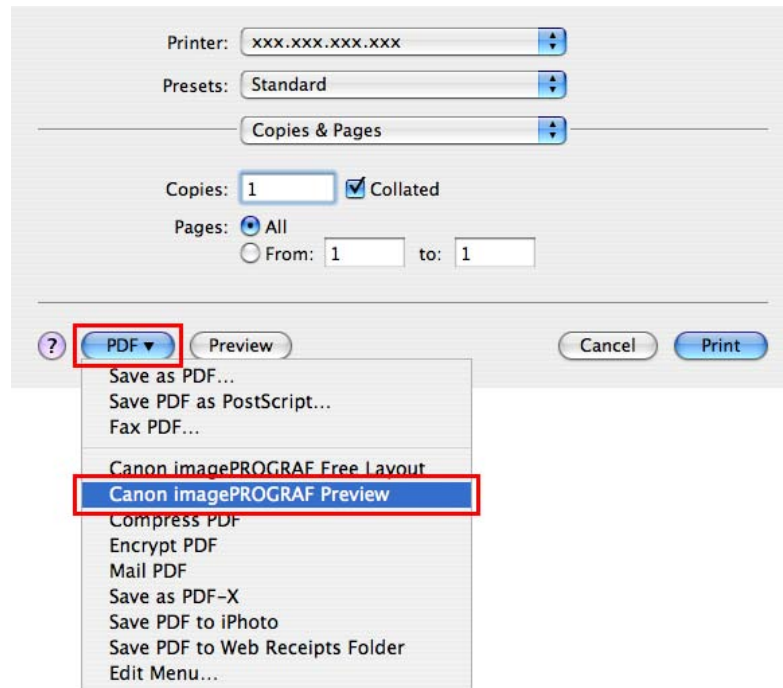

3. The **Canon imagePROGRAF Preview** window is displayed.

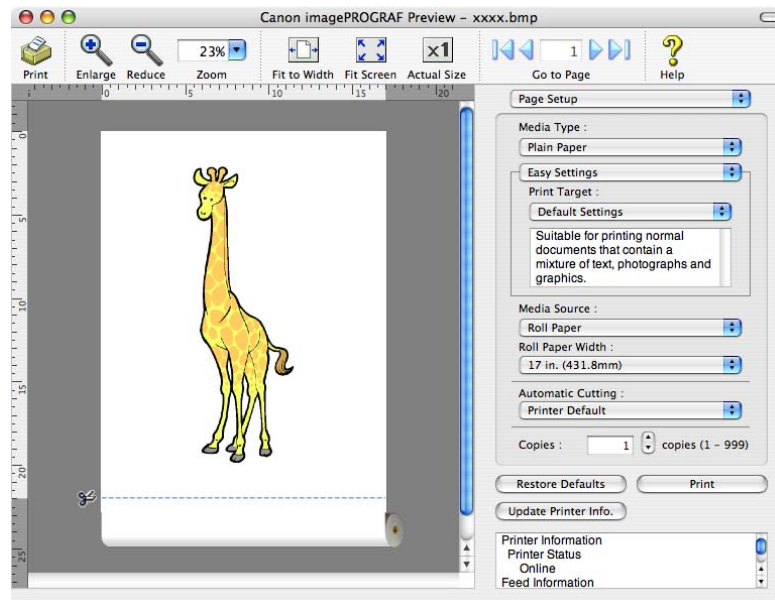

4. Check the layout and adjust settings in the **Canon imagePROGRAF Preview** window as desired.
5. Print from the **Canon imagePROGRAF Preview** menu.



Note

- For details on **imagePROGRAF Preview** functions, refer to **imagePROGRAF Preview Guide** .

Previewing Images Before Printing (Mac OS X)

This topic describes how to preview images of print jobs before actually printing them.

1. In the application menu, choose **Print**.
2. Click **Preview** to open the preview window.
3. Check the layout and other aspects of the printing image, and then click **Print** to start printing.



Note

- “Preview” is provided as a standard feature of the operating system. For details, refer to the Mac OS documentation.

☰ Paper Information on Printer Dialog Box (Mac OS X)

On the **Paper Information on Printer** dialog box, you can obtain information on the paper in the printer and configure printer driver media type setting.

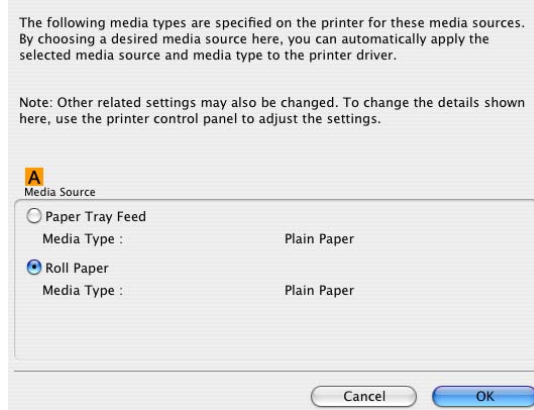

Note

- To display the **Paper Information on Printer** dialog box, on the **Main Pane** (Mac OS X) (→P.499) , click **Get Information by Media Type**.

Setting Item	Description
☰ Media Source	Shows the Media Source supported by the printer, as well as the type of paper loaded. To update the media type setting in the printer driver, select the desired Media Source option and click OK .

Main Pane (Mac OS X)

The following settings are available on the **Main** pane. For details on settings items, refer to the printer driver help.



Note

- On the **Main** pane, choose **Easy Settings** to specify basic print settings based on the print target, or switch to **Advanced Settings** to complete more detailed settings as desired.

Configuration using Easy Settings

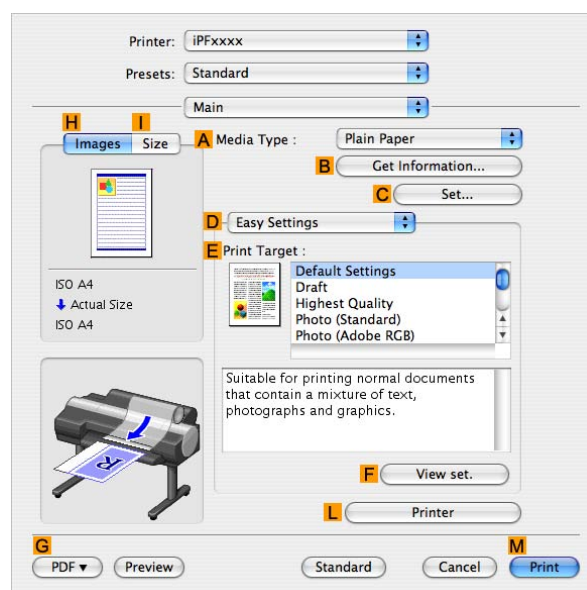

Setting Item	Description
A Media Type	Select the paper type. For information on the types of paper the printer supports, refer to the Paper Reference Guide . (→P.108)
B Get Information	Click to display the Get Information dialog box, which shows media types specified on the printer for each media source. When you select a media source, your selection is applied to the printer driver settings for the media source and media type.
C Set	Click to display the Media Detailed Settings dialog box for ink drying time and other detailed settings based on the paper type.
E Print Target	Choose presets that match the type of document to be printed. Printing Photos and Images (Windows, Mac OS X) (→P.177) Printing Line Drawings and Text (Windows, Mac OS X) (→P.181) Printing Office Documents (→P.183)
F View set.	Click to display the View settings dialog box, which enables you to confirm the settings for the selected item from the E Print Target list or change the order of items listed in E Print Target .
L Printer Information	Click to display the Printer dialog box, which indicates the ink levels and gives other information about the printer.

Configuration using Advanced Settings

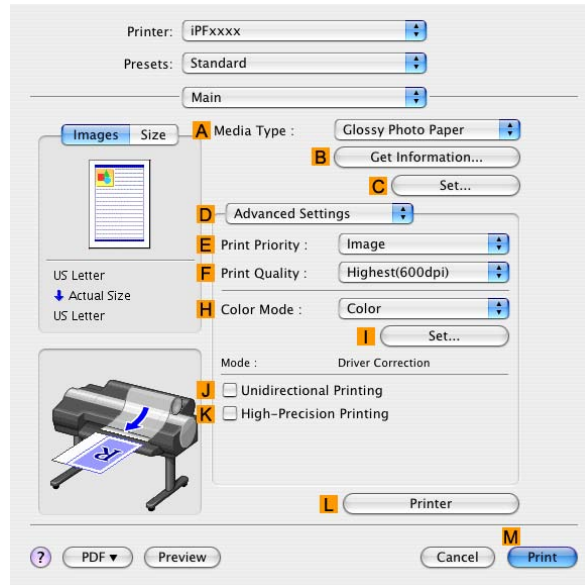

Setting Item		Description
A Media Type		Select the paper type. For information on the types of paper the printer supports, refer to the Paper Reference Guide . (→P.108)
	B Get Information	Click to display the Get Information dialog box, which shows media types specified on the printer for each media source. When you select a media source, your selection is applied to the printer driver settings for the media source and media type.
	C Set	Click to display the Media Detailed Settings dialog box for ink drying time and other detailed settings based on the paper type.
E Print Priority		Choose the graphic elements that you want to emphasize for printing. Giving Priority to Particular Graphic Elements and Colors for Printing (→P.173)
F Print Quality		Choose the level of print quality. Giving Priority to Particular Graphic Elements and Colors for Printing (→P.173)
H Color Mode		Choose the color mode. Giving Priority to Particular Graphic Elements and Colors for Printing (→P.173)
	I Set	Click to display the Color Settings dialog box for more advanced color settings. Adjusting the Color in the Printer Driver (→P.184)
J Unidirectional Printing		Although unidirectional printing is slower, it can help prevent misaligned lines and ensure better results.
K High-Precision Printing		Select this option for printing at the highest level of quality. However, this will take more time than regular printing.
L Printer Information		Click to display the Printer dialog box, which indicates the ink levels and gives other information about the printer.

Page Setup Pane (Mac OS X)

The following settings are available on the **Page Setup** pane. For details on settings items, refer to the printer driver help.

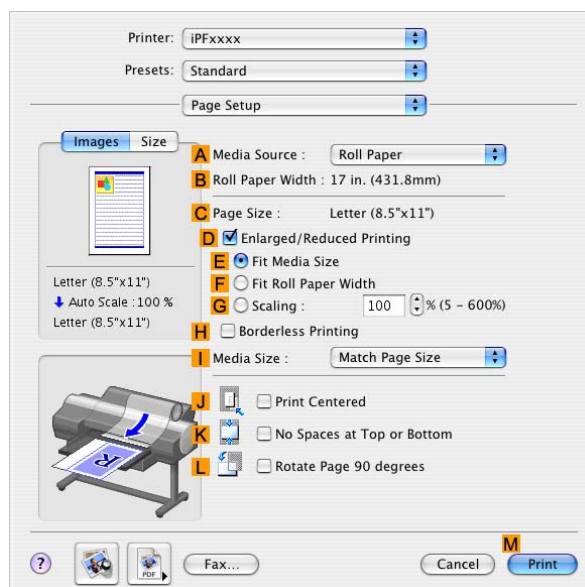

Setting Item	Description
A Media Source	Choose how paper is supplied. Options displayed in the list vary depending on the selection in A Media Type in the Main pane.
B Roll Paper Width	Displays the paper width of the roll loaded in the printer. Unknown is displayed if the printer cannot detect the roll paper width.
C Page Size	Displays the size of the original, as specified in the page settings of the application. For details on page sizes available in the application, see "Paper Sizes". (→P.113)
D Enlarged/Reduced Printing	Choose from the following options when this setting is activated. Resizing Originals to Match the Paper Size (→P.244) Resizing Originals to Fit the Roll Width (→P.245) Resizing Originals by Entering a Scaling Value (→P.246)
E Fit Media Size	Resizes the document image to match the paper size.
F Fit Roll Paper Width	Resizes the document image to match the roll width.
G Scaling	Resizes the document image based on a specified scaling value. Enter a value in a range of "5-600."
H Borderless Printing	Borderless printing is available if Roll Paper is selected in the A Media Source list. Activate this setting for borderless printing to match the size and width of the paper. Borderless Printing on Paper of Equivalent Size (→P.297) Borderless Printing by Resizing Originals to Fit the Roll Width (→P.299) Borderless Printing at Actual Size (→P.279)
I Media Size	Choose the size of the paper you will print on. Click Display all selections for Media Size to list available sizes. For details on available paper sizes, see "Paper Sizes". (→P.113)

Setting Item	Description
J Print Centered	Activate this setting to print document images in the center of the paper. Printing Originals Centered on Rolls (→P.378) Printing Originals Centered on Sheets (→P.379)
K No Spaces at Top or Bottom	Activate this setting to print the next image skipping blank areas above and below printable data in documents, which enables you to conserve the paper. Conserving Roll Paper by Printing Originals Without Top and Bottom Margins (→P.396)
L Rotate Page 90 degrees	Activate this setting to rotate the original 90 degrees before printing. Conserving Roll Paper by Rotating Originals 90 Degrees (→P.395)

Utility Pane (Mac OS X)

The following settings are available on the **Utility**pane.

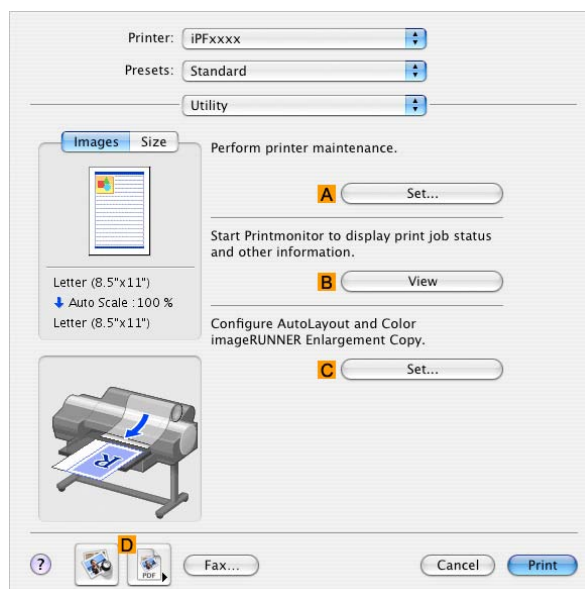

Setting Item	Description
A Set	Click to display the Printer dialog box, which offers the following maintenance for the printer. <ul style="list-style-type: none"> • Nozzle (ink ejecting outlet) cleaning • Head alignment adjustment • Feed amount adjustment
B View	Click to start imagePROGRAF Printmonitor , which enables you to view the status of print jobs.
C Set	Click to complete the settings for Auto Arrange or Color imageRUNNER Enlargement Copy (iR enlargement copy).

*1: For details, see Color imageRUNNER Enlargement Copy Guide .

Gray Adjustment Pane (Mac OS X)

The following settings are available on the **Gray Adjustment** pane.

Gray Adjustment

On the **Gray Adjustment** pane, you can adjust the color balance, brightness, contrast, and other image qualities.

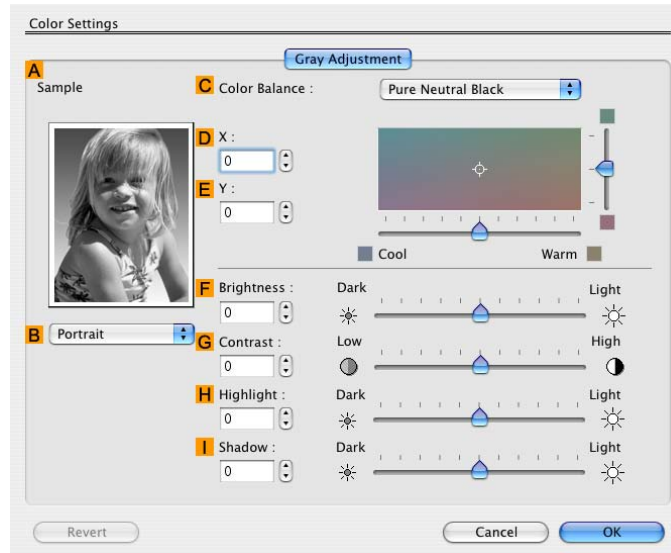

Note

- To display the **Gray Adjustment** pane, on the **Main Pane (Mac OS X)** (→P.499), select **Monochrome (Photo)** by **Color Mode** in **Advanced Settings**, and then click **Color Settings**.
- Monochrome (Photo)** is not available for all types of paper.

Setting Item	Description
A Sample	The image at left is updated to reflect any changes you make to setting items on the sheet, enabling you to check the results of adjustment.
B Sample List	Select a sample image, as desired.
C Color Balance	Click the list to select a color balance that suits the printing application.
D X	Adjust the color balance as you check the color tone in the adjustment area. You can adjust the square area in the center by clicking or dragging it. Drag the vertical or horizontal scroll bars for adjustment, as desired. You can click the arrows by the X (horizontal) and Y (vertical) boxes or enter the values directly.
E Y	
F Brightness	Adjust the overall image brightness as desired. You can adjust the brightness if the printed document is lighter or darker than the original image (that is, the original photo that was scanned or the original graphic as it appears on the computer screen).
G Contrast	Adjust the contrast of the darkest and lightest portions relative to each other, as desired. Increasing the Contrast makes images sharper, and reducing the Contrast softens images.
H Highlight	Adjust the brightness of the lightest portion.
I Shadow	Adjust the brightness of the darkest portion.

Additional Settings Pane (Mac OS X)

The following settings are available on the **Additional Settings** pane.

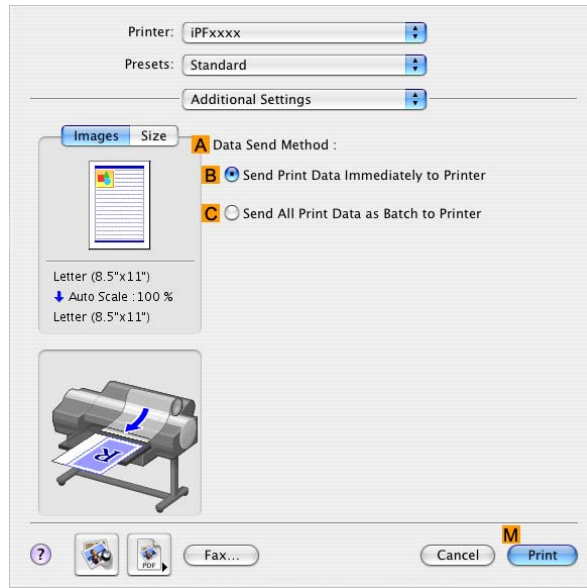

Setting Item	Description
A Data Send Method	Choose how printing data is sent to the printer. <ul style="list-style-type: none"> • B Send Print Data Immediately to Printer • C Send All Print Data as Batch to Printer

Support Pane (Mac OS X)

On the **Support** pane, you can view support information and the user's manual.

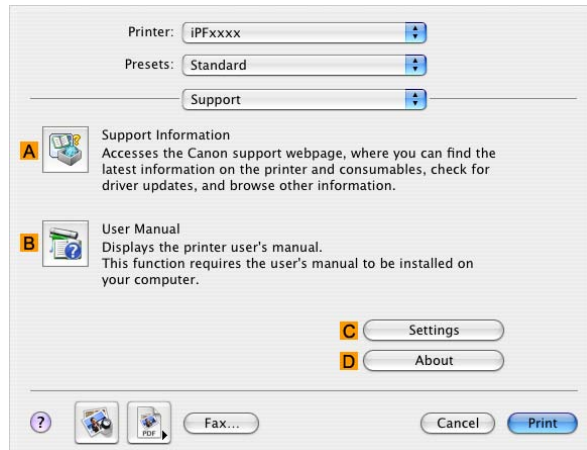

Button	Corresponding Utility
A Support Information	Click to access the Canon support webpage, where you can find the latest information on the printer and consumables, check for printer driver updates, and browse other information.
B User Manual	Click to view the printer user's manual. This function requires the user's manual to be installed on your computer.
C Settings	The settings can be saved as a file. Click to display the Export dialog box, which enables you to specify where to save the file.
D About	You can display version information for the printer driver.

Using Favorites (Mac OS X)

You can use the **Presets** function in Mac OS X for favorite-based printing.



Note

- In the printing dialog box, click **Save As** in the **Presets** list to save the current print settings. This is a standard feature of the operating system. For details, refer to the Mac OS documentation.

Printing Adobe RGB Images (Mac OS X)

This topic describes how to print Adobe RGB images based on the following example.

- Document: Adobe RGB image created in Photoshop
- Page size: 10×12 inches (254.0×304.8 mm)
- Paper: Roll
- Paper type: Glossy Photo Paper
- Roll Width: 10 inches (254.0 mm)



Important

- Do not set up color-matching in Photoshop.
- In the printer driver, specify **Driver Correction** and set **Color Space** to **Adobe RGB**.

1. In Photoshop, create an image in the Adobe RGB color space.



Note

- Photoshop CS2 is used in this example.
- For instructions on creating Adobe RGB images, refer to the Photoshop documentation.

2. Choose **Print with Preview** from the Photoshop menu to display the **Print** dialog box.

3. Make sure the setting mode is **Color Management**.

4. In the **Color Handling** list in **Options**, click **No Color Management**.

5. Click **Print**.

6. Access the **Main** pane.

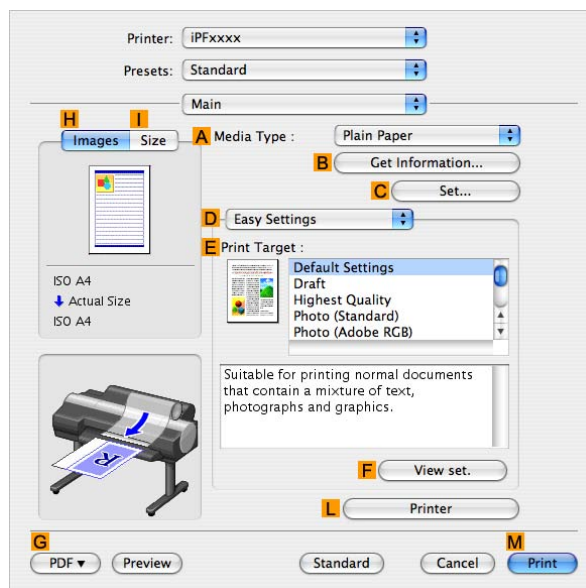

7. In the **A Media Type** list, select the type of paper that is loaded. In this case, click Glossy Photo Paper.

8. Click **D Advanced Settings** to switch the print mode.

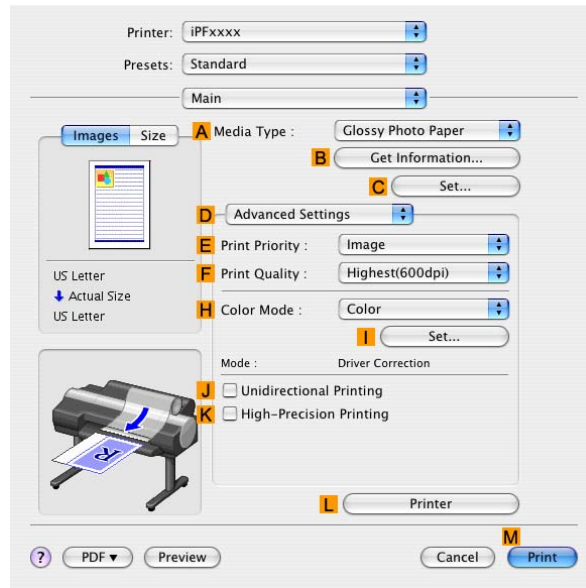

9. Click **Image** in the **E Print Priority** list.

10. Select the print quality in the **F Print Quality** list.



Note

- Options displayed in the **F Print Quality** list vary depending on the paper type.

11. Click **Color** in the **H Color Mode** list.

12. Click **I Set** to display the **Color Settings** dialog box.

13. Click **Matching** to display the **Matching** pane.

14. In **Mode**, click **Driver Correction**.

15. In **Color Space**, click **Adobe RGB**.

16. Click **OK** to close the **Color Settings** dialog box.

17. Access the **Page Setup** pane.

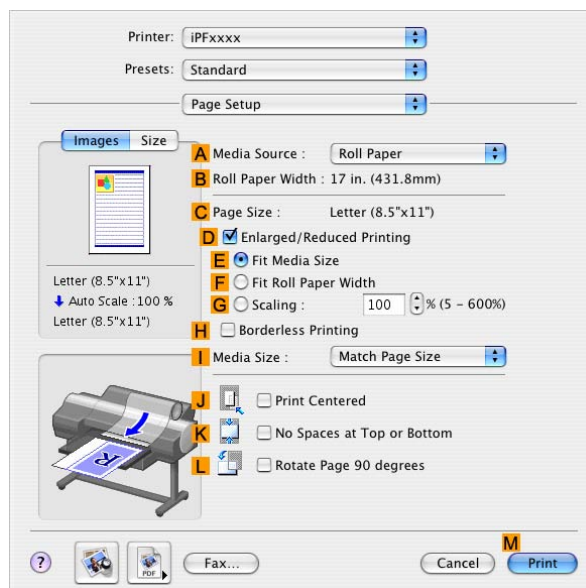

18. Click **Roll Paper** in the **A Media Source** list.
19. Make sure the width of the loaded roll paper is displayed in the **B Roll Paper Width** list-here, **10-in. Roll (254.0mm)**.



Note

- If the width of the loaded roll is not displayed in **B Roll Paper Width**, click **L Printer Information** on the **Main** pane and update the printer information.

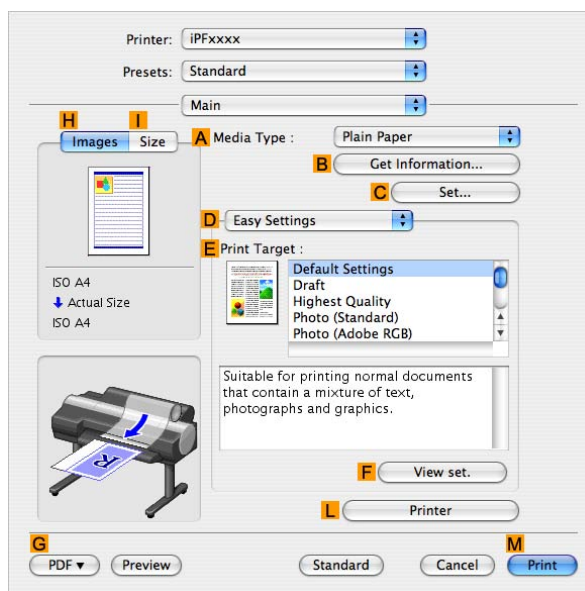

20. Make sure the page size as specified in Photoshop is shown in **C Page Size** -in this case, **10"x12"**.
21. Confirm the print settings, and click **M Print** to start printing.



Note

- For tips on confirming print settings, see “Confirming Print Settings (Mac OS X)”. (→P.493)

imagePROGRAF Printmonitor (Macintosh)

imagePROGRAF Printmonitor is a utility for checking the printer status and managing print jobs.

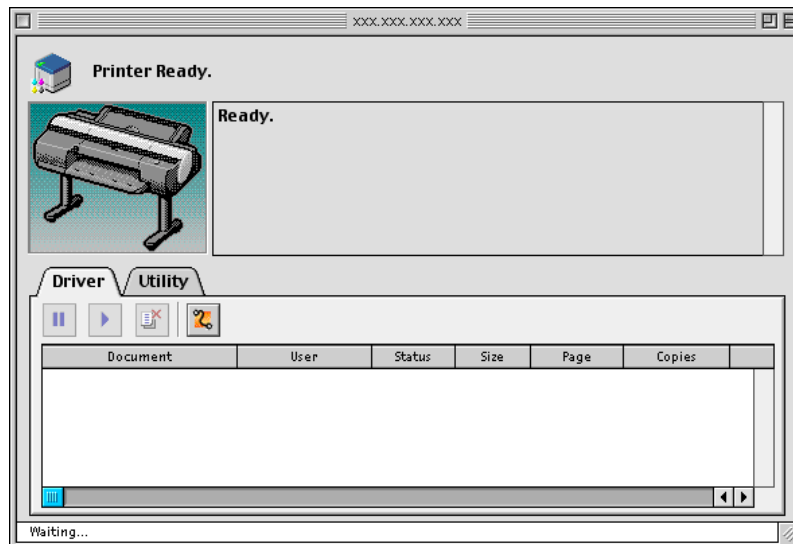
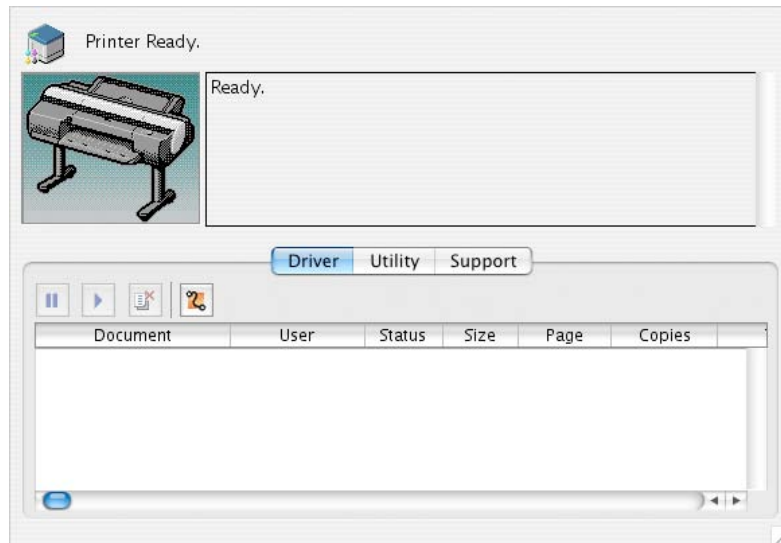

- Printer status can be checked in real time on a computer monitor.
- You can check the status of print jobs, cancel jobs, and manage them as needed.
- If a printer error occurs, you can investigate the corrective action immediately.
- You can also set up automatic email notification of any printer problems or errors to email addresses you designate in advance.



Note

- If the status of the desired printer is not shown in **imagePROGRAF Printmonitor**, select the printer again as follows.
 1. Make sure the printer is on and connected to the network or to a local port.
 2. In the **Printer** menu, select the name of the desired printer.
After the printer is detected, the printer status is shown.
 3. If information about the printer is not shown in step 2, choose **Search Printer** in the **Printer** menu.
 4. Select the zone to search (or select ***(My Zone)** if no zones have been set up) and click the **Search** button.
Printer names listed in the **Printer** menu are updated with the printers that are now detected.
 5. In the **Printer** menu, select the name of the desired printer.
After the printer is detected, the printer status is shown.

Accessing the Printer Driver Dialog Box from Applications (Mac OS X)

1. In the application software, select **Print** from the **File** menu to display the dialog box for printing conditions.



Note

- This dialog box includes basic printing options and enables you to choose the printer, specify the range of pages, number of copies, and so on.

2. Select the printer in the **Printer** list.

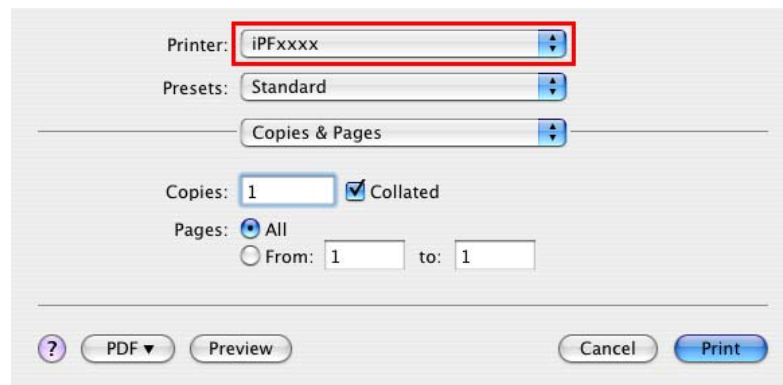

3. Click **Print** to start printing.

As shown in the following illustration, you can switch to other panes in this dialog box to complete settings for various methods of printing, including enlarged and reduced printing, borderless printing, and so on.

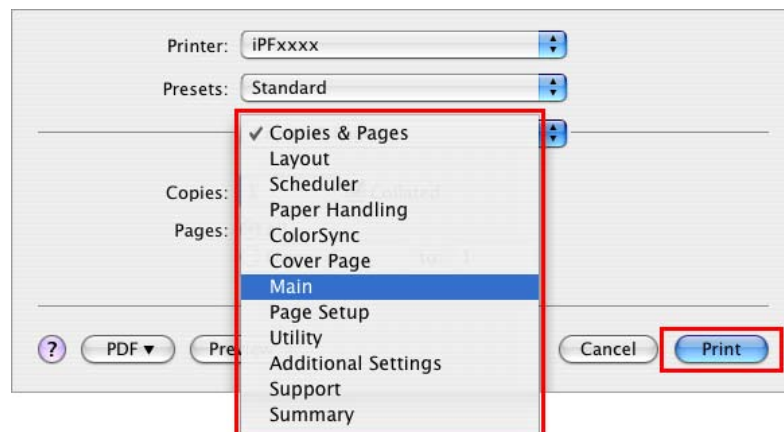

Color Settings Pane: Color (Mac OS X)

In general, make any needed adjustments to the color of documents in the application used to create them. However, if the color tone as printed is not as you expected, you can also adjust the color in the printer driver.

Color Adjustment pane: color

If the color tone as printed is not as you expected, you can adjust it on the **Color Adjustment** pane.

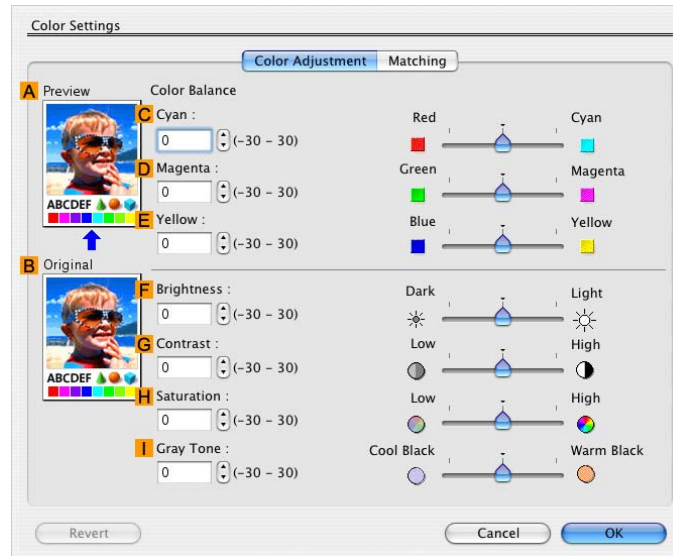

Note

- To display the **Color Adjustment** pane, on the **Main Pane** (Mac OS X) (→P.499), click **Color Settings** by **Color Mode** in **Advanced Settings**.

Setting Item	Description
A Preview	The image at left is updated to reflect any changes you make to setting items on the pane, enabling you to check the results of adjustment.
B Original	The image at right shows the original state before adjustment. You can compare it to the Preview image.
C Cyan	Correct color tones by adjusting the levels of each color.
D Magenta	
E Yellow	
F Brightness	Adjust the overall image brightness as desired. You can adjust the brightness if the printed document is lighter or darker than the original image (that is, the original photo that was scanned or the original graphic as it appears on the computer screen).
G Contrast	Adjust the contrast of the darkest and lightest portions relative to each other, as desired. Increasing the Contrast makes images sharper, and reducing the Contrast softens images.
H Saturation	Adjust the color intensity as desired. Increasing the Saturation setting makes colors more vivid, and reducing the Saturation makes colors more subdued.
I Gray Tone	Adjust the color tone of grays as desired. Choose Cool Black (tinged with blue), Warm Black (tinged with red), and so on.

**Note**

- For details on settings items, see “Adjusting the Color in the Printer Driver”. (→P.184)

Matching pane

On the **Matching** pane, you can specify color matching, to compensate for differences in the appearance of colors on various devices.

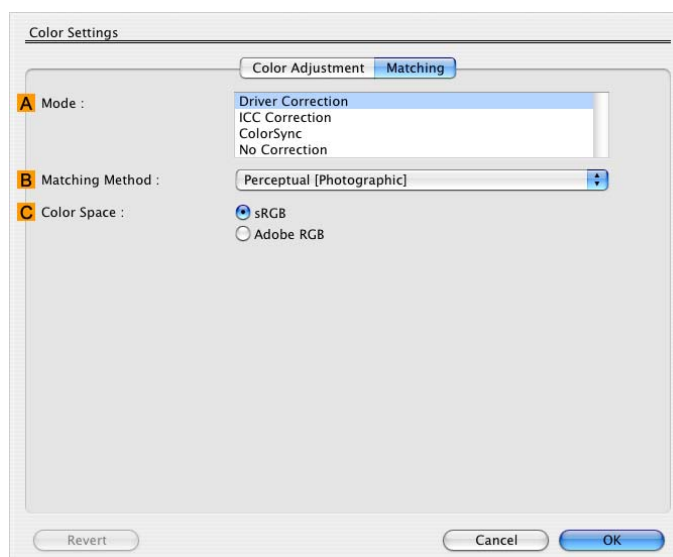
**Note**

- To display the **Matching** pane, on the **Main Pane** (Mac OS X) (→P.499) , click **Color Settings** by **Color Mode** in **Advanced Settings**, and then click **Matching**.

Setting Item	Description
A Matching Mode	Select the color matching mode to use, as desired.
B Matching Method	Select the matching method that suits the document to be printed. Various Matching Method options are available depending on your selection in Matching .
C Color Space	Select the applicable color space as desired.

**Note**

- For details on settings items, see “Adjusting the Color in the Printer Driver”. (→P.184)

Color Settings Pane: Monochrome (Mac OS X)

The following settings are available on the **Color Settings** pane for monochrome printing.

Color Adjustment pane: monochrome

On the **Color Adjustment** pane for monochrome printing, you can adjust the brightness and contrast.

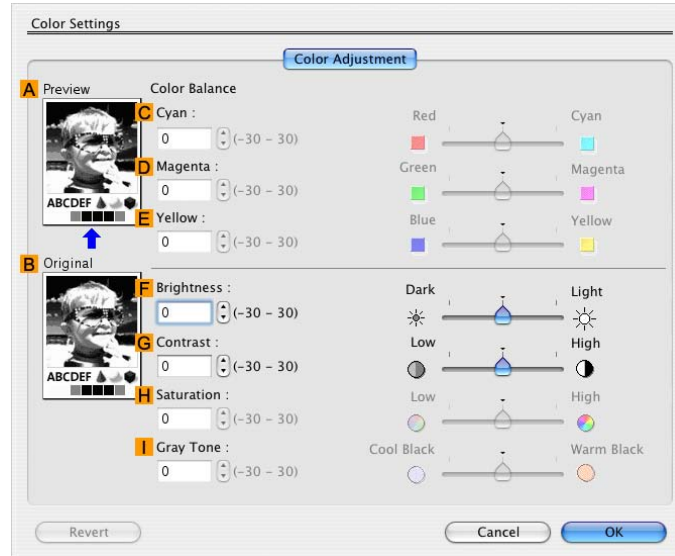

Note

- To display the **Color Adjustment** pane, on the **Main Pane** (Mac OS X) (→P.499), click **Color Settings** in **Advanced Settings**.

Setting Item	Description
A Preview	The image at left is updated to reflect any changes you make to setting items on the pane, enabling you to check the results of adjustment.
B Original	The image at right shows the original state before adjustment. You can compare it to the Preview image.
C Cyan	Not available.
D Magenta	
E Yellow	
F Brightness	Adjust the overall image brightness as desired. You can adjust the brightness if the printed document is lighter or darker than the original image (that is, the original photo that was scanned or the original graphic as it appears on the computer screen).
G Contrast	Adjust the contrast of the darkest and lightest portions relative to each other, as desired. Increasing the Contrast makes images sharper, and reducing the Contrast softens images.
H Saturation	Not available.
I Gray Tone	Not available.



Note

- For details on settings items, see “Adjusting the Color in the Printer Driver”. (→P.184)

Media Detailed Settings Dialog Box (Mac OS X)

The **Media Detailed Settings** dialog box offers the following settings. For details on settings items, refer to the printer driver help.

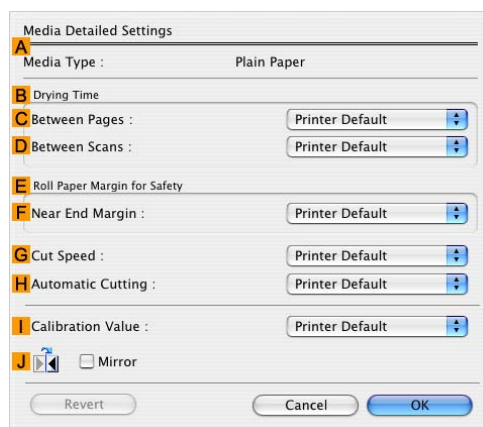

Note

- To display the **Media Detailed Settings** dialog box, on the **Main Pane** (Mac OS X) (→P.499), click **Settings by Media Type**.

Setting Item	Description
A Media Type	Select the paper type. For information on the types of paper the printer supports, refer to the Paper Reference Guide . (→P.108)
B Drying Time	Specify the time that the printer waits for ink to dry, as needed. The Drying Time setting is only valid for rolls. (→P.135)
C Between Pages	Specify the time the printer waits after printing a page until ejecting the paper, as needed.
D Between Scans	Specify the time the printer waits after printing a line on the page until printing the next line, as needed.
E Roll Paper Margin for Safety	You can specify the length of a margin on the leading edge of paper to ensure that paper susceptible to curling is held firmly against the Platen .
F Near End Margin	Specify the length of the Near End Margin (the leading edge margin) of the roll, as needed.
G Cut Speed	Select the speed of automatic cutting, as needed. You can adjust this setting if paper is not cut well when automatic cutting is used.
H Automatic Cutting	You can activate or deactivate Automatic Cutting and printing of cut lines, as desired. In this list, specify Yes , No , or Print Cut Guideline .
I Calibration Value	You can specify whether to apply the results of calibration performed on the printer to image processing.
J Mirror	Specify whether to print a mirror image, as needed. Select this option to print a version of the document or image with the left and right sides inverted.

View Settings Dialog Box for the Printing Application (Mac OS X)

In the **View Settings** dialog box, you can check details of the selected printing application.

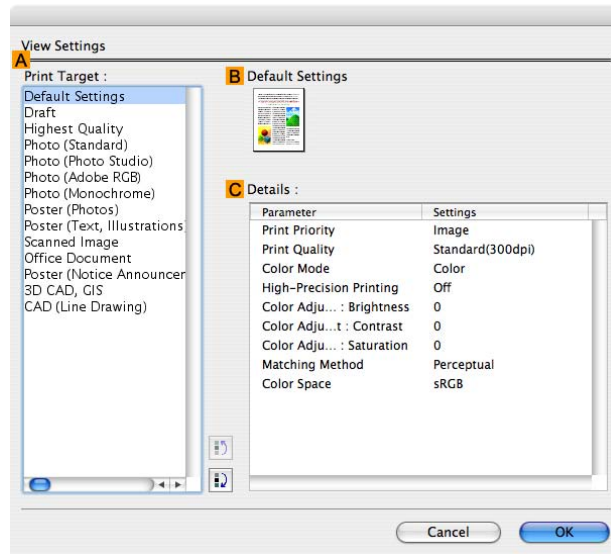

Note

- To display the **View Settings** dialog box, on the **Main Pane (Mac OS X)** (→P.499) , click **View Settings** by **Print Target**.

Setting Item	Description
A Print Target	Shows all Print Target options (settings items for the printing application).
B Name	Identifies the item selected in Print Target by its name and an icon.
C Details	Here, you can confirm detailed settings values for each item selected in the Print Target list.

Mac OS 9

Printer Driver Settings (Mac OS 9)

For instructions on accessing the Mac OS 9 printer driver, refer to the following topics.

- Accessing the Printer Driver Dialog Box from Applications (Mac OS 9) (→P.535)

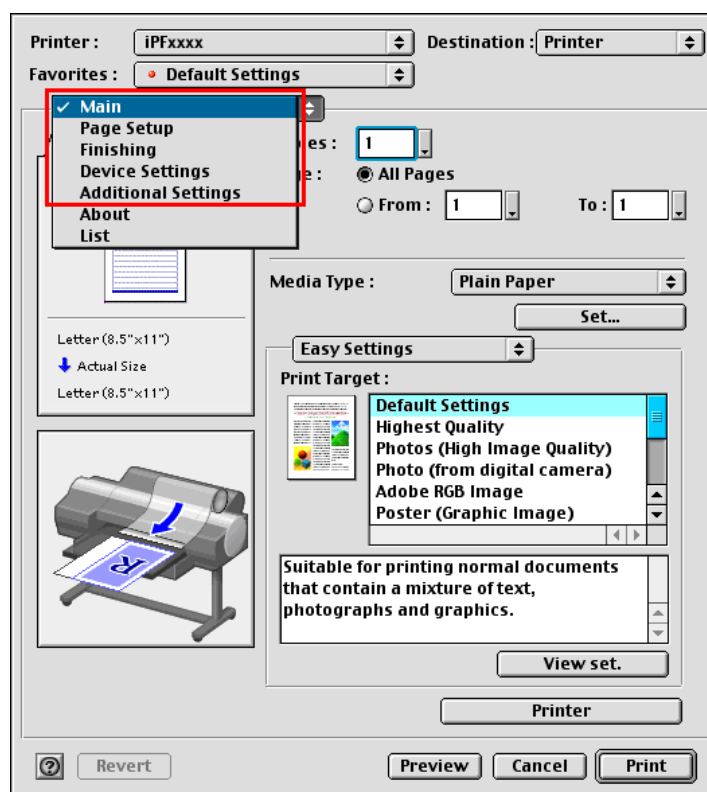

For information on the Mac OS 9 printer driver settings, refer to the following topics.

- Main Pane (Mac OS 9) (→P.521)

You can specify the number of copies, page range, media type, color processing, print quality, and print preview. Choose **Easy Settings** to specify basic print settings based on the printing application or **Advanced Settings** to complete more detailed settings as desired.

 - Media Detailed Settings Dialog Box (Mac OS 9) (→P.542)
 - View Settings Dialog Box for the Printing Application (Mac OS 9) (→P.544)
 - Color Settings Pane: Color (Mac OS 9) (→P.537)
 - Color Settings Pane: Monochrome (Mac OS 9) (→P.540)
- Page Setup Pane (Mac OS 9) (→P.523)

You can specify the amount of enlargement or reduction, borderless printing, media size, and page layout.
- Finishing Pane (Mac OS 9) (→P.525)

You can specify the media source, watermarks, and orientation.
- Device Settings Pane (Mac OS 9) (→P.527)

You can perform maintenance for the Printhead or feed amount.

 - Special Settings Dialog Box (Mac OS 9) (→P.543)
- Additional Settings Pane (Mac OS 9) (→P.528)

You can specify settings for background printing, how print jobs are sent to the printer, and notification after printing.

☐ Confirming Print Settings (Mac OS 9)

There are two ways to confirm what printing conditions have been specified, as follows.

- Checking a preview of the settings (→P.518)
- Checking a print preview (→P.519)

Checking a preview of the settings

A preview of the settings is displayed on the left side of the **Main**, **Page Setup**, **Finishing**, **Utility**, and **Additional Settings** panes. By checking images and numerical values in the preview, you can confirm current settings for the page size, orientation, media source, and so on.

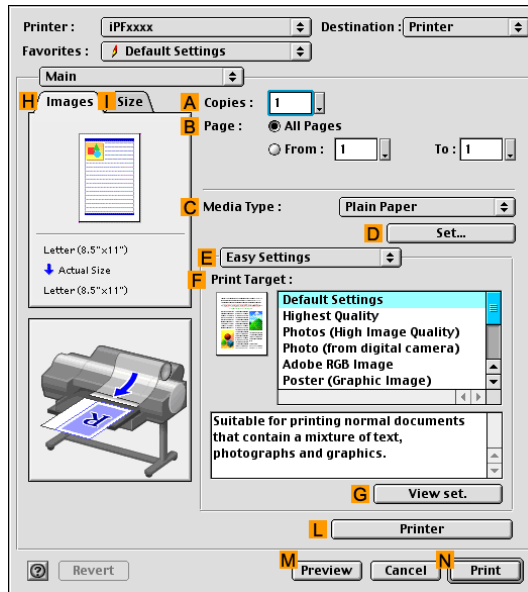

Display Area	Information Displayed
Pane displayed when the H Images tab is clicked	On top, illustrations indicate the page size of the original, the paper size, orientation, layout, borderless printing selection, color mode, and other settings information. Under this, the page size, paper size, and method and percentage of enlargement or reduction is displayed.
Pane displayed when the I Size tab is clicked	Paper size details are indicated numerically.
Pane with printer and paper illustrations	Illustrations indicate the media source, orientation, borderless printing selection, and other settings information.



Note

- To confirm the **Print Target** specified in **Easy Settings**, click **G View set.** on the **Main** pane to display the **View set.** dialog box.

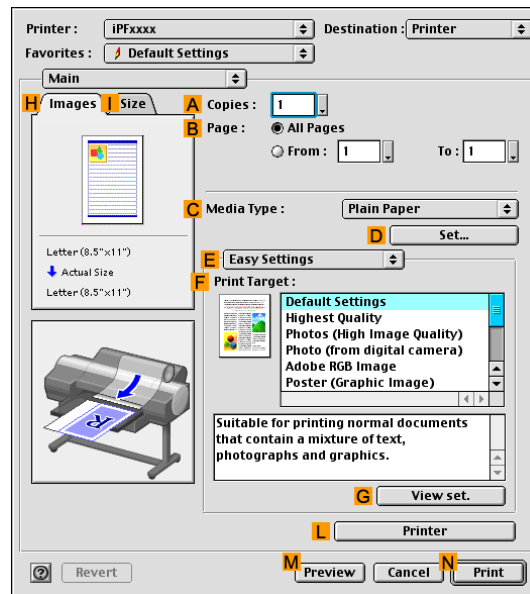

Checking a print preview

You can check an image of the original just as it will be printed.

Confirming the image of print jobs beforehand helps prevent printing errors.

For details on print previews, see “Previewing Images Before Printing (Mac OS 9)”. (→P.520)

Previewing Images Before Printing (Mac OS 9)

This topic describes how to preview images of print jobs before actually printing them.

1. In the application menu, choose **Print**.
2. Click **Preview** to open the preview window.
3. Check the layout and other aspects of the printing image, and then click **Print this page** to start printing.



Note

- “Preview” is provided as a standard feature of the operating system. For details, refer to the Mac OS documentation.

Main Pane (Mac OS 9)

The following settings are available on the **Main** pane. For details on settings items, refer to the printer driver help.



Note

- On the Main pane, choose **Easy Settings** to specify basic print settings based on the printing application, or switch to **Advanced Settings** to complete more detailed settings as desired.

Configuration using Easy Settings

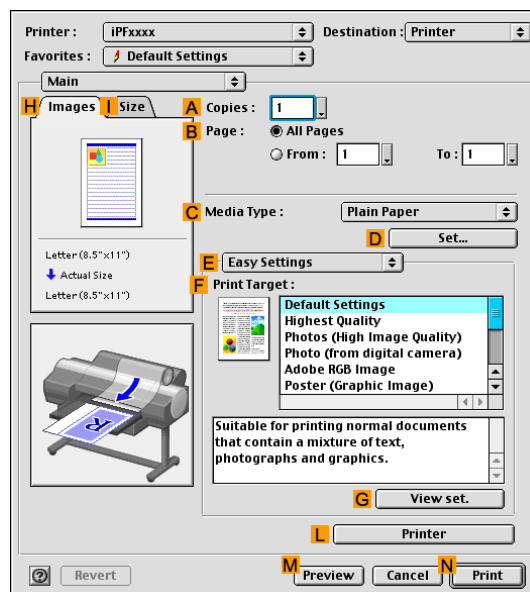

Setting Item	Description
A Copies	Enter the number of copies to print, in a range of "1-999."
B Page	Specify the pages to print. <ul style="list-style-type: none"> All Pages From and To
C Media Type	Select the paper type. For information on the types of paper the printer supports, refer to the Paper Reference Guide . (→P.108)
D Set	Click to display the Media Detailed Settings dialog box for ink drying time and other detailed settings based on the paper type.
F Print Target	Choose presets that match the type of document to be printed. Printing Photos and Images (Mac OS 9) (→P.179) Printing Line Drawings and Text (Mac OS 9) (→P.182) Printing Office Documents (→P.183)
G View set.	Click to display the View set. dialog box, which enables you to confirm the settings for the selected item from the F Print Target list or change the order of items listed in F Print Target .
L Printer	Click to display the Printer Information dialog box, which indicates the ink levels and gives other information about the printer.

Configuration using Advanced Settings

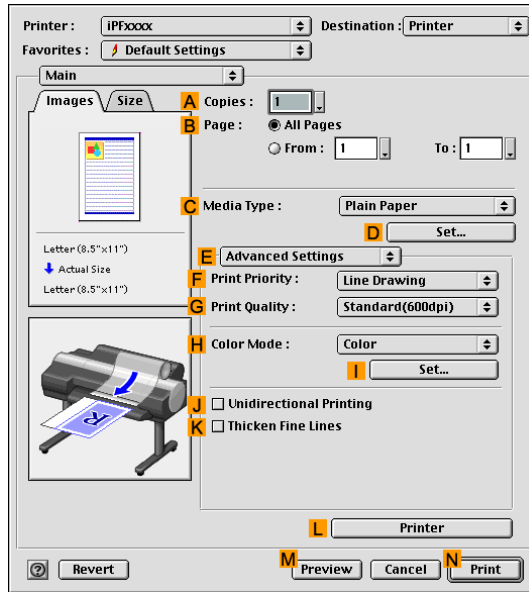

Setting Item	Description
A Copies	Enter the number of copies to print, in a range of "1-999."
B Page	Specify the pages to print. <ul style="list-style-type: none"> • All Pages • From and To
C Media Type	Select the paper type. For information on the types of paper the printer supports, refer to the Paper Reference Guide . (→P.108)
D Set	Click to display the Media Detailed Settings dialog box for ink drying time and other detailed settings based on the paper type.
F Print Priority	Choose the graphic elements that you want to emphasize for printing. Giving Priority to Particular Graphic Elements and Colors for Printing (→P.173)
G Print Quality	Choose the level of print quality. Giving Priority to Particular Graphic Elements and Colors for Printing (→P.173)
H Color Mode	Choose the color mode. Giving Priority to Particular Graphic Elements and Colors for Printing (→P.173)
I Set	Click to display the Color Settings dialog box for more advanced color settings. Adjusting the Color in the Printer Driver (→P.184)
J Unidirectional Printing	Although unidirectional printing is slower, it can help prevent misaligned lines and ensure better results. Depending on the printing conditions, unidirectional printing may be the default setting even if you do not choose it. In this case, the printing speed will not change if you activate the setting.
K Thicken Fine Lines	Activate this option to print fine lines more distinctly.
L Printer	Click to display the Printer Information dialog box, which indicates the ink levels and gives other information about the printer.

Page Setup Pane (Mac OS 9)

The following settings are available on the **Page Setup** pane. For details on settings items, refer to the printer driver help.

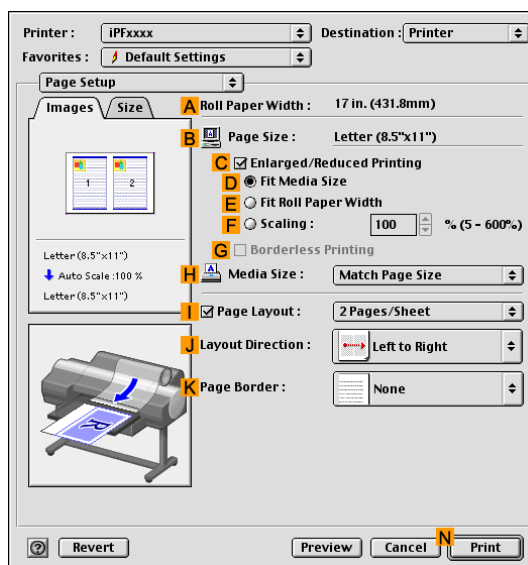

Setting Item	Description
A Roll Paper Width	Displays the paper width of the roll loaded in the printer.
B Page Size	Displays the page size, as specified in the source application. For details on paper sizes available from the source application, see "Paper Sizes". (→P.113)
C Enlarged/Reduced Printing	Choose from the following options when this setting is activated. Resizing Originals to Match the Paper Size (→P.244) Resizing Originals to Fit the Roll Width (→P.245) Resizing Originals by Entering a Scaling Value (→P.246)
D Fit Media Size	Scales the document image to match the paper size.
E Fit Roll Paper Width	Scales the document image to match the roll width.
F Scaling	Resizes the document image based on a specified scaling value. Enter a value in a range of "5-600."
G Borderless Printing	Borderless printing is available if Roll Paper is selected from the A Media Source list in the Finishing Pane (Mac OS 9). (→P.525) Activate this setting for borderless printing to match the size and width of the paper. Borderless Printing on Paper of Equivalent Size (→P.297) Borderless Printing by Resizing Originals to Fit the Roll Width (→P.299) Borderless Printing at Actual Size (→P.279)
H Media Size	Choose the size of the paper you will print on. For details on available paper sizes, see "Paper Sizes". (→P.113)
I Page Layout	Activate this option to select the page layout when printing multiple pages per sheet.(*1) Printing Multiple Pages Per Sheet (→P.355) Printing Posters in Sections (→P.356)

Setting Item	Description
J Layout Direction	This setting is available when I Page Layout is selected. Here, you can specify the orientation of multiple pages to be printed on a single sheet.
K Page Border	This setting is available when I Page Layout is selected. Here, you can specify the type of boundary line around each page of multiple pages printed on a single sheet.

*1: Selecting poster layout from the **I Page Layout** list displays a check box for specifying the pages to print.

Finishing Pane (Mac OS 9)

The following settings are available on the **Finishing** pane. For details on settings items, refer to the printer driver help.

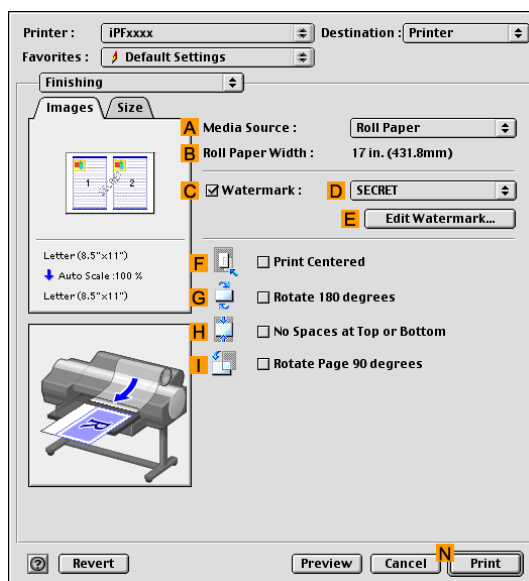

Setting Item	Description
A Media Source	You can choose the media source. Options displayed in the list vary depending on the selection in C Media Type in the Main Pane (Mac OS 9). (→P.521)
B Roll Paper Width	Displays the paper width of the roll loaded in the printer. Unknown is displayed if the printer cannot detect the roll paper width.
C Watermark	Activating this option makes two settings available, D Watermarks and E Edit Watermark . Printing With Watermarks (→P.419)
D Watermarks	Lists the provided watermarks. Choose the watermark to print.
E Edit Watermark	Click to display the Edit Watermark dialog box for creating your own, original watermark.
F Print Centered	Choose this option to print the document images in the center of the paper. Printing Originals Centered on Rolls (→P.378) Printing Originals Centered on Sheets (→P.379)
G Rotate 180 degrees	Activate this setting to rotate the document image by 180 degrees before printing.
H No Spaces at Top or Bottom	Activate this setting to print the next image skipping blank areas above and below printable data in documents, which enables you to conserve the paper. Conserving Roll Paper by Printing Originals Without Top and Bottom Margins (→P.396)
I Rotate Page 90 degrees	Activate this setting to rotate the document image by 90 degrees before printing. Conserving Roll Paper by Rotating Originals 90 Degrees (→P.395)

Gray Adjustment Pane (Mac OS 9)

The following settings are available on the **Gray Adjustment** pane.

Gray Adjustment

On the **Gray Adjustment** pane, you can adjust the color balance, brightness, contrast, and other image qualities.

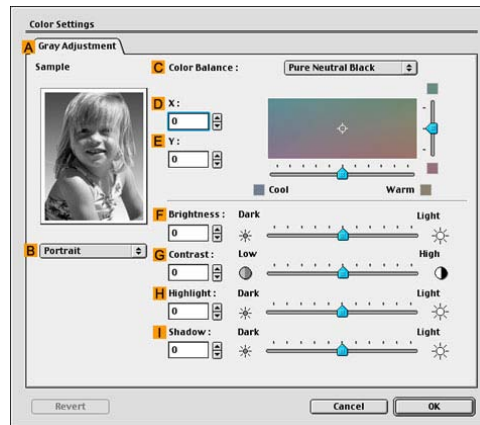

Note

- To display the **Gray Adjustment** pane, on the **Main Pane** (Mac OS 9) (→P.521), select **Monochrome (Photo)** by **Color Mode** in **Advanced Settings**, and then click **Color Settings**.
- Monochrome (Photo)** is not available for all types of paper.

Setting Item	Description
A Sample	The image at left is updated to reflect any changes you make to setting items on the sheet, enabling you to check the results of adjustment.
B Sample List	Select a sample image, as desired.
C Color Balance	Click the list to select a color balance that suits the printing application.
D X	Adjust the color balance as you check the color tone in the adjustment area. You can adjust the square area in the center by clicking or dragging it. Drag the vertical or horizontal scroll bars for adjustment, as desired. You can click the arrows by the X (horizontal) and Y (vertical) boxes or enter the values directly.
E Y	
F Brightness	Adjust the overall image brightness as desired. You can adjust the brightness if the printed document is lighter or darker than the original image (that is, the original photo that was scanned or the original graphic as it appears on the computer screen).
G Contrast	Adjust the contrast of the darkest and lightest portions relative to each other, as desired. Increasing the Contrast makes images sharper, and reducing the Contrast softens images.
H Highlight	Adjust the brightness of the lightest portion.
I Shadow	Adjust the brightness of the darkest portion.

Device Settings Pane (Mac OS 9)

The following settings are available on the **Device Settings** pane.

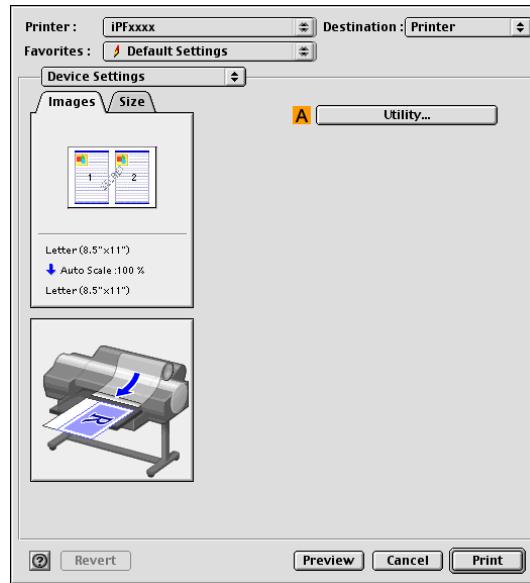

Setting Item	Description
A Utility	<p>Click to display the Printer Information dialog box, which offers the following maintenance for the printer.</p> <ul style="list-style-type: none"> • Nozzle (ink ejecting outlet) cleaning • Head alignment adjustment • Feed amount adjustment

Additional Settings Pane (Mac OS 9)

The following settings are available on the **Additional Settings** pane. For details on settings items, refer to the printer driver help.

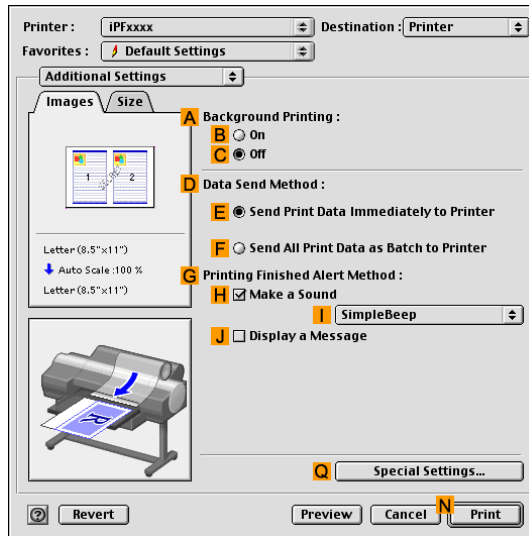

Setting Item	Description
A Background Printing	Choose the printing method. Activate this setting by clicking B On to print in the background. Deactivate this setting by clicking C Off to print in the foreground.
D Data Send Method	Choose how printing data is sent to the printer. <ul style="list-style-type: none"> E Send Print Data Immediately to Printer F Send All Print Data as Batch to Printer
G Printing Finished Alert Method	Choose how to notify when printing is finished. Specify how to be notified when printing is finished, by a tone or a message.
H Make a Sound	Activate this setting to be notified by a tone when printing is finished. You can also choose a different tone.
J Display a Message	Activate this setting to be notified by a dialog box when printing is finished.

Using Favorites (Mac OS 9)

This topic describes how to register favorites and print using favorite settings.

Registering a favorite

Follow the steps below to save the current print settings as a favorite.

1. Select the printer in **Chooser**.
2. Choose **Print** in the application menu.
3. Complete the print settings.
4. In the **Favorites** list, click **Add Favorite** to display the **Add Favorite** dialog box.
5. Complete the following settings in the **Add Favorite** dialog box.
 - Enter a desired name in **Name**, such as “Photos for Presentations” or “Monthly Report.”
 - In **Comment**, enter a description of the favorite to be added.
6. Click **OK** to close the **Add Favorite** dialog box.

The favorite you have added is now displayed in **Favorites**.



Note

- To edit the name of an existing favorite or comment, click **Edit Favorite** in the **Favorites** list to display the **Edit Favorite** dialog box.
- To save a favorite as a file, click **Export** and specify the file to save.

Printing using the favorite

Follow the steps below to print using the favorite you have registered.

1. Select the printer in **Chooser**.
2. Choose **Page Setup** from the application menu to display the **Page Attribute** dialog box.

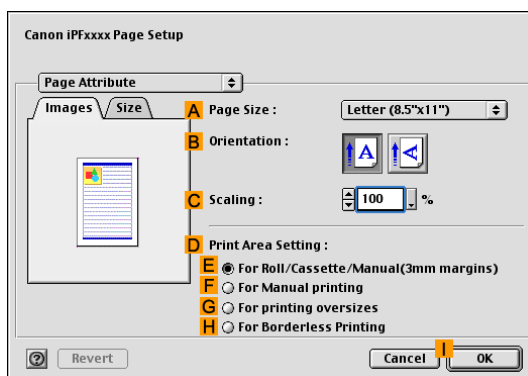

3. Choose the original size in the **A Page Size** list.
4. Click **I OK** to close the dialog box.
5. In the application menu, choose **Print**.
6. In the **Favorites** list, choose the favorite you registered.



Note

- To import a favorite, click **Import** and specify the favorite file.
- If you select a favorite and edit it, an icon is displayed at left of the name to indicate that the settings have been changed. For details, refer to the printer driver help.

7. Confirm the print settings, and then click **Print** to start printing.



Note

- For tips on confirming print settings, see “Confirming Print Settings (Mac OS 9)”. (→P.518)

Printing Adobe RGB Images (Mac OS 9)

This topic describes how to print Adobe RGB images based on the following example.

- Document: Adobe RGB image created in Photoshop
- Page size: 10×12 inches (254.0×304.8 mm)
- Paper: Roll
- Paper type: Glossy Photo Paper
- Roll width: 10 inches (254.0 mm)



Important

- Do not set up color-matching in Photoshop.
- In the printer driver, specify **Driver Matching Mode** and set **Color Space** to **Adobe RGB**.

1. In Photoshop, create an image in the Adobe RGB color space.



Note

- Photoshop CS2 is used in this example.
- For instructions on creating Adobe RGB images, refer to the Photoshop documentation.

2. In the Photoshop menu, choose **Print**.

3. Make sure the **Main** pane is displayed.

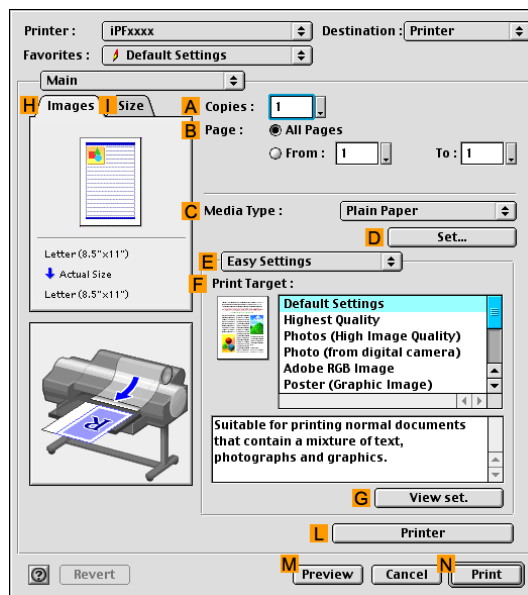

4. In the **C Media Type** list, select the type of paper that is loaded. In this case, click Glossy Photo Paper.

5. Click **E Advanced Settings** to switch the print mode.

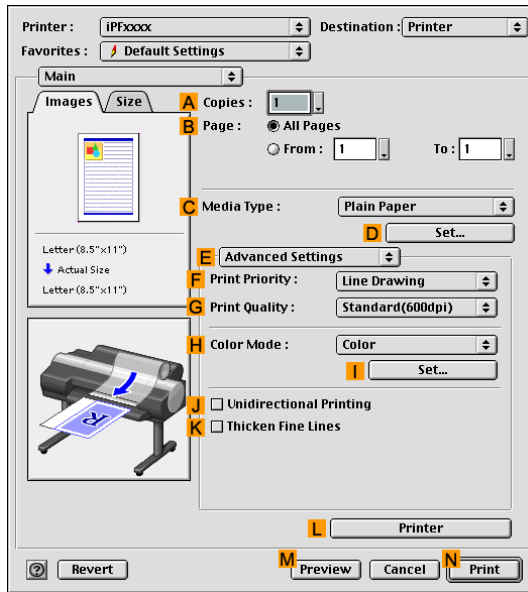

6. Click **Image** in the **F Print Priority** list.

7. Select the print quality in the **G Print Quality** list.



Note

- Options displayed in the **G Print Quality** list vary depending on the paper type.

8. Click **Color** in the **H Color Mode** list.

9. Click **I Set** to display the **Color Settings** dialog box.

10. Click **Matching** to display the **Matching** pane.

11. In **Mode**, click **Driver Correction**.

12. In **Color Space**, click **Adobe RGB**.

13. Click **OK** to close the **Color Settings** dialog box.

14. Access the **Page Setup** pane.

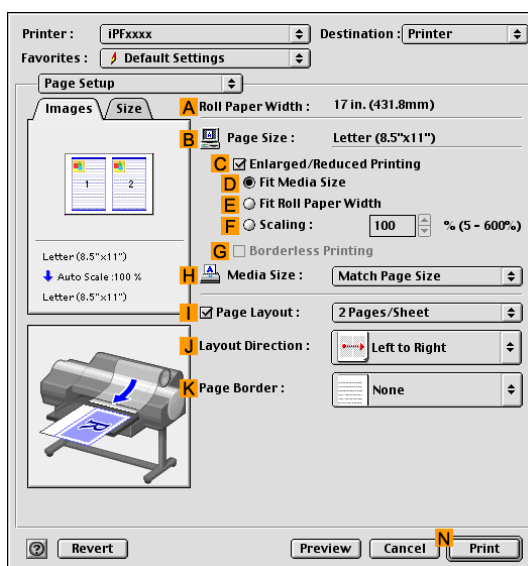

15. Make sure the page size as specified in Photoshop is shown in **B Page Size** -in this case, **10"x12"**.

16. Access the **Finishing** pane.

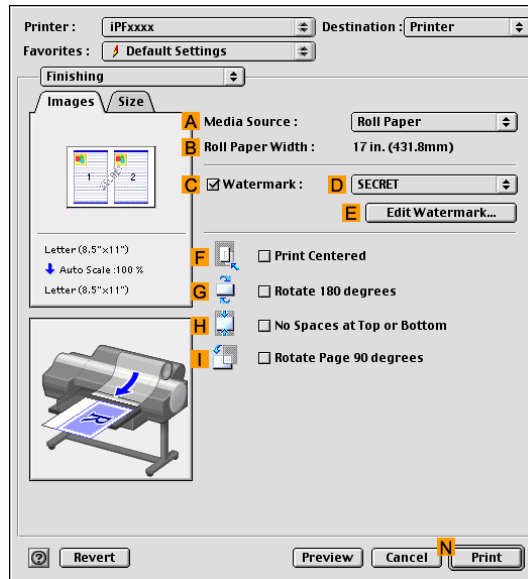

17. Click **Roll Paper** in the **A Media Source** list.

18. Make sure the width of the loaded roll paper is displayed in the **B Roll Paper Width** list—here, **10-in. Roll (254.0mm)**.



Note

- If the width of the roll loaded in the printer is not shown in the **B Roll Paper Width** list, click the **L Printer** in the **Main** pane to update the printer information.

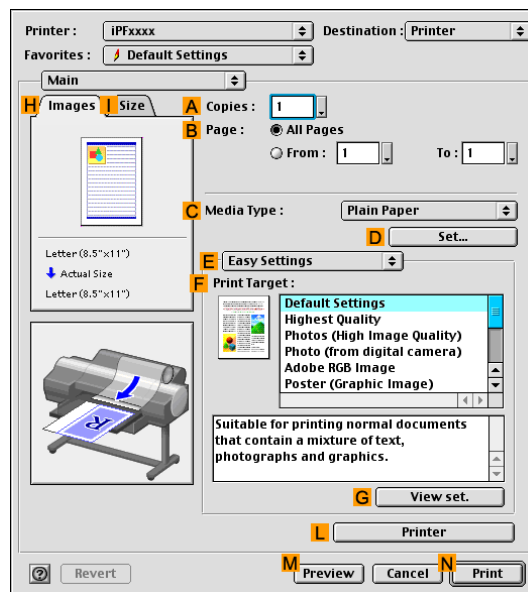

19. Confirm the print settings, and click **N Print** to start printing.



Note

- For tips on confirming print settings, see “Confirming Print Settings (Mac OS 9)”. (→P.518)

imagePROGRAF Printmonitor (Macintosh)

imagePROGRAF Printmonitor is a utility for checking the printer status and managing print jobs.

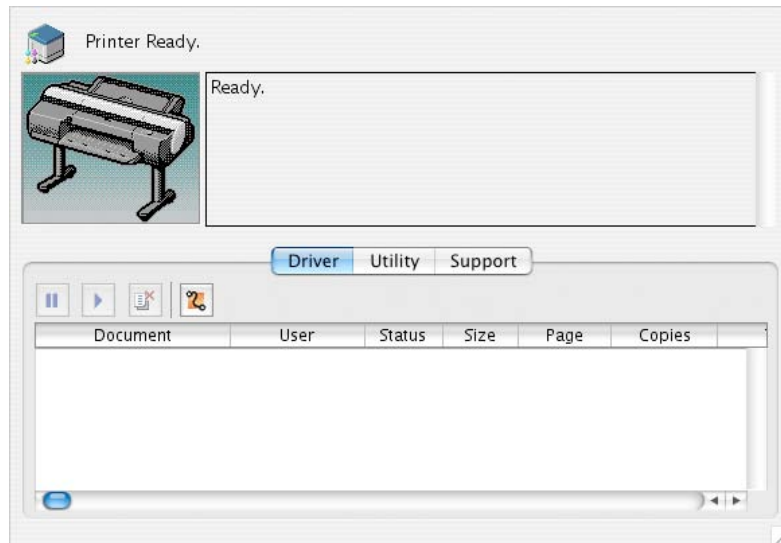

- Printer status can be checked in real time on a computer monitor.
- You can check the status of print jobs, cancel jobs, and manage them as needed.
- If a printer error occurs, you can investigate the corrective action immediately.
- You can also set up automatic email notification of any printer problems or errors to email addresses you designate in advance.



Note

- If the status of the desired printer is not shown in **imagePROGRAF Printmonitor**, select the printer again as follows.
 1. Make sure the printer is on and connected to the network or to a local port.
 2. In the **Printer** menu, select the name of the desired printer.
After the printer is detected, the printer status is shown.
 3. If information about the printer is not shown in step 2, choose **Search Printer** in the **Printer** menu.
 4. Select the zone to search (or select ***(My Zone)** if no zones have been set up) and click the **Search** button.
Printer names listed in the **Printer** menu are updated with the printers that are now detected.
 5. In the **Printer** menu, select the name of the desired printer.
After the printer is detected, the printer status is shown.

Accessing the Printer Driver Dialog Box from Applications (Mac OS 9)

1. In the application software, select **Print** from the **File** menu to display the dialog box for printing conditions.



Note

- This dialog box includes basic printing options and enables you to choose the printer, specify the range of pages, number of copies, and so on.

2. Select the printer in the **Printer** list.

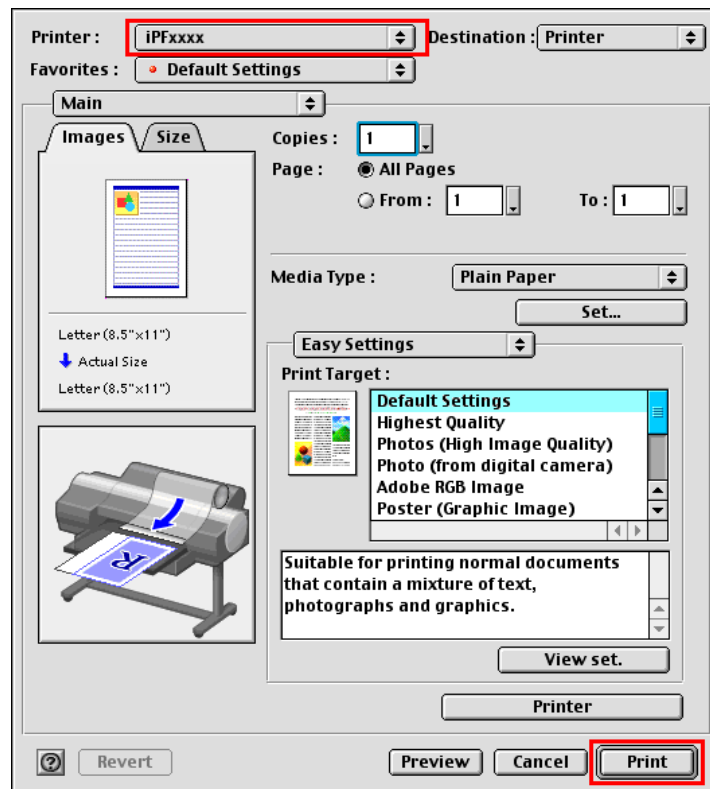

3. Click **Print** to start printing.

As shown in the following illustration, you can switch to other panes in this dialog box to complete settings for various methods of printing, including enlarged and reduced printing, borderless printing, and so on.

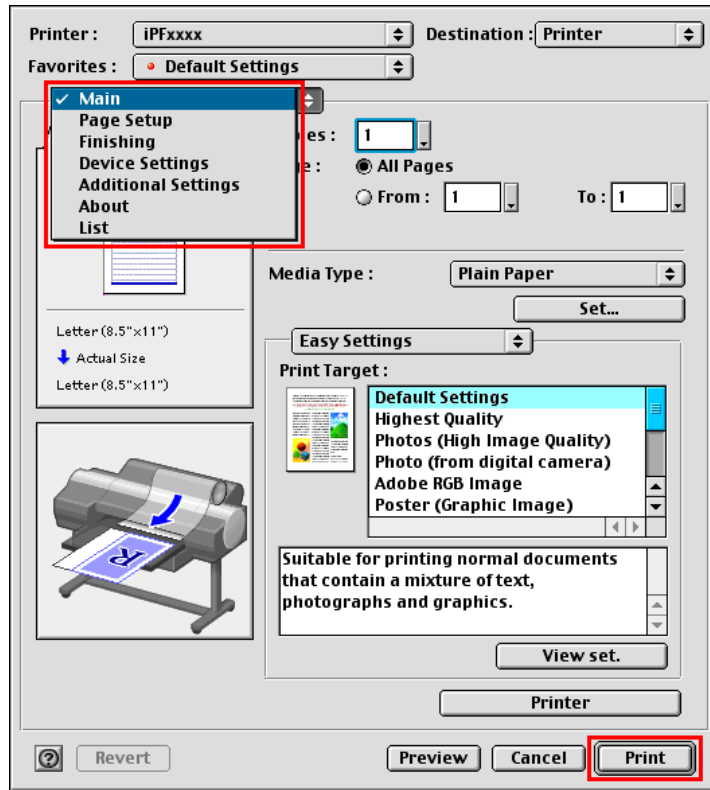

Color Settings Pane: Color (Mac OS 9)

In general, make any needed adjustments to the color of documents in the application used to create them. However, if the color tone as printed is not as you expected, you can also adjust the color in the printer driver.

Color Adjustment pane: color

If the color tone as printed is not as you expected, you can adjust it on the **Color Adjustment** pane.

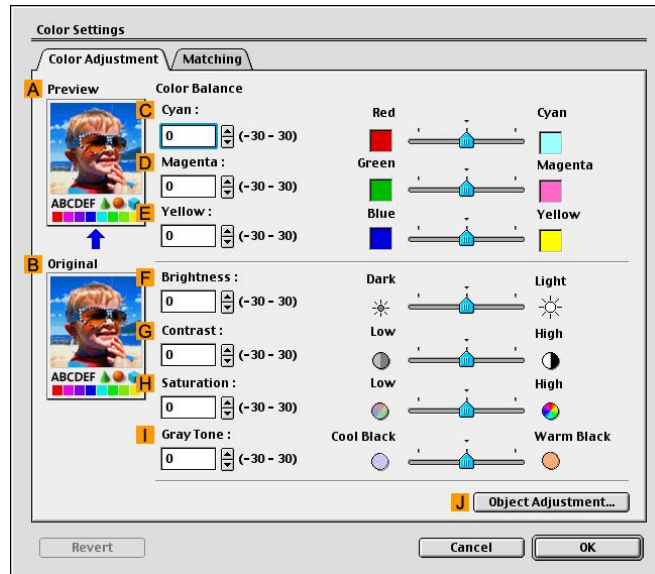

Note

- To display the **Color Adjustment** pane, on the **Main Pane** (Mac OS 9) (→P.521), click **Color Settings** by **Color Mode** in **Advanced Settings**.

Setting Item	Description
A Preview	The image at left is updated to reflect any changes you make to setting items on the pane, enabling you to check the results of adjustment.
B Original	The image at right shows the original state before adjustment. You can compare it to the Preview image.
C Cyan	Correct color tones by adjusting the levels of each color.
D Magenta	
E Yellow	
F Brightness	Adjust the overall image brightness as desired. You can adjust the brightness if the printed document is lighter or darker than the original image (that is, the original photo that was scanned or the original graphic as it appears on the computer screen).
G Contrast	Adjust the contrast of the darkest and lightest portions relative to each other, as desired. Increasing the Contrast makes images sharper, and reducing the Contrast softens images.
H Saturation	Adjust the color intensity as desired. Increasing the Saturation setting makes colors more vivid, and reducing the Saturation makes colors more subdued.

Setting Item	Description
I Gray Tone	Adjust the color tone of grays as desired. Choose Cool Black (tinged with blue), Warm Black (tinged with red), and so on.
J Object Adjustment	Select this option to display the Object Adjustment dialog box, in which you can specify objects subject to color adjustment.



Note

- For details on settings items, see “Adjusting the Color in the Printer Driver”. (→P.184)

Object Adjustment dialog box

In the **Object Adjustment** dialog box, you can specify what type of print jobs to apply color adjustment to. If an original comprises images, graphics, and text, you can specify which portion to apply color adjustment to.

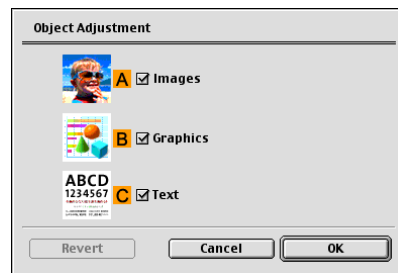

Note

- To display the **Object Adjustment** dialog box, click **Object Adjustment** on the **Color Adjustment** pane.

Setting Item	Description
A Image	Select this option to apply color adjustment to image areas, such as photos.
B Graphics	Select this option to apply color adjustment to graphics, such as lines and circles.
C Text	Select this option to apply color adjustment to text.

Matching pane

On the **Matching** pane, you can specify color matching, to compensate for differences in the appearance of colors on various devices.

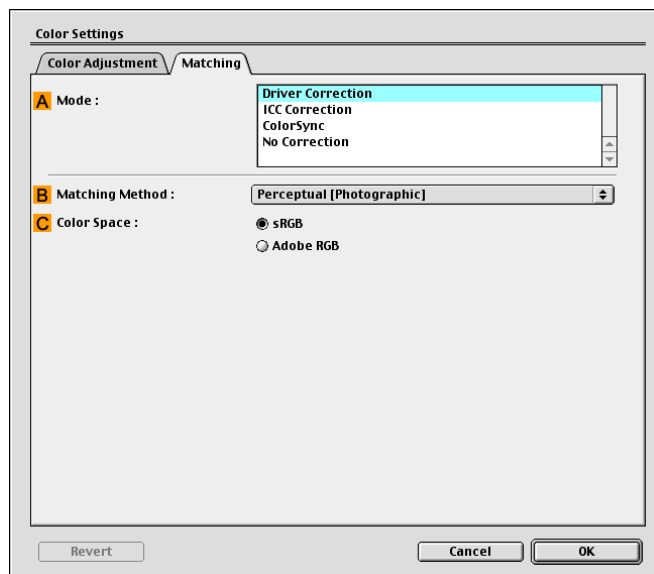

Note

- To display the **Matching** pane, on the **Main Pane** (Mac OS 9) (→P.521), click **Color Settings** by **Color Mode** in **Advanced Settings**, and then click **Matching**.

Setting Item	Description
A Matching Mode	Select the color matching mode to use, as desired.
B Matching Method	Select the matching method that suits the document to be printed. Various Matching Method options are available depending on your selection in Matching .
C Color Space	Select the applicable color space as desired.



Note

- For details on settings items, see “Adjusting the Color in the Printer Driver”. (→P.184)

Color Settings Pane: Monochrome (Mac OS 9)

The following settings are available on the **Color Settings** pane for monochrome printing.

Color Adjustment pane: monochrome

On the **Color Adjustment** pane for monochrome printing, you can adjust the brightness and contrast.

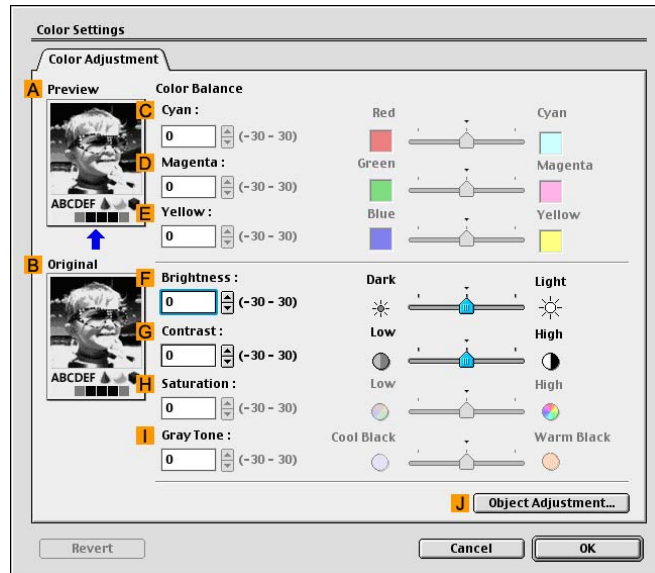

Note

- To display the **Color Adjustment** pane, on the **Main Pane** (Mac OS 9) (→P.521), click **Color Settings** by **Color Mode** in **Advanced Settings**.

Setting Item	Description
A Preview	The image above is updated to reflect any changes you make to setting items on the right of this pane, enabling you to check the results of adjustment.
B Original	The image on the bottom shows the original state before adjustment. You can compare it to the Preview image.
C Cyan	Not available.
D Magenta	
E Yellow	
F Brightness	Adjust the overall image brightness as desired. You can adjust the brightness if the printed document is lighter or darker than the original image (that is, the original photo that was scanned or the original graphic as it appears on the monitor).
G Contrast	Adjust the contrast of the darkest and lightest portions relative to each other, as desired. Increasing the Contrast makes images sharper, and reducing the Contrast softens images.
H Saturation	Not available.
I Gray Tone	Not available.
J Object Adjustment	Select this option to display the Object Adjustment dialog box, in which you can specify objects subject to color adjustment.



Note

- For details on settings items, see “Adjusting the Color in the Printer Driver”. (→P.184)

Object Adjustment dialog box

In the **Object Adjustment** dialog box, you can specify what type of print jobs to apply color adjustment to. If an original comprises images, graphics, and text, you can specify which portion to apply color adjustment to.

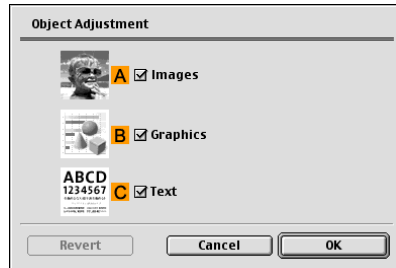

Note

- To display the **Object Adjustment** dialog box, on the **Color Adjustment** pane, click **Object Adjustment**.

Setting Item	Description
A Image	Select this option to apply color adjustment to image areas, such as photos.
B Graphics	Select this option to apply color adjustment to graphics, such as lines and circles.
C Text	Select this option to apply color adjustment to text.

Media Detailed Settings Dialog Box (Mac OS 9)

The **Media Detailed Settings** dialog box offers the following settings. For details on settings items, refer to the printer driver help.

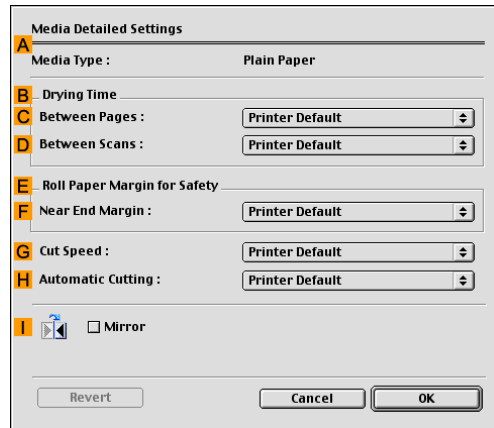

Note

- To display the **Media Detailed Settings** dialog box, on the **Main Pane** (Mac OS 9) (→P.521), click **Settings by Media Type**.

Setting Item	Description
A Media Type	Select the paper type. For information on the types of paper the printer supports, refer to the Paper Reference Guide . (→P.108)
B Drying Time	Specify the time that the printer waits for ink to dry, as needed. The Drying Time setting is only valid for rolls. (→P.135)
C Between Pages	Specify the time the printer waits after printing a page until ejecting the paper, as needed.
D Between Scans	Specify the time the printer waits after printing a line on the page until printing the next line, as needed.
E Roll Paper Margin for Safety	You can specify the length of a margin on the leading edge of paper to ensure that paper susceptible to curling is held firmly against the Platen .
F Near End Margin	Specify the length of the Near End Margin (the leading edge margin) of the roll, as needed.
G Cut Speed	Select the speed of automatic cutting, as needed. Adjust this setting if paper is not cut well when automatic cutting is used.
H Automatic Cutting	You can activate or deactivate Automatic Cutting and printing of cut lines, as desired. In this list, you can specify Yes or No and Print Cut Guideline .
I Mirror	Specify whether to print a mirror image, as needed. Select this option to print a version of the document or image with the left and right sides inverted.

Special Settings Dialog Box (Mac OS 9)

If the printing results are not as you expected, you can change how printing is processed in the **Special Settings** dialog box.

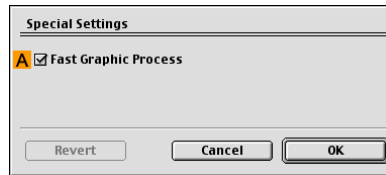

Note

- To display the **Special Settings** dialog box, on the **Additional Settings** Pane (Mac OS 9) (→P.528) , click **Special Settings**.

Setting Item	Description
Fast Graphic Process	If image colors are inconsistent in printed documents or if lines are printed in varying thicknesses, clearing this option may help produce the expected results.

View Settings Dialog Box for the Printing Application (Mac OS 9)

In the **View Settings** dialog box, you can check details of the selected printing application.

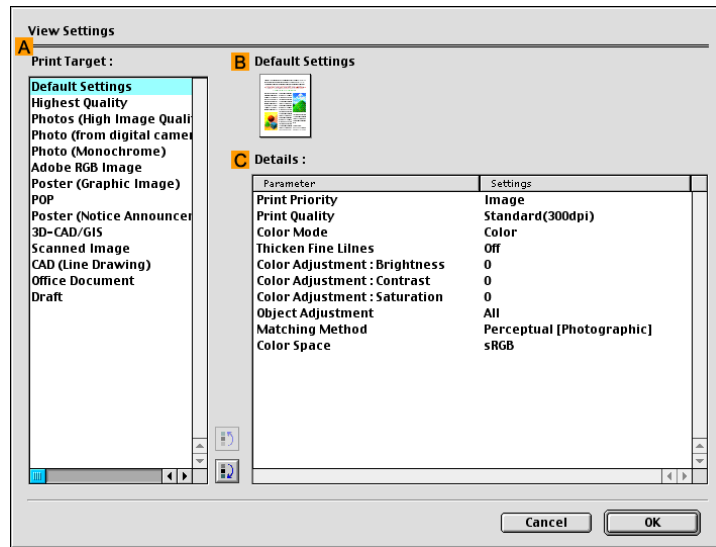

Note

- To display the **View Settings** dialog box, on the **Main Pane (Mac OS 9)** (→P.521), click **View Settings** by **Print Target**.

Setting Item	Description
A Print Target	Shows all Print Target options (settings items for the printing application).
B Name	Identifies the item selected in Print Target by its name and an icon.
C Details	Here, you can confirm detailed settings values for each item selected in the Print Target list.

Network Setting

Network Setting

Network Environment

System requirements

The system requirements, which vary depending on your network, are as follows.

- Printing over a TCP/IP network
 - Compatible operating systems
 - Windows 2000 (Professional or Server)
 - Windows XP (Home Edition or Professional)
 - Windows Server 2003 (Standard Edition)
 - Windows Vista (Home Basic/Business/Ultimate)
 - Mac OS 9.1 or later
 - Mac OS X 10.2.8 or later
 - Compatible computer
 - A computer that runs one of the above operating systems
- Printing over an AppleTalk network
 - Compatible operating systems
 - Mac OS 9.1 or later
 - Mac OS X 10.2.8 or later
 - Compatible computer
 - A computer that runs one of the above operating systems



Note

- The printer cannot be used over a LocalTalk network.
- Compatible with EtherTalk Phase 2.
- Printing over a NetWare network
 - Compatible servers
 - Novell NetWare 4.2/5.1/6.0
 - Compatible clients
 - Windows 2000 (Professional or Server)
 - Windows XP (Professional)
 - Compatible computer
 - A computer that runs one of the above operating systems



Note

- In NetWare 6.0, iPrint is not supported.

Network environment

After confirming what type of network environment you will connect the printer to, set up the printer and computers as needed.

- Example of a Windows network

In Windows networks, print over TCP/IP.

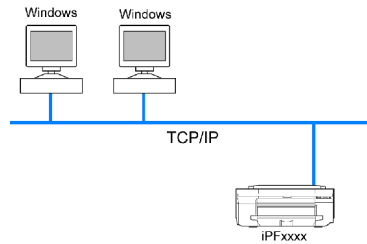

Note

- NetBIOS is not supported.

- Example of a Macintosh network

In Macintosh networks, print over AppleTalk (EtherTalk) or TCP/IP, using Bonjour(Zeroconf) functions.

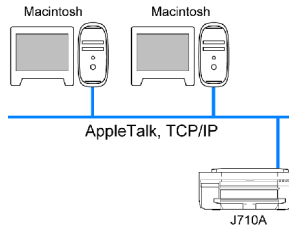

- Example of a NetWare network

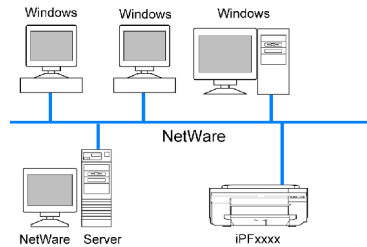

Note

- Even if there is a NetWare server in your network environment, you can use both TCP/IP and AppleTalk. In this case, complete the settings for each protocol you will use.

Configuring the IP Address on the Printer

You must configure the printer's IP address before using the printer on a TCP/IP network.

The printer's IP address is configured automatically when you install the printer driver following the instructions in the Quick Start Guide.

Follow the steps below to configure the IP address by using imagePROGRAF Device Setup Utility, the printer Control Panel, or ARP or PING commands, if the IP address is changed, or if you change the printer connection mode to a network connection. For details on configuring the IP address, refer to the following topics.

- Configuring the IP Address Using imagePROGRAF Device Setup Utility (Windows) (→P.471)
- Configuring the IP Address Using the Printer Control Panel (→P.551)
- Configuring the IP Address Using ARP and PING Commands (→P.552)



Note

- We recommend configuring the printer's IP address even if you will use the printer in other network except for TCP/IP. Configuring the printer's IP address enables you to use RemoteUI to configure the network settings and manage the printer with a web browser. For details on RemoteUI, see "Using RemoteUI". (→P.555)

Initializing the Network Settings

Use RemoteUI to restore the network settings to the default values as follows.



Important

- Initializing the network settings will also restore the default value of the printer's IP address. As a result, the RemoteUI page cannot be displayed in the web browser after this procedure.
- For instructions on reconfiguring the IP address, see “Configuring the IP Address on the Printer”. (→P.547)
- For details on RemoteUI, see “Using RemoteUI”. (→P.555)

1. Start the web browser and enter the following URL in the **Location** (or **Address**) box to display the RemoteUI page.

http://“printer IP address or name”/

Example: http://xxx.xxx.xxx.xxx/

2. Select **Administrator Mode** and click **Logon**.
3. If a password has been set on the printer, enter the password.
4. Click **Network** in the **Device Manager** menu at left to display the **Network** page.
5. Click **Reset to Default settings** in the lower-right corner of the **Network Interface** group.
6. After confirming the message, click **OK** to restore the network settings to the default values.



Note

- You can also use imagePROGRAF Device Setup Utility or the Control Panel to restore the default network settings.
- If you use the Control Panel to initialize the network settings, press the **Menu** button to display **MAIN MENU**, and then press **▲**, **▼**, and **▶** to select **Interface Setup** → **Ethernet Driver** → **Init. Settings** → **Yes** (in this order), and finally press the **OK** button.

Configuring the Printer's TCP/IP Network Settings

Follow the steps below to configure the TCP/IP network settings.

1. Start the web browser and enter the following URL in the **Location** (or **Address**) box to display the RemoteUI page.
http://“printer IP address or name”/
Example: http://xxx.xxx.xxx.xxx/
2. Select **Administrator Mode** and click **Logon**.
3. If a password has been set on the printer, enter the password.
4. Click **Network** in the **Device Manager** menu at left to display the **Network** page.
5. Click **Edit** in the upper-right corner of the **TCP/IP** group to display the **Edit TCP/IP Protocol Settings** page.
6. Refer to the TCP/IP Settings Items table to complete the settings.

TCP/IP Settings Items

Item	Details	Default Setting
Use DHCP	Activate this setting to use DHCP for configuring the IP address.	Off
Use BOOTP	Activate this setting to use BOOTP for configuring the IP address.	Off
Use RARP	Activate this setting to use RARP for configuring the IP address.	Off
RAW Mode Bi-direction	Activate this setting to use Raw mode bidirectional communication.	Off
Enable DNS Dynamic Update	Activate this setting to perform DNS server registration automatically.	Off
Use Zeroconf Function	Activate this setting to use Bonjour.	On
IP Address	Specify the printer's IP address.	0.0.0.0
Subnet Mask	Specify the printer's subnet mask.	0.0.0.0
Gateway Address	Specify the printer's default gateway.	0.0.0.0
LPD Printing	Activate this setting to use LDP Printing.	On
IPP Printing	Activate this setting to use IPP Printing.	On
IPP Printer URI	Specify the URI of the printer used for IPP printing using up to 252 characters (1-252 characters). When using a standard Windows port for IPP printing, enter an URL less than 255 bytes for all characters for “http://<IP address>/IPP-URI.”	printer

Item	Details	Default Setting
RAW Printing	Activate this setting to use Raw Printing.	On
SMTP Server Address	Specify the SMTP server's IP address.	0.0.0.0
Primary DNS Server Address	Specify the IP address of the primary DNS server.	0.0.0.0
Secondary DNS Server Address	Specify the IP address of the secondary DNS server.	0.0.0.0
DNS Host Name	Specify the printer host name, up to 63 characters (1-63 characters). Use single-byte letters, numbers, and "-" (hyphens). Do not use numbers or "-" for the first character or "-" for the last character.	NB-17FBxxxxxxxxxxxx
DNS Domain Name	Specify the printer domain name, up to 63 characters. Use single-byte letters, numbers, "-" (hyphens), and "." (periods). Do not use numbers, "-", or "." for the first character, or "-" or "." for the last character.	(Blank)
Multicast DNS Service Name	Specify the printer's Multicast DNS service name, up to 63 characters. (1-63 characters) This name will be displayed when Bonjour functions are used.	Canon iPFxxxx (xxxxxx)

7. Click **OK** to display the **Network** page.



Note

- If you specify to configure the IP address using DHCP, BOOTP, or RARP, there must be a server that supports such protocol running in the network.
- If you specify to configure the IP address using DHCP, BOOTP, or RARP, the IP address obtained by this method is used first. If you cannot obtain the IP address, the address specified in **IP Address** is used.
- It takes a minute or two to determine whether DHCP, BOOTP, or RARP are available. We recommend clearing check boxes of options you will not use.
- If you are using a DNS server, select **Enable DNS Dynamic Update** and enter the IP Address for DNS servers, DNS host name, and DNS domain name in **Primary DNS Server Address**, **Secondary DNS Server Address**, **DNS Host Name**, and **DNS Domain Name**, respectively.

Configuring the IP Address Using the Printer Control Panel

This topic describes how to configure the printer's IP address on the Control Panel.

1. Press the **Menu** button to display **MAIN MENU**.

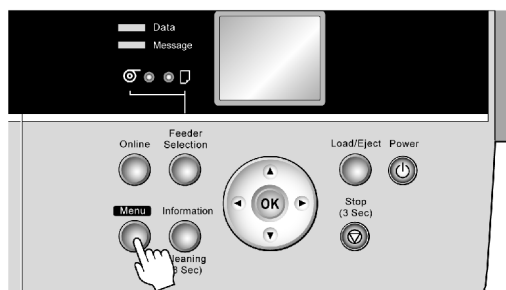

2. Press **▲** or **▼** to select **Interface Setup**, and then press the **▶** button.
3. Press **▲** or **▼** to select **TCP/IP**, and then press the **▶** button.
4. Press **▲** or **▼** to select **IP Setting**, and then press the **▶** button.
5. Press **▲** or **▼** to select **IP Address**, and then press the **▶** button.
6. After pressing **◀** or **▶** to select the input field, press the **OK** button to enable numerical input.
7. Press **▲** or **▼** to select the number, and then press the **OK** button.



Note

- Pressing the **▲** button increases the number by 1. The maximum value is "255," after which "0" is displayed.
- Pressing the **▼** button decreases the number by 1. The minimum value is "0," after which "255" is displayed.
- Hold down **▲** or **▼** to increase or decrease the value continuously.

8. Repeat steps 3-4 to enter the IP address assigned to the printer.

9. Press the **Online** button to bring the printer online.

If any of the settings are changed, a message for confirmation is displayed. In this case, press the **OK** button.

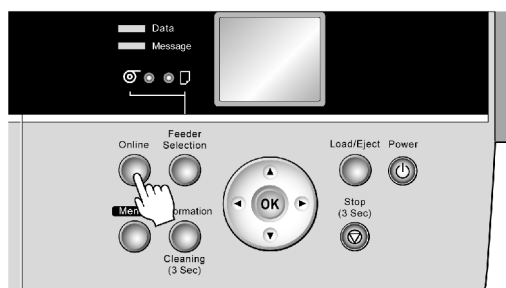

Note

- If an error message is displayed, check the settings and correct any invalid values.
- To cancel the setup process, hold down the **Stop** button for a second or more.



Important

- Be sure to complete step 6. This will activate the values you have entered.
- You can also specify the subnet mask and default gateway on the Control Panel.

Configuring the IP Address Using ARP and PING Commands

This topic describes how to configure the IP address using ARP and PING commands.

To use the ARP and PING commands, you will need to know the printer's MAC address. You can confirm the MAC address on the Control Panel.

1. Check the printer's MAC address.

You can confirm the MAC address on the Control Panel as follows:

1. Press the **Menu** button to display **MAIN MENU**.
2. Press **▲** or **▼** to select **Interface Setup**, and then press the **▶** button.
3. Press **▲** or **▼** to select **Ethernet Driver**, and then press the **▶** button.
4. Press **▲** or **▼** to select **MAC Address**, and then press the **▶** button.

You can also print information on the printer status, which includes the MAC address, as follows:

1. Press the **Menu** button to display **MAIN MENU**.
2. Press **▲** or **▼** to select **Test Print**, and then press the **▶** button.
3. Press **▲** or **▼** to select **Status Print**, and then press the **▶** button.
4. Press **▲** or **▼** to select **Yes**, and then press the **OK** button.

The MAC address is indicated in the printer status information in the following location.

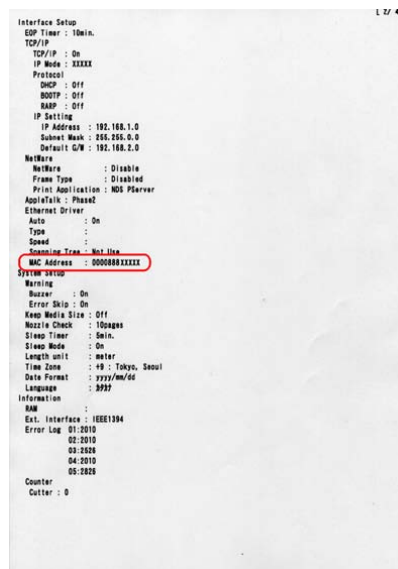

2. In Windows, open a command prompt or MS-DOS prompt, or in Mac OS X, start Terminal.
3. Execute the following command to add entries to the ARP table for managing IP addresses and corresponding MAC addresses.

`arp -s [IP address] [the printer's MAC address you have verified]`

Example: `arp -s xxx.xxx.xxx.xxx 00-00-85-xx-xx-xx`



Note

- In Mac OS X when using Terminal, enter the arp command in the format “arp -s xxx.xxx.xxx.xxx 00:00:85:xx:xx:xx.” For details, refer to the help file for the command line.

4. Execute the following command to send the IP address to the printer and configure it.
ping [IP address as specified in the ARP command] -l 479
Example: ping xxx.xxx.xxx.xxx -l 479

**Note**

- In “-l,” the “l” is the letter “l”.
- In Mac OS X when using Terminal, enter the ping command in the format “ping -s 479 xxx.xxx.xxx.xxx.” For details, refer to the help file for the command line.

**Note**

- The subnet mask and default gateway will be set to “0.0.0.0.” Use RemoteUI to change the subnet mask and default gateway to match your network settings.
For details on RemoteUI, see “Using RemoteUI”. (→P.555)

☐ Specifying Printer-Related Information

Follow the steps below to specify device information and security settings.

1. Start the web browser and enter the following URL in the **Location** (or **Address**) box to display the RemoteUI page.
 http://“printer IP address or name”/
 Example: http://xxx.xxx.xxx.xxx/
2. Select **Administrator Mode** and click **Logon**.
3. If a password has been set on the printer, enter the password.
4. Click **Information** in the **Device Manager** menu at left to display the **Information** page.
5. To display the relevant settings page, click **Edit** in the upper-right corner of **Device Information** or **Security**, depending on what information you want to specify.
6. Refer to the tables of settings items for device information and security settings to complete the settings.

Device information settings items

Item	Details	Default Setting
Device Name	Specify the device name. (0-32 characters)	(Blank)
Location	Specify where the device is installed. (0-32 characters)	(Blank)
Administrator	Identify the administrator. (0-32 characters)	(Blank)
Phone	Specify the device administrator's contact information. (0-32 characters)	(Blank)
Comments(E-mail)	Enter any notes from the device administrator. (0-32 characters)	(Blank)

Security settings items

Item	Details	Default Setting
Old Password	Enter the current device password. (0-15 characters)	(Blank)
New Password	Enter a new password. (0-15 characters)	(Blank)
Confirm	Enter the new password again to confirm it. (0-15 characters)	(Blank)

Besides entering a password, you can specify other security-related information, such as use of SNMP or IPP authentication, or an IP address to restrict printing via TCP/IP.

7. Click **OK** to activate the settings.

Using RemoteUI

Enter the printer's IP address in a web browser to display the RemoteUI page. After you log on to RemoteUI from the page, you can check and change the status of the printer and print jobs, and configure network settings.

For details on configuring printer settings for networks, refer to the following topics.

- Configuring the Printer's TCP/IP Network Settings (→P.549)
- Configuring the Printer's AppleTalk Network Settings (→P.572)
- Configuring the Printer's NetWare Network Settings (→P.557)
- Specifying Printer-Related Information (→P.554)



Note

- RemoteUI also offers many other features. You can display the ink levels, check error messages and other status information, and cancel print jobs.
- By factory default, the English screen is displayed. You can change the display language after logging on by choosing the desired language in the **Language** list.



Important

- Use Netscape Navigator/Communicator 6.0 or later, Internet Explorer 5.01 or later, or Firefox 1.5 or later as a web browser. In Mac OS X, you can also use Safari 1.32 or later or Safari 2.03 or later.
- Access is not possible via a proxy server. In environments where a proxy server is used, add the printer's IP address to **Exceptions** (addresses accessed without a proxy server) in the web browser proxy server settings. (Settings may vary depending on the network environment.)
- Enable JavaScript and cookies in the web browser.
- If you access RemoteUI with the printer name instead of its IP address, make sure the DNS settings are correctly configured.

☐ Email Notification When Printing is Finished or Errors Occur

The printer can notify you of the printer status by email. Even when you are away from the printer, you can know when printing is finished or if errors occur. Receive notification via email on your mobile phone or at your computer.

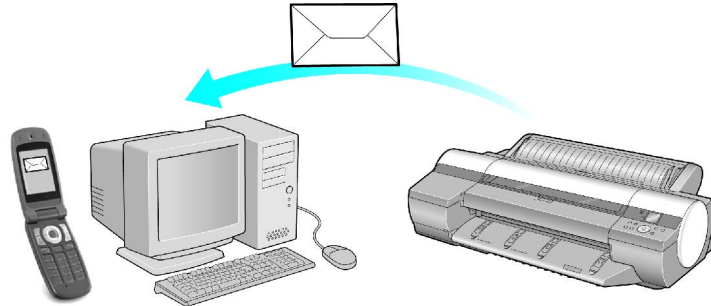

Use the imagePROGRAF Status Monitor (Windows) function to set up email recipients and message timing. Besides being informed of finished print jobs or errors, you can also complete settings for email notification when service is needed or it's time to replace consumables.



Note

- For details on email notification using imagePROGRAF Status Monitor (in Windows), refer to the imagePROGRAF Status Monitor help.

Network Setting (Windows)

Configuring the Printer's NetWare Network Settings

Follow the steps below to configure the NetWare network settings.

1. Start the web browser and enter the following URL in the **Location** (or **Address**) box to display the RemoteUI page.
http://“printer IP address or name”/
Example: http://xxx.xxx.xxx.xxx/
2. Select **Administrator Mode** and click **Logon**.
3. If a password has been set on the printer, enter the password.
4. Click **Network** in the **Device Manager** menu at left to display the **Network** page.
5. Click **Edit** in the upper-right corner of the **NetWare** group to display the **Edit NetWare Protocol Settings** page.
6. Refer to the NetWare Settings Items table to complete the settings.

NetWare Settings Items

Item		Details	Default Setting
Frame Type		Specify the type of frame to use in NetWare.	Disabled
NCP Burst Mode		Activate this setting to use NCP Burst Mode. This mode supports fast data transfer when printing in queue server mode. Normally, leave the setting On.	On
Print Application		Choose the print service. <ul style="list-style-type: none"> • Bindery PServer • RPrinter • NDS PServer • NPrinter 	NDS PServer
Packet Signature		Select If Requested by Server to use packet signature.	If Requested by Server
Bindery PServer	File Server Name	Specify the name of a file server that has a NetWare print server, up to 47 characters.	-
	Print Server Name	Specify the name of a NetWare print server, up to 47 characters.	-
	Print Server Password	Set a password for the print server, up to 20 characters.	-
	Polling Interval	Specify the interval to confirm jobs. (1-15 seconds)	5

Item		Details	Default Setting
RPrinter	Print Server Name	Specify the name of a NetWare print server, up to 47 characters.	-
	Printer Number	Specify the number of the printer connected to the NetWare print server. (0-5)	0
NDS PServer	Tree Name	Specify the name of an NDS tree that has a NetWare print server, up to 32 characters.	-
	Context Name	Specify the name of a context that has a NetWare print server, up to 255 characters.	-
	Print Server Name	Specify the name of a NetWare print server, up to 64 characters.	-
	Print Server Password	Set a password for the print server, up to 20 characters.	-
	Polling Interval	Specify the interval to confirm jobs. (1-255 seconds)	5
NPrinter	Print Server Name	Specify the name of a NetWare print server, up to 47 characters. Enter the advertising name of the print server designated by the NetWare print service. Usually, the advertising name is the same as the name of the print server.	-
	Printer Number	Specify the number of the printer connected to the NetWare print server. (0-254) Enter the printer number designated by the NetWare print service.	0

7. Click **OK** to display the **Network** page.

☰ Specifying the Printer's Frame Type

To enable communication between the printer and computers on your network, specify the Ethernet frame type in your NetWare environment.

Follow the steps below to specify the frame type by using imagePROGRAF Device Setup Utility or the printer Control Panel.



Note

- You can specify the frame type by using RemoteUI if the printer's IP address is configured.



Important

- Before specifying the frame type, make sure the printer is on and connected to the network.
- For instructions on installing imagePROGRAF Device Setup Utility, see "Installing imagePROGRAF Device Setup Utility". (→P.470)

Specifying the frame type using imagePROGRAF Device Setup Utility

1. Start imagePROGRAF Device Setup Utility.
2. In the list of printers, select the printer to configure.
3. Choose **Protocol Settings** from the **Printer** menu.
4. In the **NetWare Frame Type** list, select the frame type.
5. Make sure **ETHERNET II** is selected under **Frame Type** in **TCP/IP**.
6. In **IP Address**, enter the IP address assigned to the printer, and then enter the subnet mask in **Subnet Mask** and the default gateway in **Gateway Address**.



Important

- You must specify the IP address here to be able to configure NetWare protocol settings using RemoteUI.

7. Click **Set**.
8. Click **OK** after the **Confirmation** message dialog box is displayed.
9. Exit imagePROGRAF Device Setup Utility.

Specifying the frame type using the printer Control Panel

1. Press the **Menu** button to display **MAIN MENU**.

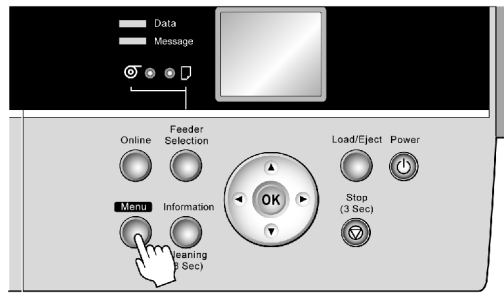

2. Press **▲** or **▼** to select **Interface Setup**, and then press the **▶** button.
3. Press **▲** or **▼** to select **NetWare**, and then press the **▶** button.
4. Press **▲** or **▼** to select **NetWare**, and then press the **▶** button.
5. Press **▲** or **▼** to select **On**, and then press the **OK** button.
Return to the **NetWare** menu.
6. Press **▲** or **▼** to select **Frame Type**, and then press the **▶** button.
7. Press **▲** or **▼** to select the frame type to use, and then press the **OK** button.
Return to the **NetWare** menu.
8. Press **▲** or **▼** to select **Print Service**, and then press the **▶** button.
9. Press **▲** or **▼** to select the desired print service, and then press the **OK** button.
Return to the **NetWare** menu.
10. Press the **Online** button to bring the printer online.
If any of the settings is changed, a message for confirmation is displayed. In this case, press the **OK** button.

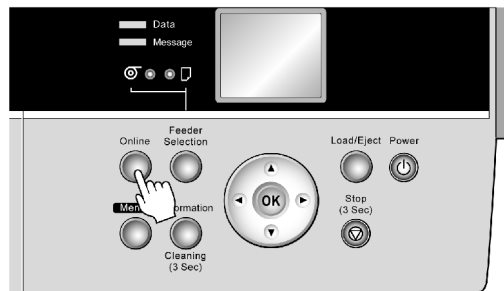

Note

- If an error message is displayed, check the settings and correct any invalid values.
- To cancel the setup process, hold down the **Stop** button for a second or more.



Important

- Be sure to complete step 5. This will activate the values you have entered.

Specifying NetWare Print Services

Before printing in a NetWare network, you must configure print services such as print servers, print queues, and so on. You can configure the print service settings from a computer using any of the following software.

- NWADMIN
- PCONSOLE
(from Novell, provided with NetWare)



Important

- If you use NWADMIN to configure the print service settings, Novell Client (the Novell NetWare client software) must be installed as the client software application.
- NetWare networking is unsupported in Windows Vista.

This topic gives instructions for configuring NetWare print services. The order of this procedure may vary depending on the environment.

Choosing the type of print services

Before completing print service settings, choose the type of print service. Refer to the following descriptions as needed.



Note

- In NetWare 5.1/6.0/6.5, NDPS may also be used as the print service. If you use NDPS, use the Novell printer gateway included with NetWare. For details on configuring NDPS, refer to the NetWare documentation.
- NDS (Novell Directory Service) and Bindery
NDS and bindery are both supported. Use the mode that is compatible with your network environment.
- Queue Server Mode and Remote Printer Mode
Queue server mode and remote printer mode are both supported.
 - Queue Server Mode
When using queue server mode, all print server functions are supported, so there is no need for other print server software or hardware. In NDS queue server mode (NDS PServer), the NDS print server is used for printing. In bindery queue server mode (Bindery PServer), the bindery print server is used for printing. Note that if you use queue server mode, a NetWare user license is required for each network interface.
 - Remote Printer Mode
In remote printer mode, the printer is controlled by the NetWare print server. Thus, a NetWare print server is required. In NDS remote printer mode (NPrinter), the NDS print server is used for printing, and in bindery remote printer mode (RPrinter), the bindery print server is used for printing.

Using NWADMIN or PCONSOLE to set up the print server

Use NWADMIN to set up the print server if NDS queue server mode or remote printer mode is used.

1. Log into NetWare as Administrator or with equivalent rights, and then start NWADMIN.
2. Run Quick Setup.
 1. Choose **Print Services Quick Setup** in the **Tools** menu.
 2. Enter a desired name in **Print Server Name**. To use an existing print server, click the button at right and choose the name from the list.
 3. Enter a desired printer name in **Name**.
 4. To use the printer in queue server mode, choose **Other/Unknown** in **Type**. To use the printer in remote printer mode, choose **Parallel** in **Type**, click **Communications**, and set **Ports** to **LPT1** and **Connection Type** to **Manual Load**.
 5. Enter a desired queue name in **Name**.
 6. In **Volume**, enter the volume object (that is, the object representing the physical volume on the network) where the print queue will be created. Click the button at right to choose from a list.
 7. Complete other settings as needed and click **OK**.



Note

- The print server name will be required when configuring the printer's network settings. Note the print server name for future reference.
- When running Quick Setup, the printer is assigned printer number "0." When using the printer in queue server mode, do not change the printer number from "0."

3. Set a password.
 1. Right-click the print server created in step 2 and choose **Details**.
 2. Click **Change Password** to open the password input dialog box. Enter the password.
 3. Click **OK** to close the password input dialog box.
 4. Click **OK** or **Cancel** to close the details dialog box.
4. To use the printer in remote printer mode, start the print server.

To use the NetWare file server as the print server, enter "LOAD PSERVER.NLM" at the file server and press the Enter key.



Note

- This procedure is not required when using queue server mode.

Use PCONSOLE to set up the print server if bindery queue server mode or remote printer mode is used.

1. Log into NetWare as Supervisor and start PCONSOLE.
2. Switch to bindery mode.
3. If the print server has not been created, create it.
 1. In **Available Options**, select **Quick Setup** and press the Enter key.
 2. Enter the name of the new print server, the new printer, and the queue.



Note

- The print server name will be required when configuring the printer's protocol settings. Note down the print server name for future reference.

4. Specify the printer type.
 1. To use the printer in queue server mode, choose **Other/Unknown** in **Type**. To use remote printer mode, set **Printer Type** to **Parallel** and **Position** to **Manual Load**.
 2. Press the Esc key.
 3. After the confirmation message is displayed, choose **Yes** and press the Enter key.
5. Set a password.
 1. In **Available Options**, select **Print Servers** and press the Enter key.
 2. Select the print server created in step 2 and press the Enter key.
 3. Select **Password**, and press the Enter key to display the password input dialog box.
 4. Enter the password and press the Enter key.
6. Press the Esc key several times to display the dialog box for confirming that PCONSOLE is finished.
7. Click **Yes** to exit PCONSOLE.

☐ Specifying NetWare Protocols

Follow the steps below to configure NetWare protocol settings other than the frame type by using RemoteUI.



Note

- For details on RemoteUI, see “Using RemoteUI”. (→P.555)

1. Start the web browser and enter the following URL in the **Location** (or **Address**) box to display the RemoteUI page.

http://“printer IP address or name”/

Example: http://xxx.xxx.xxx.xxx/

2. Select **Administrator Mode** and click **Logon**.
3. If a password has been set on the printer, enter the password.
4. Click **Network** in the **Device Manager** menu at left to display the **Network** page.
5. Click **Edit** in the upper-right corner of the **NetWare** group to display the **Edit NetWare Protocol Settings** page.
6. Make sure the **Frame Type** indicates the frame type used on the NetWare network.
7. To use burst mode, choose **On** for **NCP Burst Mode**.



Note

- Burst mode supports fast data transfer when printing in queue server mode. Normally, choose **On**.

8. In **Print Application**, click the print service to be used.



Note

- Only one print service selected here will be enabled. Multiple print services are not available at the same time.

9. For packet signature, click **If Requested by Server** in **Packet Signature**.
10. Complete the following settings based on the selected service.
 - If you have selected Bindery PServer: Queue Server Mode (Using a Bindery Print Server)
 1. In **File Server Name**, enter the file server name.
 2. In **Print Server Name**, enter the name of the print server created in Specifying NetWare Print Services. (→P.561)
 3. In **Print Server Password**, enter the password of the print server created in Specifying NetWare Print Services. (→P.561)
 4. In **Polling Interval**, specify the interval at which the printer checks the NetWare print queue.
 - If you have selected RPrinter: Remote Printer Mode (Using a Bindery Print Server)
 1. In **Print Server Name**, enter the advertising name of the print server created in Specifying NetWare Print Services. (→P.561)
 2. In **Printer Number**, enter the same printer number specified in Specifying NetWare Print Services. (→P.561)

- If you have selected NDS PServer: Queue Server Mode (Using an NDS Print Server)
 1. In **Tree Name** and **Context Name**, enter the tree and context name of the print server. Do not exceed 255 characters for the context name.
 2. In **Print Server Name**, enter the name of the print server created in Specifying NetWare Print Services. (→P.561)
 3. In **Print Server Password**, enter the password of the print server created in Specifying NetWare Print Services. (→P.561)
 4. In **Polling Interval**, specify the interval at which the printer checks the NetWare print queue.
- If you have selected NPrinter: Remote Printer Mode (Using a NDS Print Server)
 1. In **Print Server Name**, enter the advertising name of the print server created in Specifying NetWare Print Services. (→P.561) Usually, the advertising name is the same as the name of the print server.
 2. In **Printer Number**, enter the same printer number specified in Specifying NetWare Print Services. (→P.561)

11. Click **OK** to display the **Network** page.

12. Click **Reset** to activate the settings.

For a list of NetWare protocol settings items, see “Configuring the Printer’s NetWare Network Settings”. (→P.557)



Note

- If you use RemoteUI to display the print log in RPrinter or NPrinter mode, the document and user information cannot be obtained. Thus, **Document Name** only indicates **Unknown**, and the **User Name** information is identified as **RPRINTER/NPRINTER**.

Configuring NetWare Network Settings

To print over a NetWare network, configure the network environment as follows.



Important

- To configure network settings, you must be logged in with administrative rights such as “Administrator” account. We recommend that your network administrator configure the network settings.

- 1.** Specify the Ethernet frame type for communication between the printer and computers.
For instructions, see “Specifying the Printer’s Frame Type”. (→P.559)
- 2.** Specify the NetWare print services, including the print server and queue.
For instructions, see “Specifying NetWare Print Services”. (→P.561)
- 3.** Specify NetWare protocol details besides the frame type.
For instructions, see “Specifying NetWare Protocols”. (→P.564)
After you have completed the steps above, configure each computer for printing over the NetWare network.
- 4.** Connect to the NetWare network.
Install NetWare client software on each computer to be used for printing over the network, and log in to the NetWare server or tree. For instructions on connection, refer to the NetWare and operating system documentation.
- 5.** Install the printer driver.
Follow the instructions of your network administrator to install the printer driver on each computer to be used for printing. When installing the printer driver, choose **Network Printer** as the printer destination, and then choose the print queue created from the NetWare print service settings.
- 6.** Follow these steps to configure the printer port.
 - 1.** Open the **Printers and Faxes** (or **Printers**) window.
 - 2.** Right-click the printer icon and choose **Properties**.
 - 3.** Click the **Port** (or **Advanced**) tab to display the **Port** (or **Advanced**) sheet.
 - 4.** As the destination port, specify the print queue created by configuring the NetWare print service settings.



Note

- This step is not necessary if you specified the printer destination during installation of the printer driver.

Configuring the Printer Driver Destination (Windows)

This topic describes how to specify the printer driver destination if the printer's IP address is changed, or if you will use the printer over a network connection instead of via USB connection.



Important

- If you use the printer on a TCP/IP network, make sure the printer's IP address is configured correctly.
 - Configuring the IP Address on the Printer (→P.547)

1. Open the **Printers and Faxes** (or **Printers**) window.
2. Right-click the icon of this printer and choose **Properties** to open the printer properties window.
3. Click the **Port** tab to display the **Port** sheet.
4. Click **Add Port** to display the **Printer Ports** dialog box.
5. In the **Available Port** list, select **Standard TCP/IP Port**.
6. Click **New Port**.
After the wizard starts, a window is displayed for the **Welcome to the Add Standard TCP/IP Printer Port Wizard**.
7. Click **Next**.
8. In **Printer Name or IP Address**, enter the printer's IP address.
9. Follow the instructions on the screen to add a printer port.
10. Click **Close** to close the **Printer Ports** dialog box.
11. Make sure the printer port you added is displayed under **Ports**, and that the port is selected.
12. Click **OK** to close the printer properties window.



Note

- The procedure described above is the configuration based on the LPR or RAW protocol using the standard TCP/IP port in Windows (**Standard TCP/IP Port**).

Sharing the Printer in Windows

If you set up a computer as a print server in Windows 2000, Windows XP, or Windows Server 2003, the computer can receive print jobs sent from other computers (clients) connected to it for printing. This topic describes how to share the printer in Windows.



Important

- We recommend that your network administrator configure your network for printer sharing.

1. Open the **Printers and Faxes** (or **Printers**) window.

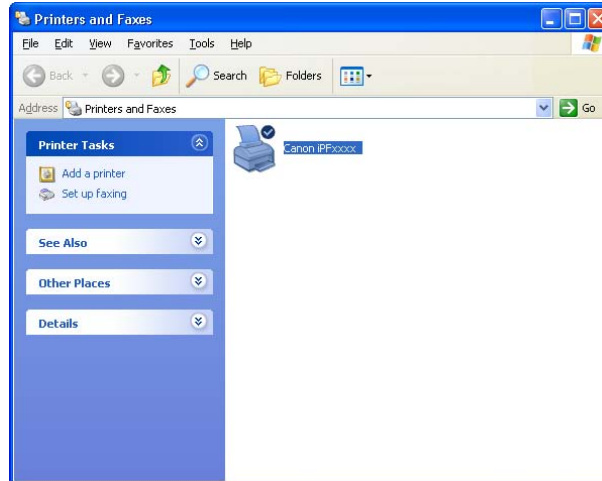

2. Right-click the icon of this printer and choose **Sharing** to open the printer properties window.

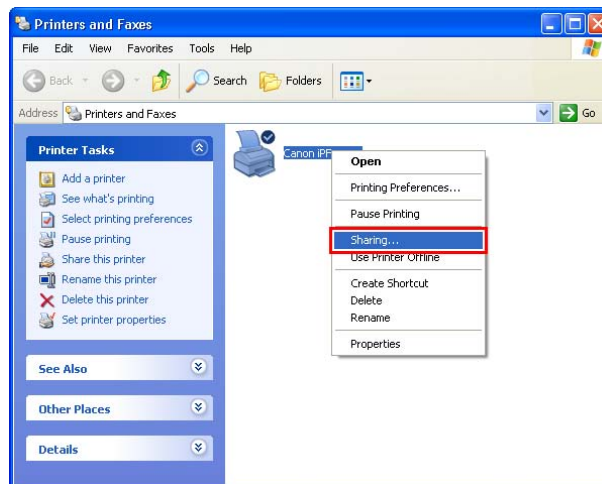

3. On the **Sharing** sheet, click **Share this printer** and enter the shared name.

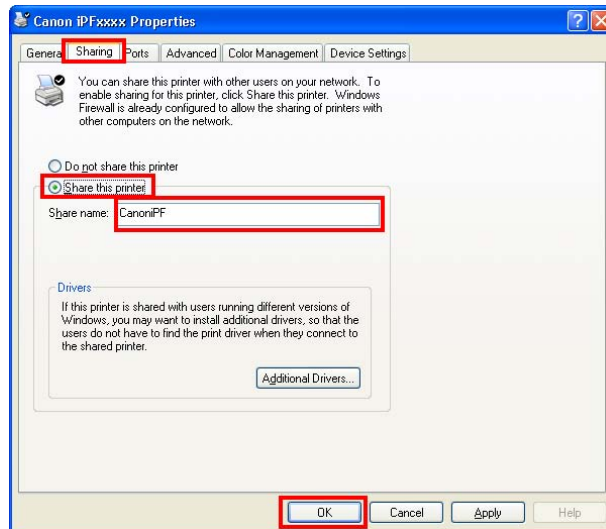

4. To print jobs from clients running other versions of Windows, click **Additional Drivers** and follow the instructions to install the printer driver of the corresponding version.

If you are prompted to choose the location of the printer driver file, insert the provided User Software CD-ROM in the CD-ROM drive and specify the folder where the printer driver is located.

5. Click **OK**.



Important

- When installing the printer driver on client computers, select "Network Printer" on the connection type screen in the printer wizard, and then select the printer shared from the computer set up as the print server.

Installing imagePROGRAF Device Setup Utility

Install imagePROGRAF Device Setup Utility from the User Software CD-ROM provided with the printer as follows:



Important

- In Windows 2000/Windows XP/Windows Server 2003/Windows Vista, you must log on with administrative rights equivalent to the “Administrator” account.

1. Insert the User Software CD-ROM in the CD-ROM drive.
2. On the **Setup Menu** window, click **Install Individual Software**.
3. Click **Install** in imagePROGRAF Device Setup Utility.
4. Follow the instructions on the screen to proceed with the installation.

Configuring the IP Address Using imagePROGRAF Device Setup Utility

From a computer running Windows, you can use imagePROGRAF Device Setup Utility provided with the printer to configure the printer's IP address. This topic describes how to configure the IP address using imagePROGRAF Device Setup Utility.



Important

- To configure network settings, you must be logged in with administrative rights such as “Administrator” account. We recommend that your network administrator configure the network settings.
- For instructions on installing imagePROGRAF Device Setup Utility, see “Installing imagePROGRAF Device Setup Utility”. (→P.470)

1. Start imagePROGRAF Device Setup Utility from the **start** menu.
2. In the list of printers, select the printer to configure.
3. Choose **Protocol Settings** from the **Printer** menu.
4. In the **Setting IP Address** list, choose **Manual**.
5. Enter the IP address assigned to the printer and click the **Set** button.
6. Click **OK** after the **Confirmation** message dialog box is displayed.
7. Exit imagePROGRAF Device Setup Utility.



Note

- To configure the IP address automatically, choose **Auto** in the **Setting IP Address** list and select **DHCP**, **BOOTP**, or **RARP**.
- You can also specify the subnet mask and default gateway.

Network Setting (Macintosh)

☐ Configuring the Printer's AppleTalk Network Settings

Follow the steps below to configure the AppleTalk network settings.

1. Start the web browser and enter the following URL in the **Location** (or **Address**) box to display the RemoteUI page.
http://“printer IP address or name”/
Example: http://xxx.xxx.xxx.xxx/
2. Select **Administrator Mode** and click **Logon**.
3. If a password has been set on the printer, enter the password.
4. Click **Network** in the **Device Manager** menu at left to display the **Network** page.
5. Click **Edit** in the upper-right corner of the **AppleTalk** group to display the **Edit AppleTalk Protocol Settings** page.
6. Refer to the AppleTalk Settings Items table to complete the settings.

AppleTalk Settings Items

Item	Details	Default Setting
Phase Type	Specify whether to use AppleTalk. If you will use AppleTalk, choose Phase 2 . If you will not use AppleTalk, choose Disabled .	Disabled
Name (*1)	Specify the object name used by AppleTalk (in up to 31 single-byte or 15 double-byte characters). However, do not use the following single-byte characters: @ * : =	Canon NB-17FB (xxxxxx)
Zone (*2)	Specify the printer zone name, up to 31 single-byte characters. However, do not use the following single-byte characters: @ : = Also avoid using “*” (which represents the default zone) in the middle of a string.	*

*1: The object name you have specified in **Name** is displayed in **Chooser** in Mac OS 9 or **Printer Setup Utility** (or **Print Center**) in Mac OS X. If you use multiple printers in the same zone, assign a unique name to each printer. By default, the network interface name is “Canon NB-17FB (xxxxxx).” (Here, xxxxxx is the last six digits of the printer's MAC address.)

2: If zones have been created on the network, enter the name of the printer's zone. If there are no zones, leave the asterisk “” entry (for the default zone) as it is. If you enter a network zone name that does not match created zones, the printer will not be detected by Macintosh computers. Consult your network administrator for information on zone names.

7. Click **OK** to display the **Network** page.

Configuring the Printer Driver Destination (Macintosh)

Specify the printer driver destination as follows if the printer's IP address is changed, or if you will use the printer over a network connection instead of via USB connection.

- If you switch to printing in an AppleTalk network, see “Configuring the Destination for AppleTalk Network (Macintosh)”. (→P.574)
- If you switch to printing in a TCP/IP network, or if the printer's IP address is changed, see “Configuring the Destination for TCP/IP Network (Macintosh)”. (→P.578)
- If you switch to printing in a Bonjour network, see “Configuring the Destination for Bonjour Network (Macintosh)”. (→P.582)

Configuring the Destination for AppleTalk Network (Macintosh)

To print over an AppleTalk network, activate the AppleTalk protocol and configure the destination as follows.

Activating AppleTalk on the printer



Important

- By factory default, the AppleTalk protocol is disabled on the printer.

1. Press the **Menu** button to display **MAIN MENU**.

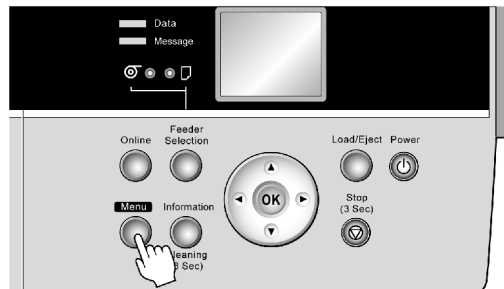

2. Press ▲ or ▼ to select **Interface Setup**, and then press the ► button.
3. Press ▲ or ▼ to select **AppleTalk**, and then press the ► button.
4. Press ▲ or ▼ to select **On**, and then press the **OK** button.
5. Press the **Online** button to bring the printer online.

If any of the settings is changed, a message for confirmation is displayed. In this case, press the **OK** button.

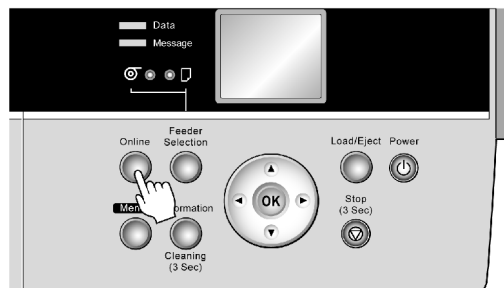

Note

- By using RemoteUI, you can also specify the object name used by AppleTalk, as well as the printer zone name.
For details on RemoteUI, see “Using RemoteUI”. (→P.555)



Important

- Be sure to complete step 3. This will activate the values you have entered.

Configuring the Destination (Mac OS 9)

1. Choose **Chooser** from the Apple menu to display the **Chooser** window.
2. In **AppleTalk**, click **Active**.

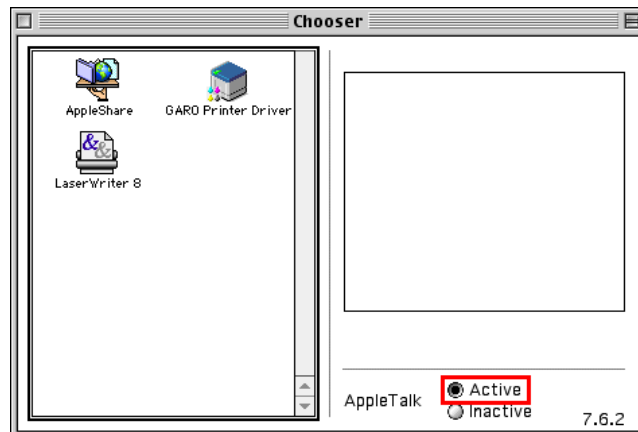

3. Close the **Chooser** window.
4. Click **AppleTalk** under **Control Panels** to display the **AppleTalk** window.
5. In **Connect via**, choose **Built-in Ethernet**.

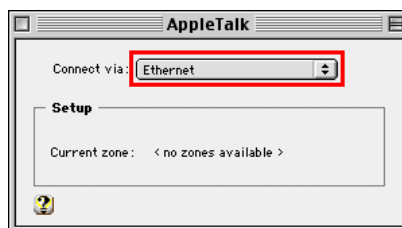

6. Close the **AppleTalk** window and save the settings.
7. Choose **Chooser** from the Apple menu to display the **Chooser** window.
8. In the list at left, click **GARO Printer Driver**.
9. In the **Destination** list at right, select **AppleTalk**, and then select the printer in the list below.

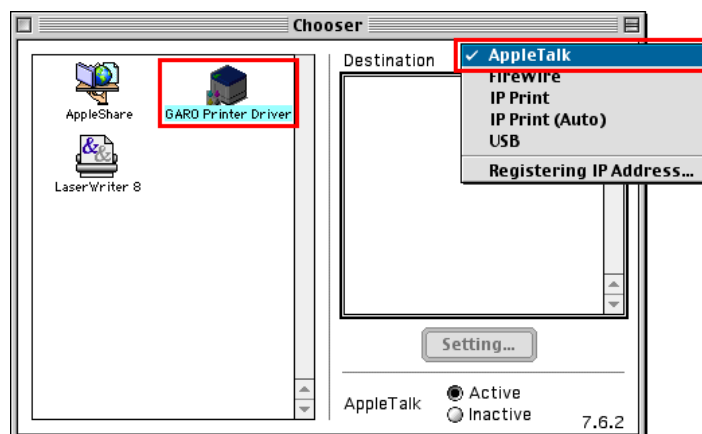

10. Close the **Chooser** window and click **OK** after the confirmation message is displayed.

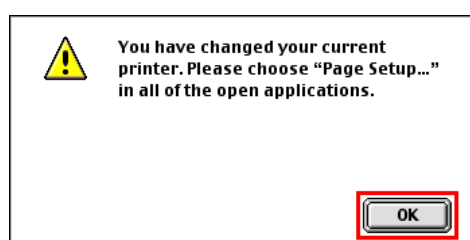

Configuring the Destination (Mac OS X)



Note

- The following procedures are based on Mac OS X 10.4. The method of configuring the destination varies depending on the version of Mac OS X.

1. In **System Preferences**, click **Network** to display the **Network** window.
2. In **Show**, choose **Built-in Ethernet**. Next, click **AppleTalk**, select **Make AppleTalk Active**, and click **Apply now**.

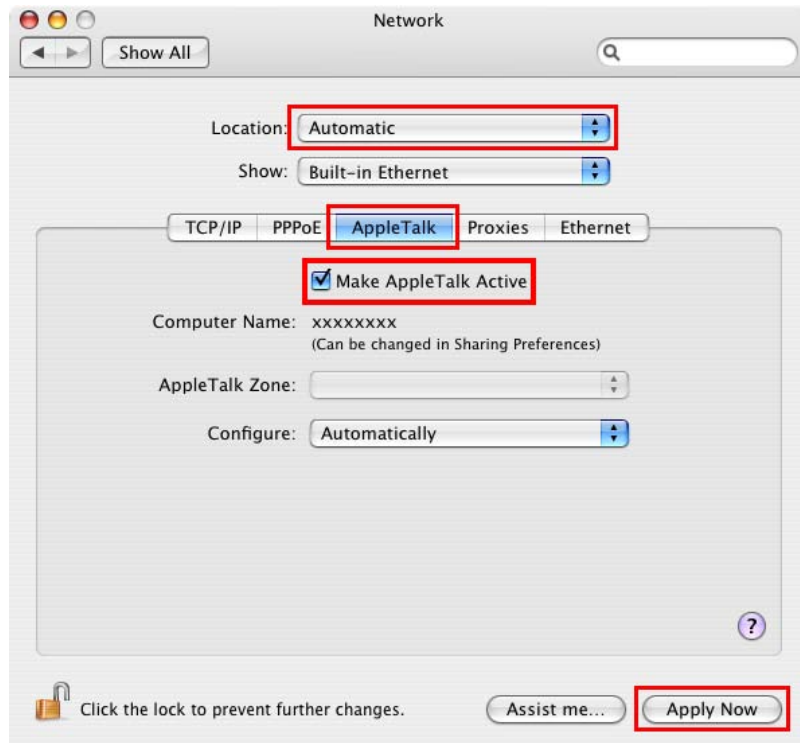

3. Close the **Network** window and save the settings.
4. Choose **Utilities** (or **Applications**) in the **Go** menu of **Finder**.
5. Click **Printer Setup Utility** (or **Print Center**) in the **Utilities** folder.
6. If the printer name is not displayed in **Printer List**, click **Add**.



7. Select the printer from the list in the **Printer Browser** window and click **Add**.

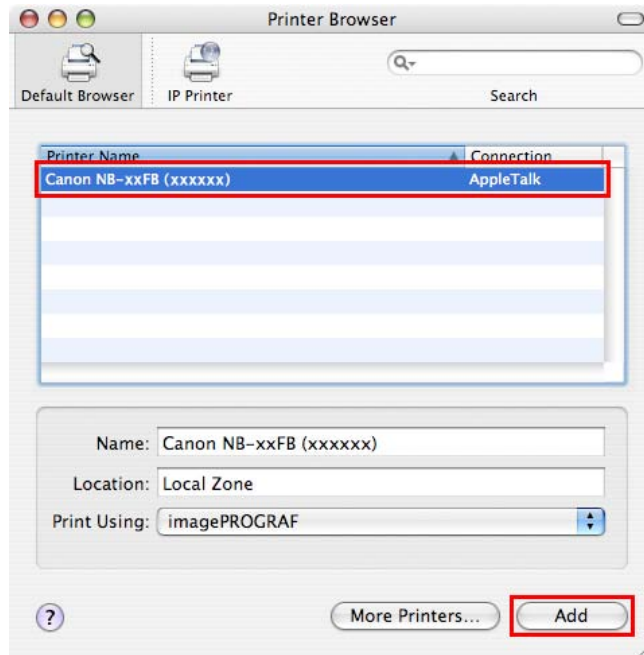

Configuring the Destination for TCP/IP Network (Macintosh)

Follow the steps below to configure the destination if you use the printer on TCP/IP network.



Important

- If you use the printer on TCP/IP network, make sure the printer's IP address is configured correctly.
 - Configuring the IP Address Using the Printer Control Panel (→P.551)

Configuring the Destination (Mac OS 9)

1. Choose **Chooser** from the Apple menu to display the **Chooser** window.
2. In the list at left, click **GARO Printer Driver**.

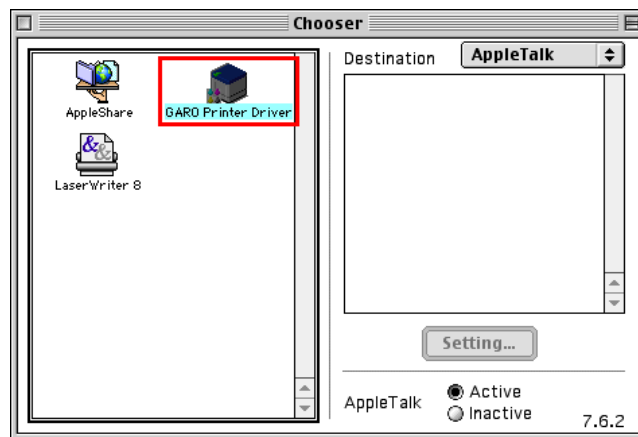

3. Click **Registering IP Address** in the **Destination** list to display the **IP Address Register/Edit** dialog box.

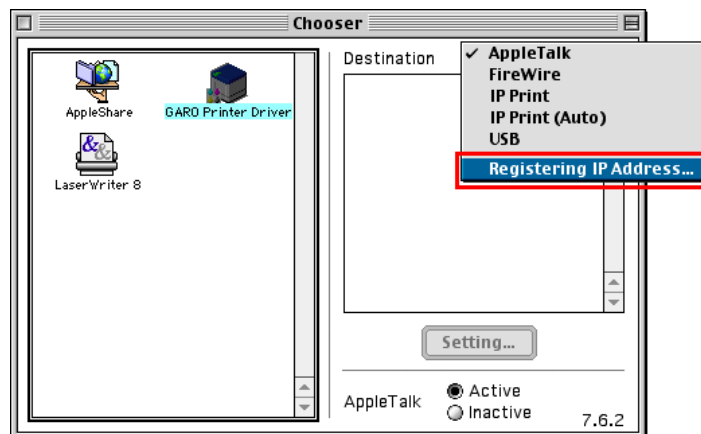

4. Enter the printer's IP address in **IP Address** and click **Add**.



5. Click **OK** to close the IP Address Register/Edit dialog box.

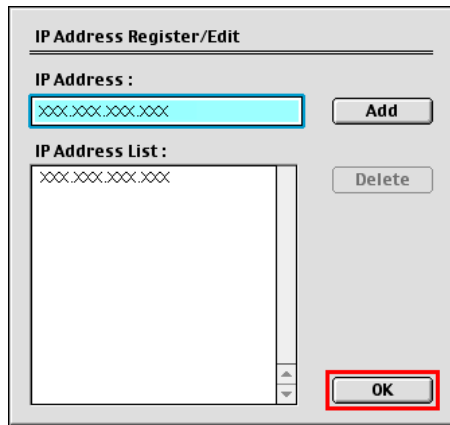

6. In the **Destination** list, click the address you registered.

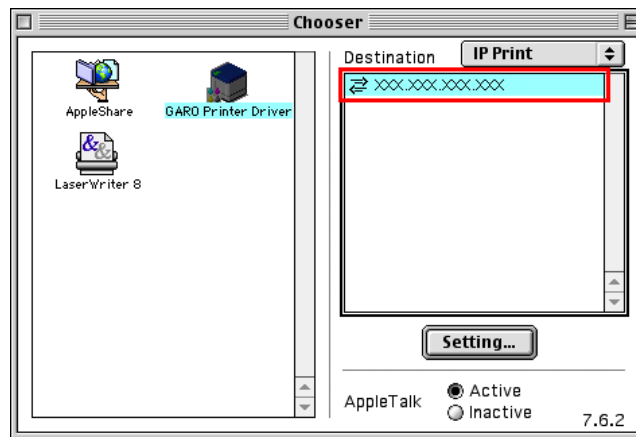

7. Close the **Chooser** window and click **OK** after the confirmation message is displayed.

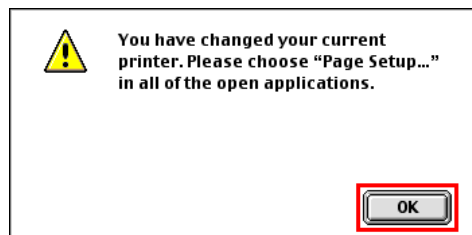

Configuring the Destination (Mac OS X)



Note

- The following procedures are based on Mac OS X 10.4. The method of configuring the destination varies depending on the version of Mac OS X. If you use other versions, refer to the help for the **Printer Setup Utility** (or the **Print Center**).

1. Choose **Utilities** (or **Applications**) in the **Go** menu of **Finder**.
2. Click **Printer Setup Utility** (or **Print Center**) in the **Utilities** folder.
3. Click **Add** to display the **Printer Browser** window.

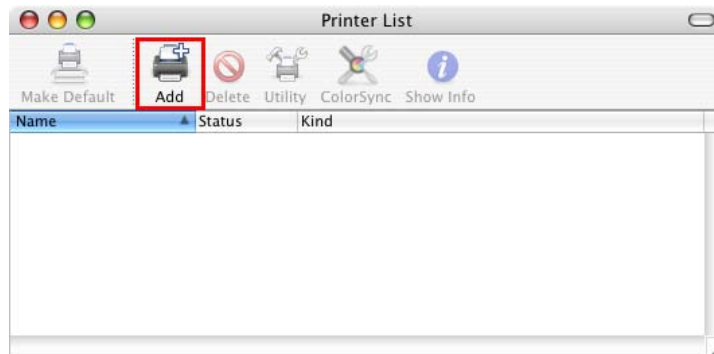

4. Click **More Printers**.

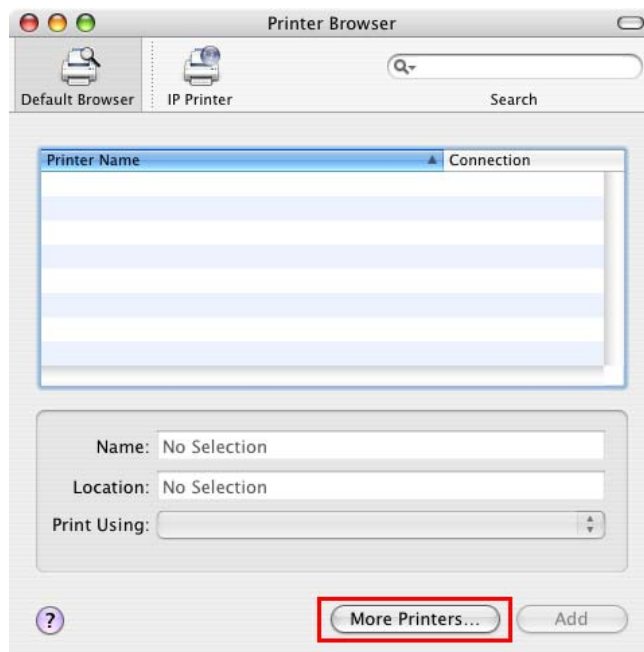

5. In the list of connection methods, click **Canon IP(iPF)**.

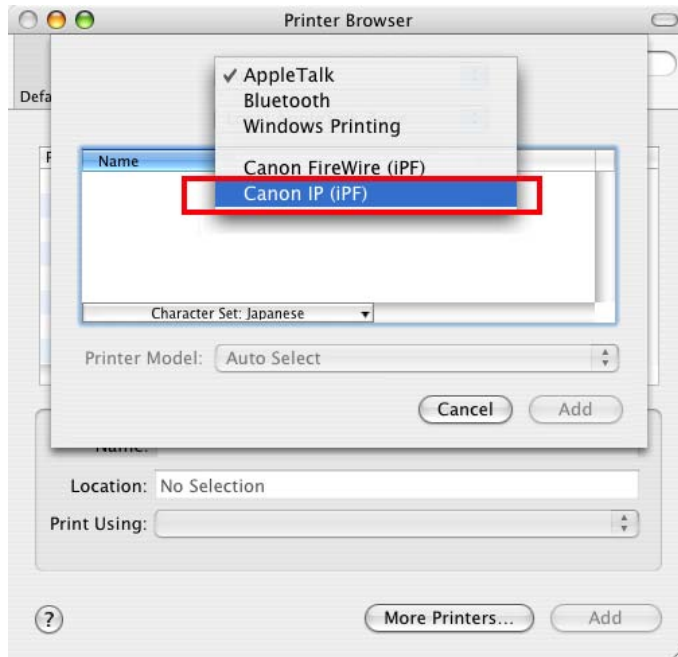

6. Enter the printer's IP address in **Printer's Address** and click **Add**.

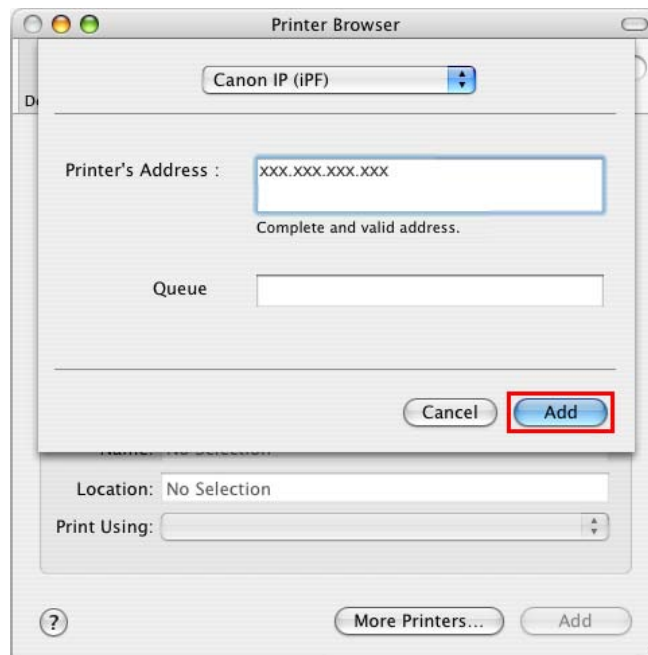

7. Make sure the printer has been added, and then close the **Printer List** window.

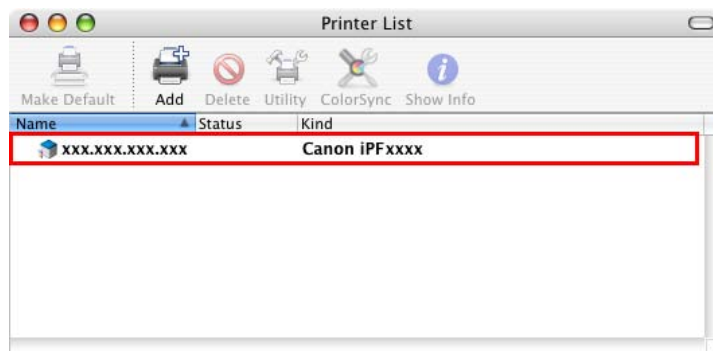

Configuring the Destination for Bonjour Network (Macintosh)

In Mac OS X 10.2.8 and later, use Bonjour functions to easily connect the printer to the network. Follow the steps below to configure the destination if you use the printer on TCP/IP network.



Note

- In Mac OS 9, if the computer's TCP/IP settings have been configured, you can connect the printer to the network as easily as with the Bonjour function.
Select **IP Print (Auto)** from the **Destination** list in **Chooser** to specify the destination.



Important

- Bonjour and **IP Print (Auto)** do not support printing to a printer on other network groups that require a router for connection. Make sure the computer and printer are on the same network. For information about network settings, ask your network administrator.
- By default, Bonjour is activated on the printer. The printer name as displayed in **Chooser** in Mac OS 9 or **Printer Setup Utility** (or **Print Center**) in Mac OS X is predefined as the **Multicast DNS Service Name**. You can activate or deactivate the Bonjour function or change the printer name by using RemoteUI. For instructions on changing it, see "Using RemoteUI". (→P.555)

1. Choose **Utilities** (or **Applications**) in the **Go** menu of **Finder**.
2. Click **Printer Setup Utility** (or **Print Center**) in the **Utilities** folder.
3. If the printer name is not displayed in **Printer List**, click **Add**.

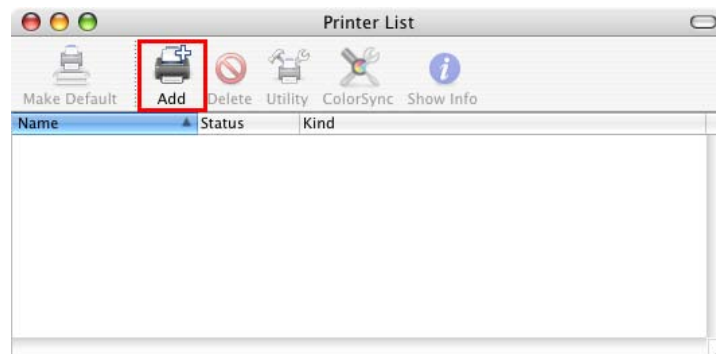

4. Select the printer from the list in the **Printer Browser** window and click **Add**.

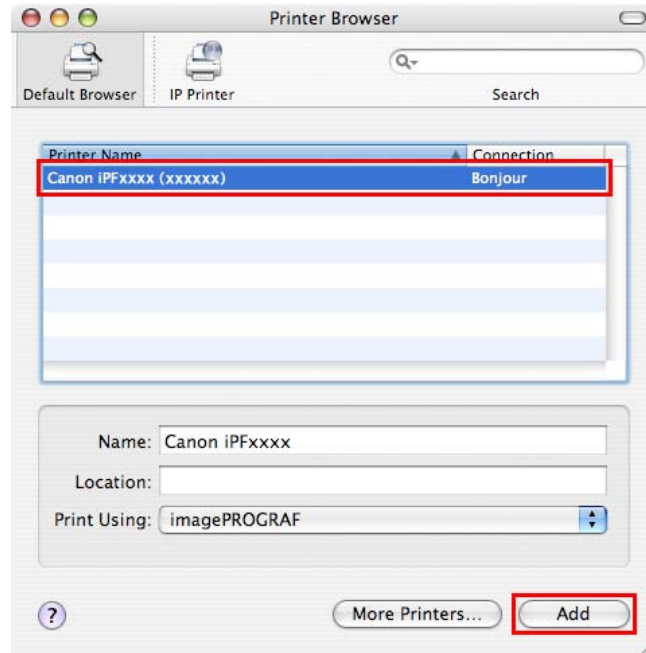

Maintenance

Adjusting the Printhead

Correcting Print Misalignment

If printed vertical lines are warped or colors are out of alignment, adjust the Printhead alignment. Adjust the Printhead alignment automatically or manually by using a printed test pattern.

For instructions on automatic adjustment, see “Adjusting the Printhead Alignment Automatically”. (→P.584)

For instructions on manual adjustment, see “Adjusting the Printhead Alignment Manually”. (→P.586)

Adjusting the Printhead Alignment Automatically

If printed vertical lines are warped or colors are out of alignment, adjust the Printhead alignment. Adjust the Printhead alignment automatically or manually by printing and reading a test pattern.

There are two modes for automatic adjustment: **Standard Adj.** and **Advanced Adj.** **Standard Adj.** will fix most slight image distortion or color misalignment, but if not, try **Advanced Adj.**

If using special media or printing does not improve even after performing automatic adjustment using advanced adjustment, try manual adjustment. For instructions on manual adjustment, see “Adjusting the Printhead Alignment Manually”. (→P.586)

Follow these steps for standard automatic adjustment of the Printhead.

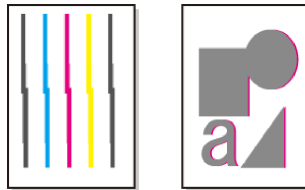

1. When using sheets, have two unused sheets A4/Letter-sized or larger ready when **Standard Adj.** is selected or 8 when **Advanced Adj.** is selected.

When using a roll, load a roll 10 inches (254 mm) or wider.

- Loading Sheets Manually (→P.156)
- Loading Rolls on the Roll Paper Holder (→P.116)
- Loading Rolls in the Roll Feed Unit (→P.119)



Note

- Use **Standard Adj.** if you have switched to another type of paper or if you want the boundaries between colors to appear as attractive as possible.
- Use **Advanced Adj.** to fine-tune the space between nozzles or colors if you have switched the printhead or if you want printed documents to appear as vivid as possible. We recommend using **Advanced Adj.** for printing at a higher level of image quality.
- Always make sure the loaded paper matches the media type setting on the printer. Adjustment cannot be completed correctly unless the setting value matches the loaded paper.
- We recommend using the type of paper you use most often for adjustment.
- This function is not available for CAD Tracing Paper, CAD Translucent Matte Film, or CAD Clear Film. If adjustment is not possible as expected using highly transparent film or similar media, try another type of media or adjust the Printhead alignment manually. (→P.586)

2. Press the **Menu** button to display **MAIN MENU**.

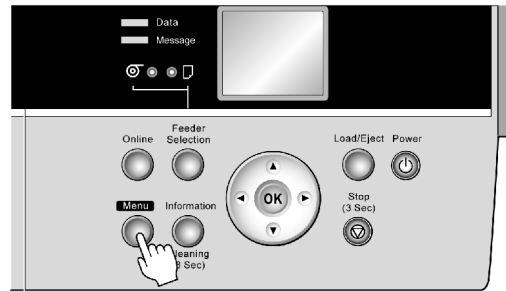

3. Press ▲ or ▼ to select **Adjust Printer**, and then press the ► button.
4. Press ▲ or ▼ to select **Auto Head Adj.**, and then press the ► button.
5. Press ▲ or ▼ to select **Advanced Adj.**, and then press the ► button.
6. Press ▲ or ▼ to select **Yes**, and then press the **OK** button.

A test pattern is printed for printhead adjustment.

After reading the pattern, the printer automatically adjusts the Printhead alignment.



Note

- If paper is fed automatically and no roll is loaded, select the media source and click the **OK** button.

Adjusting the Printhead Alignment Manually

If printed vertical lines are warped or colors are out of alignment, adjust the Printhead alignment. Adjust the Printhead alignment automatically or manually by using a printed test pattern.

You can adjust the Printhead alignment automatically or manually. Normally, choose automatic adjustment. If using special media or printing does not improve even after performing automatic adjustment using advanced adjustment, try manual adjustment. For instructions on automatic adjustment, see “Adjusting the Printhead Alignment Automatically”. (→P.584)

Follow these steps for standard manual adjustment of the Printhead.



Note

- If **Manual Head Adj** is unusable although displayed in the menu, choose **Advanced Adj.** in **Auto Head Adj.** **Manual Head Adj** is available in the menu after you try **Auto Head Adj.** once.



1. When using sheets, have two unused sheets A4-sized or larger ready.

When using a roll, load a roll 10 inches (254 mm) or wider.

- Loading Sheets Manually (→P.156)
- Loading Rolls on the Roll Paper Holder (→P.116)
- Loading Rolls in the Roll Feed Unit (→P.119)



Note

- Always make sure the loaded paper matches the media type setting on the printer. Adjustment cannot be completed correctly unless the setting value matches the loaded paper.
- We recommend using the type of paper you use most often for feed amount adjustment.

2. Press the **Menu** button to display **MAIN MENU**.

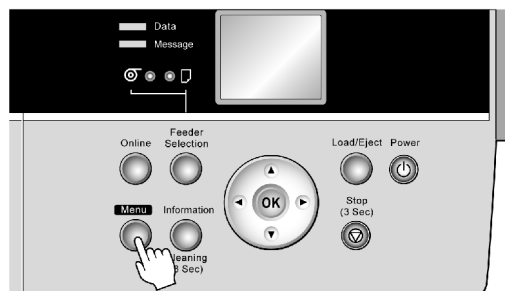

3. Press ▲ or ▼ to select **Adjust Printer**, and then press the ► button.
4. Press ▲ or ▼ to select **Manual Head Adj**, and then press the ► button.
5. Press ▲ or ▼ to select **Yes**, and then press the **OK** button.
A test pattern is printed for printhead adjustment.
6. Press ▲ or ▼ to select **D**, and then press the ► button.
7. Press ▲ or ▼ to select **D-1**, and then press the ► button.

8. Examine test pattern **D-1** for printhead adjustment. After you determine the pattern with straight lines, press ▲ or ▼ to choose the pattern number, and then press the **OK** button.

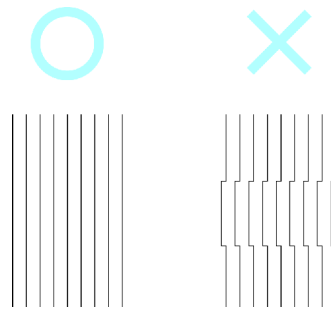
**Note**

- If lines seem straightest in two patterns but you cannot decide which one is better, choose an intermediate value. For example, choose 11 if you cannot decide whether pattern 10 or 12 is better.

9. Repeat steps 7 and 8 to specify the adjustment value for **D-2** to **D-5** and **D-7** to **D-11**.
10. Press the ◀ button.
11. Press ▲ or ▼ to select **Register Setting**, and then press the ▶ button.
12. Press ▲ or ▼ to select **Yes**, and then press the **OK** button.
- The printer now goes online.

Adjusting the Printhead Height

If printed documents rub against the printer during printing or if the edge of paper is wrinkled from rubbing, it may help to raise the Printhead.

If image edges are blurred, it may help to lower the Printhead.

1. Press the **Menu** button to display **MAIN MENU**.

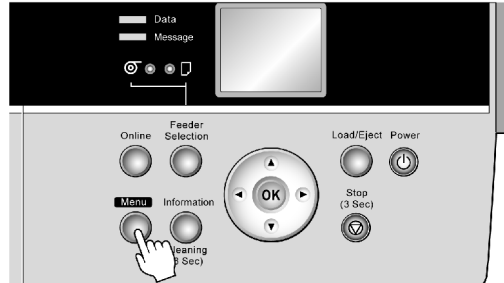

2. Press ▲ or ▼ to select **Paper Details**, and then press the ► button.
3. Press ▲ or ▼ to select the type of paper, and then press the ► button.
4. Press ▲ or ▼ to select **Head Height**, and then press the ► button.
5. Press ▲ or ▼ to select the Printhead height, and then press the **OK** button.

Adjusting the feed amount

Adjusting the Feed Amount Automatically

If printed images are affected by banding in different colors, adjust the amount that paper is fed. There are two modes for adjusting the amount paper is fed, **Standard Adj.** and **Advanced Adj.** **Advanced Adj.** offers a wider range of adjustment than **Standard Adj.** If using **Standard Adj.** does not eliminate streaks, or if streaks are quite noticeable, try **Advanced Adj.**

Follow the steps below for standard automatic adjustment of the feed amount.

When using highly transparent media for which automatic adjustment is not supported, you must adjust the feed amount manually. For instructions on manual adjustment, see "Adjusting the Feed Amount Manually". (→P.592)



Note

- To adjust the measurement scale and ensure accuracy (so that lines in CAD drawings are printed at exactly the right length, for example), specify the amount of paper stretching or shrinkage when adjusting the feed amount. (→P.596)
- This may take some time, depending on the type of paper.



Important

- Use paper of the same type and size for adjustment as you will use for printing.
- To apply the results of adjusting the feed amount in printing, you must first set **Feed Priority** to **Band Joint**. Note that if you select **Automatic**, the results of adjustment will only be applied in printing if you set **Print Priority** in the printer driver to **Image** or **Office Document**. (→P.173)

Follow these steps to change the **Feed Priority** setting.

1. Press the **Menu** button to display **MAIN MENU**.

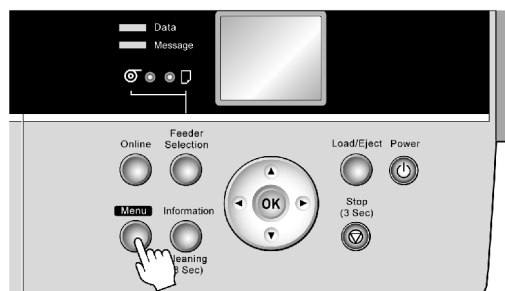

2. Press ▲ or ▼ to select **Paper Details**, and then press the ► button.
3. Press ▲ or ▼ to select the type of paper, and then press the ► button.
4. Press ▲ or ▼ to select **Feed Priority**, and then press the ► button.
5. Press ▲ or ▼ to select **Band Joint**, and then press the **OK** button.

Adjusting the feed amount

Follow the steps below to adjust the feed amount automatically.

1. Load one unused sheet A4/Letter-sized or larger when **Standard Adj.** is selected or two when **Advanced Adj.** is selected.

When using a roll, load a roll 10 inches (254 mm) or wider.

- Loading and Printing on Rolls (→P.80)
- Loading and Printing on Sheets in the Paper Feed Slot (→P.85)



Note

- Always make sure the loaded paper matches the media type setting. Adjustment cannot be completed correctly unless the setting value matches the loaded paper.

2. Press the **Menu** button to display **MAIN MENU**.

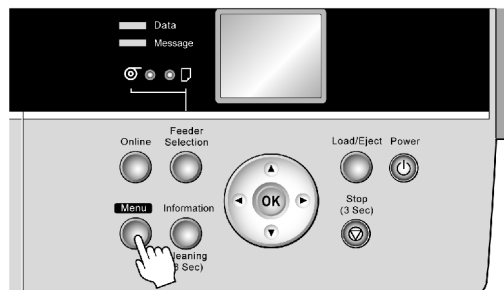

3. Press ▲ or ▼ to select **Adjust Printer**, and then press the ► button.
4. Press ▲ or ▼ to select **Auto Band Adj.**, and then press the ► button.
5. Press ▲ or ▼ to select **Standard Adj.** or **Advanced Adj.**, and then press the ► button.
6. Press ▲ or ▼ to select **Yes**, and then press the **OK** button.

A test pattern is printed for band adjustment.

After reading the pattern, the printer automatically adjusts the feed amount and returns to online mode.



Note

- If paper is fed automatically and no roll is loaded, select the media source and click the **OK** button.
- In some cases, the feed amount cannot be adjusted automatically. If so, choose **Advanced Adj.** in **Auto Band Adj.** (→P.49)
- If printed documents are still affected by uneven contrast or banding in different colors at regular intervals after this adjustment, you can adjust the feed amount during printing. (→P.591)

Adjusting the feed amount during printing

If, during printing, the contrast is uneven sideways across the paper or banding in different colors appears every 40 mm (1.6 in) or so, try adjusting the feed amount as follows. However, note that because printing is paused, colors may be slightly different.

1. Press the **Online** button to pause printing.

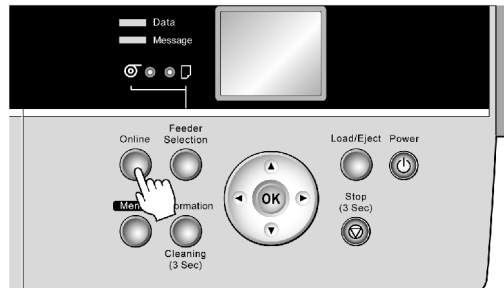

2. Press the **Menu** button to display **Menu Durng Prtng.**

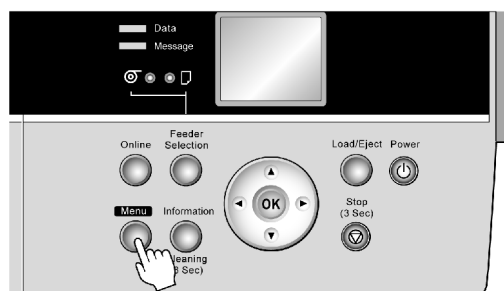

3. Press **▲** or **▼** to select **Fine Band Adj.**, and then press the **OK** button.
4. Press **▲** or **▼** to change the value, and then press the **OK** button.



Note

- The supported range is -5 to +5.

5. Press the **Online** button to resume printing.

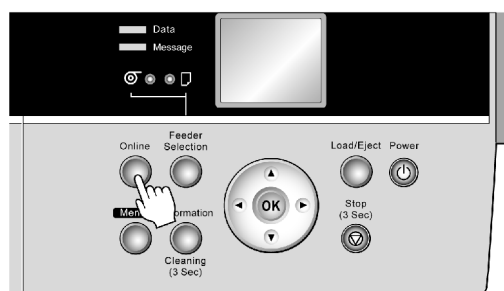

Note

- The **Fine Band Adj.** value set during printing is also applied to the next print job. However, if you adjust the feed amount (manually or automatically), the **Fine Band Adj.** value is reset to 0.

Adjusting the Feed Amount Manually

If printed images are affected by banding in different colors, adjust the amount that paper is fed. This topic describes how to adjust the feed amount manually.

When using highly transparent media for which automatic adjustment is not supported, adjust the feed amount manually. We recommend automatic adjustment for other types of media. For instructions on automatic adjustment, see “Adjusting the Feed Amount Automatically”. (→P.589)



Note

- To adjust the measurement scale and ensure accuracy (so that lines in CAD drawings are printed at exactly the right length, for example), specify the amount of paper stretching or shrinkage when adjusting the feed amount. (→P.596)



Important

- Use paper of the same type and size for adjustment as you will use for printing.
- To apply the results of adjusting the feed amount in printing, you must first set **Feed Priority** to **Band Joint**. Note that if you select **Automatic**, the results of adjustment will only be applied in printing if you set **Print Priority** in the printer driver to **Image** or **Office Document**. (→P.173)

Follow these steps to change the **Feed Priority** setting.

1. Press the **Menu** button to display **MAIN MENU**.

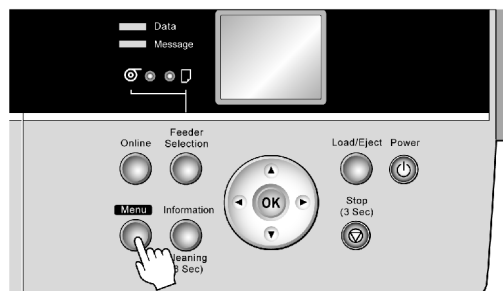

2. Press ▲ or ▼ to select **Paper Details**, and then press the ► button.
3. Press ▲ or ▼ to select the type of paper, and then press the ► button.
4. Press ▲ or ▼ to select **Feed Priority**, and then press the ► button.
5. Press ▲ or ▼ to select **Band Joint**, and then press the **OK** button.

Follow the steps below to adjust the feed amount manually.

1. When using sheets, load two unused sheets A4/Letter-sized or larger.

When using a roll, load a roll 10 inches (254 mm) or wider.

- Loading and Printing on Rolls (→P.80)
- Loading and Printing on Sheets in the Paper Feed Slot (→P.85)



Note

- Always make sure the loaded paper matches the media type setting. Adjustment cannot be completed correctly unless the setting value matches the loaded paper.

2. Press the **Menu** button to display **MAIN MENU**.

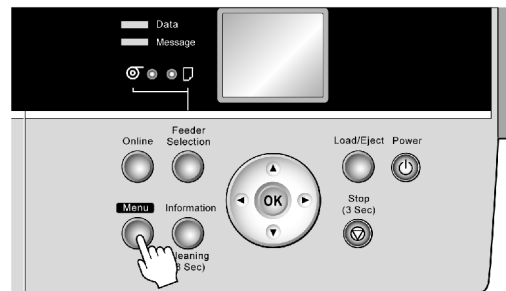

3. Press **▲** or **▼** to select **Adjust Printer**, and then press the **▶** button.

4. Press **▲** or **▼** to select **Manual Band Adj**, and then press the **▶** button.

5. Press **▲** or **▼** to select **Yes**, and then press the **OK** button.

Test pattern A is printed for band adjustment.

6. Examine test pattern A for band adjustment. After you determine the pattern in which streaks are least noticeable, press **▲** or **▼** to choose the pattern number, and then press the **OK** button.

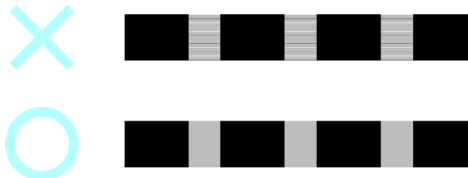

Test pattern B is printed for band adjustment.



Note

- If streaks seem least noticeable in two patterns but you cannot decide which one is better, choose an intermediate value. For example, choose 11 if you cannot decide whether pattern 10 or 12 is better.

7. Examine test pattern B for band adjustment. After you determine the pattern in which streaks are least noticeable, press **▲** or **▼** to choose the pattern number, and then press the **OK** button.

The feed amount is adjusted, and the printer goes online.

If printed documents are still affected by uneven contrast or banding in different colors at regular intervals after this adjustment, you can adjust the feed amount during printing. (→P.594)

Adjusting the feed amount during printing

If, during printing, the contrast is uneven sideways across the paper or banding in different colors appears every 40 mm (1.6 in) or so, try adjusting the feed amount as follows. The results of adjustment are applied to printing in progress, enabling you to check the results immediately. However, note that because printing is paused, colors may be slightly different.

1. Press the **Online** button to pause printing.

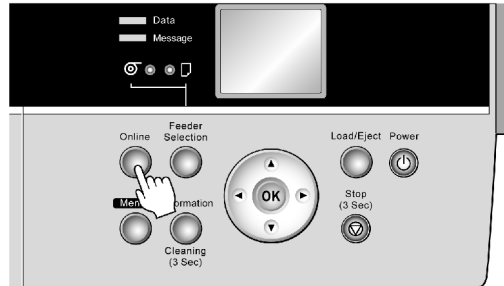

2. Press the **Menu** button to display **Menu Durng Prtng**.

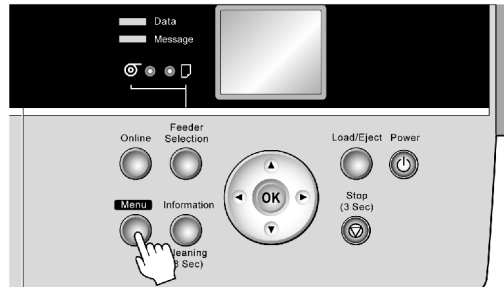

3. Press **▲** or **▼** to select **Fine Band Adj.**, and then press the **OK** button.
4. Press **▲** or **▼** to change the value, and then press the **OK** button.



Note

- The supported range is -5 to +5.

5. Press the **Online** button to resume printing.

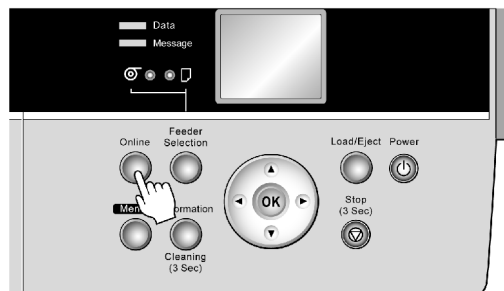

Note

- The **Fine Band Adj.** adjustment value set during printing is also applied to the next print job. However, if you adjust the Printhead alignment, the **Fine Band Adj.** value is reset to 0.

Adjusting the Vacuum Strength

When printing on heavyweight paper or paper that curls or wrinkles easily, if paper rubs against the printer or the edge is wrinkled from rubbing, adjusting the level of suction against paper on the Platen may improve results.

1. Press the **Menu** button to display **MAIN MENU**.

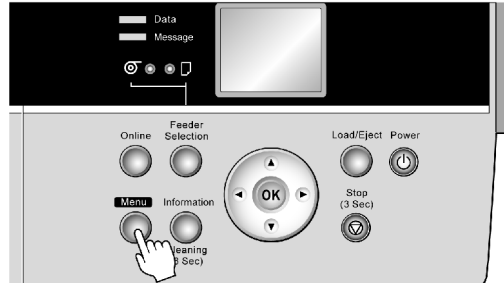

2. Press ▲ or ▼ to select **Paper Details**, and then press the ► button.
3. Press ▲ or ▼ to select the type of paper, and then press the ► button.
4. Press ▲ or ▼ to select **Vacuum Strength**, and then press the ► button.
5. Press ▲ or ▼ to select the level of suction against paper on the Platen, and then press the **OK** button.

Adjusting the Measurement Scale for Better Accuracy

To adjust the measurement scale and ensure accuracy (so that lines in CAD drawings are printed at exactly the right length, for example), specify the amount of paper stretching or shrinkage when adjusting the feed amount.



Note

- If printed images are affected by banding in different colors, adjust the amount that paper is fed. (→P.592)



Important

- Use paper of the same type and size for adjustment as you will use for printing.
- To apply the results of adjusting the measurement scale for better accuracy in printing, you must first set **Feed Priority** to **Print Length**. Note that if you select **Automatic**, the results of adjustment will only be applied in printing if you set **Print Priority** in the printer driver to **Line Drawing/Text**. (→P.173)
Follow these steps to change the **Feed Priority** setting.

1. Press the **Menu** button to display **MAIN MENU**.

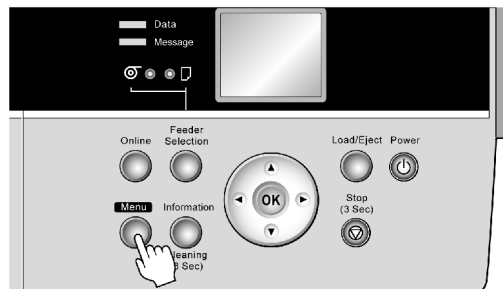

2. Press ▲ or ▼ to select **Paper Details**, and then press the ► button.
3. Press ▲ or ▼ to select the type of paper, and then press the ► button.
4. Press ▲ or ▼ to select **Feed Priority**, and then press the ► button.
5. Press ▲ or ▼ to select **Print Length** or **Automatic**, and then press the **OK** button.

Follow these steps to adjust the scale for better accuracy.

1. When using sheets, load one unused sheet A4/Letter-sized or larger.

When using a roll, load a roll 10 inches (254 mm) or wider.

- Loading Rolls on the Roll Paper Holder (→P.116)
- Loading Rolls in the Roll Feed Unit (→P.119)
- Loading Sheets Manually (→P.156)



Note

- When loading paper, specify the correct paper type. When the paper type is not specified, the printing quality may be affected without the correct adjustment of the feeding.
- We recommend using the type of paper you use most often for feed amount adjustment.

2. Press the **Menu** button to display **MAIN MENU**.

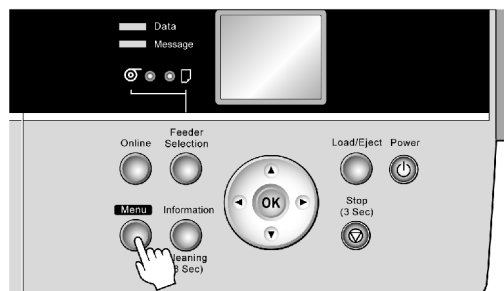

3. Press **▲** or **▼** to select **Adjust Printer**, and then press the **▶** button.

4. Press **▲** or **▼** to select **Adjust Length**, and then press the **▶** button.

5. Press **▲** or **▼** to select **Yes**, and then press the **OK** button.

A test pattern is printed for adjustment based on the amount of paper stretching or shrinkage.

The scale bar shows “Millimeter” in 50 mm units and “Inch” in 1 inch units.

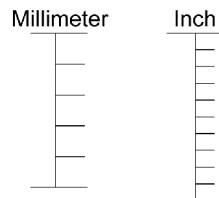

6. Measure the length of the adjustment pattern. Calculate the difference between the measured length and actual length. Enter it as a percentage and press the **OK** button.

You can adjust the value in 0.02% increments. Press **▲** to increase the value and **▼** to decrease it.

If the scale is printed shorter than actual size, set the value toward the positive side; if it is printed longer, set the value toward the negative side.



Note

- You can also specify the adjustment value by selecting **Paper Details** → **Adjust. Setting**.

Adjusting Color on the Trailing Edge of Sheets

If printed sheets are affected by banding in different colors toward the end of the sheet (about 20-30 mm from the edge), try adjusting the feed amount of the trailing edge of sheets.



Note

- If printed documents (including documents printed on rolls) are affected by banding in different colors not only toward the end of the sheet but throughout the printed area, try adjusting the overall feed amount. (→P.589)
- This adjustment is only possible when feeding paper from the Top Paper Feed Slot that can be set up with a margin on the trailing edge of 3 mm (0.12 in). If you use paper for which you cannot specify a trailing margin of 3 mm, it will be automatically ejected, and adjustment is not possible.

1. Load a sheet of unused paper A4/Letter-sized or larger.



Note

- Always make sure the loaded paper matches the media type setting on the printer. Adjustment cannot be completed correctly unless the setting value matches the loaded paper.
- We recommend using the type of paper you use most often for adjustment.

2. Press the **Menu** button to display **MAIN MENU**.

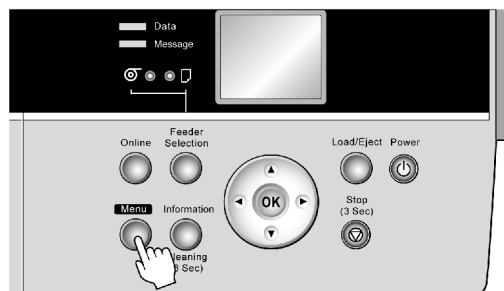

3. Press **▲** or **▼** to select **Adjust Printer**, and then press the **▶** button.
4. Press **▲** or **▼** to select **Adj Far Ed Feed**, and then press the **▶** button.
5. Press **▲** or **▼** to select **Yes**, and then press the **OK** button.

A test pattern is printed for adjustment.

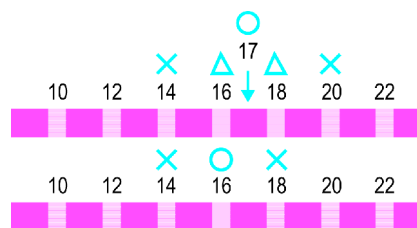

C1 is displayed on the Control Panel.

6. Examine test pattern **C1** for adjustment. After you determine the pattern in which streaks are least noticeable, press the **▲** or **▼** to choose the pattern number, and then press the **OK** button. **C2** is displayed on the Control Panel.

7. Examine test pattern **C2** for adjustment. After you determine the pattern in which streaks are least noticeable, press the ▲ or ▼ to choose the pattern number, and then press the **OK** button. The printer now goes back online.

**Note**

- If streaks seem least noticeable in two patterns but you cannot decide which one is better, choose an intermediate value. For example, choose 17 if you cannot decide whether pattern 16 or 18 is better.

Color adjustment

Using Color Calibration to Adjust Colors

Color calibration is a feature that compensates for changes in color from individual variation among Printhead or from the printing environment, ensuring better color consistency.

We recommend using color calibration in the following situations.

- After initial installation
- After Printhead replacement
- If colors seem different from before (however, make sure you are printing under the same conditions and in the same printing environment)
- When consistent color is desired from multiple printers (in this case, also use the same version of firmware and printer driver and the same settings.)

When you execute color calibration, a test pattern is printed and an adjustment value is automatically set based on the results of printing.



Important

- Before executing color calibration, you must prepare one of the following types of paper. Note that various environmental conditions are recommended for various types of paper. Use the printer under the recommended environmental conditions for the paper to be used. For details on recommended environmental conditions for various paper, see the Paper Reference Guide. (→P.108)

Paper Compatible With Color Calibration	Japan	Europe	Americas
Matte Coated 90	-	Compatible	Compatible
HW Coated	Compatible	Compatible	Compatible
Premium MatteP	Compatible	Compatible	Compatible
Matte Photo	Compatible	Compatible	Compatible
GlossyPhoto 190	-	Compatible	Compatible
SatinPhoto 190	Compatible	Compatible	Compatible
GlossyPhoto 240	-	Compatible	Compatible
SatinPhoto 240	-	Compatible	Compatible
Glossy Photo	Compatible	Compatible	Compatible
HW GlossyPhoto2	Compatible	Compatible	Compatible
HW SemiGIPhoto2	Compatible	Compatible	Compatible
Photo PaperPlus	Compatible	Compatible	Compatible
FineArt Photo	Compatible	Compatible	Compatible
FneArt HW Photo	Compatible	Compatible	Compatible
Comm Proofing	-	Compatible	Compatible

RC Proofing 210	-	Compatible	Compatible
Proofing Paper	Compatible	Compatible	Compatible
Opaque Paper	-	Compatible	-
Art Extr Smooth	-	Compatible	-

- Optimal adjustment values from color calibration are also applied for paper other than the type you use to execute color calibration when printing on that other type of paper.
- In the printer driver or in the **MAIN MENU** of the Control Panel, you can specify whether to apply the adjustment value from color calibration when printing. The printer driver settings are given priority. For menu details, see “Main Menu Settings”. (→P.49)
For information on printer driver settings, refer to the following topics.
 - Printer Driver Settings (Windows) (→P.441)
 - Printer Driver Settings (Mac OS X) (→P.492)
 - Printer Driver Settings (Mac OS 9) (→P.517)
- Before color calibration, ensure the printer is not exposed to direct sunlight or other strong sources of light.
- If you reinstall the printer driver and change the region selection of the Media Configuration Tool, region-specific paper information originally registered on the printer before installation will be deleted. If the information of paper you used for color calibration is deleted, such color calibration can no longer be applied to any type of paper. To apply the results of color calibration, perform color calibration again using paper supported in the newly selected region and compatible with color calibration. See the Media Configuration Tool Guide (Windows) or Media Configuration Tool Guide (Macintosh)
- Default settings will be restored if you select **MAIN MENU > System Setup > Reset PaprSetngs > Yes**. Because information added or updated using the Media Configuration Tool is also deleted, if paper of which information was added using the Media Configuration Tool was used for color calibration and is now deleted, such color calibration can no longer be applied to any type of paper. To apply the results of color calibration, perform color calibration again using a paper included originally in the default settings that is compatible with color calibration. See the Media Configuration Tool Guide (Windows) or Media Configuration Tool Guide (Macintosh).



Note

- For further adjustment of the color of documents as printed applying color calibration, adjust the color in the printer driver. (→P.184)
- You can check when color calibration was executed and what paper was used from **Status Print**, imagePROGRAF Status Monitor (in Windows) or imagePROGRAF Printmonitor (on a Macintosh computer) in the **MAIN MENU** on the Control Panel. For menu details, see “Main Menu Settings”. (→P.49)
For details on imagePROGRAF Status Monitor, refer to the imagePROGRAF Status Monitor help.
For details on imagePROGRAF Printmonitor, refer to the imagePROGRAF Printmonitor help.

Color adjustment

Follow these steps to execute color calibration.

1. Load paper compatible with color calibration.

When using sheets, load paper A4 (210.0×297.0 mm)/Letter (8.5×11 in) vertical, or larger. One sheet is required.

When using a roll, load a roll 10 inches (254 mm) or wider.

- Loading and Printing on Rolls (→P.80)
- Loading and Printing on Sheets in the Paper Feed Slot (→P.85)

2. Press the **Menu** button to display **MAIN MENU**.

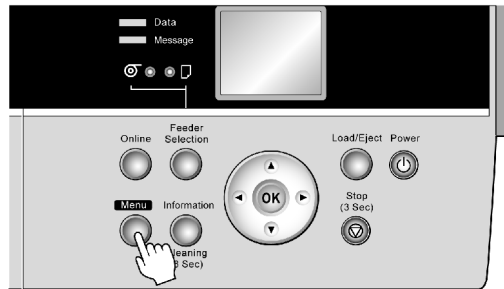

3. Press ▲ or ▼ to select **Adjust Printer**, and then press the ► button.

4. Press ▲ or ▼ to select **Calibration**, and then press ►.

5. Press ▲ or ▼ to select **Auto Adjust**, and then press the ► button.

6. Press ▲ or ▼ to select **Yes**, and then press the **OK** button.

After the printer measures environmental conditions and checks the paper, a test pattern for color calibration is printed. An adjustment value based on the results of printing is set automatically.

After adjustment is complete, the printer goes online or offline automatically.

■ ■ ■ Printing in Ideal Colors for Light in the Viewing Environment

You can print in the colors that look best when viewed under the light where the printed image will be displayed. There are two ways to adjust the color tone for the ambient light, as follows.

By selecting color tones on Charts before printing

On the printed **Chart**, note the number of the set of colors with the desired color tone and enter this number in the printer driver before printing.



Important

- This function requires that the **Light Source Check Tool** be installed.
- You can install the **Light Source Check Tool** from the User Software CD-ROM.
- This function is only supported in Windows.

For instructions on selecting color tones on **Charts** before printing, refer to the following topic:

- By selecting color tones on Charts before printing (Windows) (→P.604)

Printing in Colors Matching the Measured Ambient Light

Measure the light level in the viewing environment and enter the results in the printer driver before printing.



Important

- This function requires the Eye-One spectrophotometer. The Light Source Measure Tool must also be installed.
- You can install the Light Source Measure Tool from the User Software CD-ROM.
- For a list of supported Eye-One devices, refer to the manual provided with the Light Source Measure Tool.
- This function is only supported in Windows.

For instructions on measuring light levels before printing, refer to the following topic:

- Printing in Colors Matching the Measured Ambient Light (→P.608)

By selecting color tones on Charts before printing (Windows)

Print **Charts**, note the number of the chart with your desired color tone, and enter this number in the printer driver before printing.



Important

- This function requires that the **Light Source Check Tool** be installed.
- You can install the **Light Source Check Tool** from the User Software CD-ROM.

1. Choose **Print** in the application menu.
2. Select the printer in the dialog box, and then display the printer driver dialog box. (→P.473)
3. Make sure the **Main** sheet is displayed.

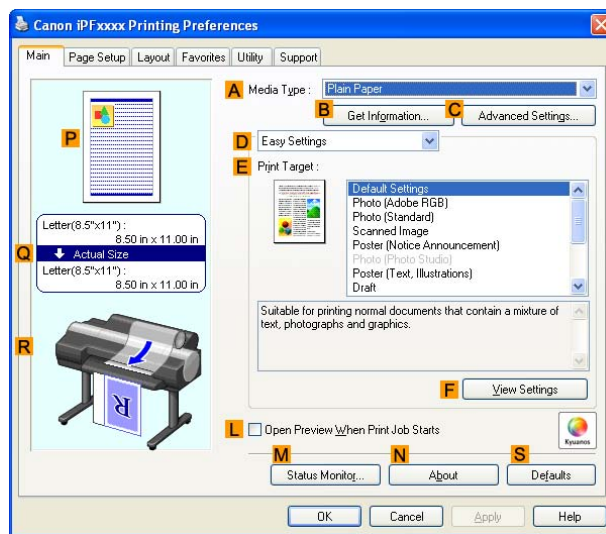

4. In the **Media Type** list, select the type of paper that is loaded (for example, Glossy Photo Paper).



Important

- **Ambient Light Matching Mode (Kyuanos)** may not be available, depending on the type of paper used. For details, see “Types of Paper”. (→P.108)

5. Click **D** **Advanced Settings** to switch the print mode.

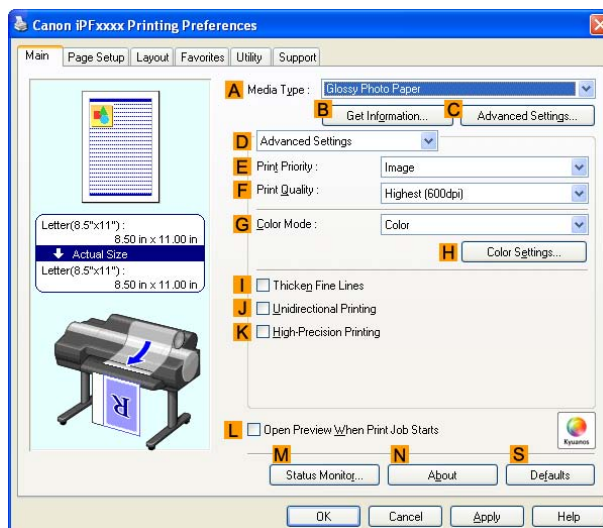

6. In **F** **Print Quality**, click **Highest** or **High**.



Important

- Ambient Light Matching mode is only available when the **F** **Print Quality** is set to **Highest** or **High**.

7. Click **Color** in the **G** **Color Mode** list.

8. Click **H** **Color Settings** to display the **Color Settings** dialog box.

9. Click the **Matching** tab to display the **Matching** sheet.

10. Click **Ambient Light Matching Mode (Kyuanos)** in the **A** **Matching Mode** list.

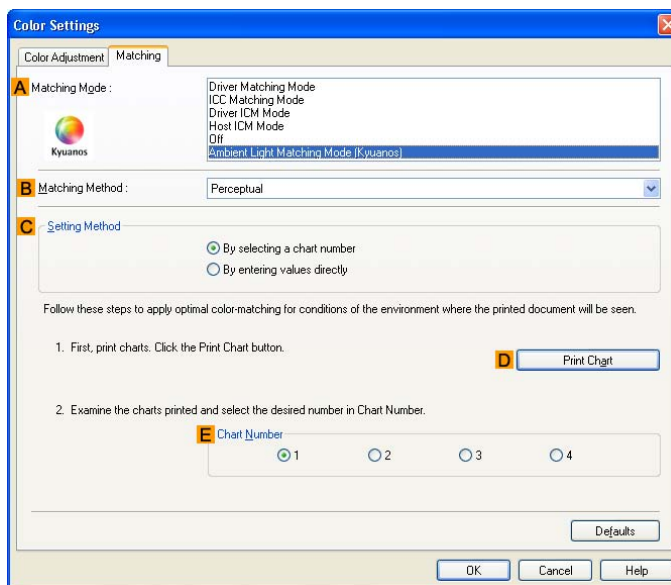

11. Confirm that **By selecting a chart number** is selected in **C** **Setting Method**.
If it is not selected already, select it.

- Click **D Print Chart**.
Light Source Check Tool now starts up.

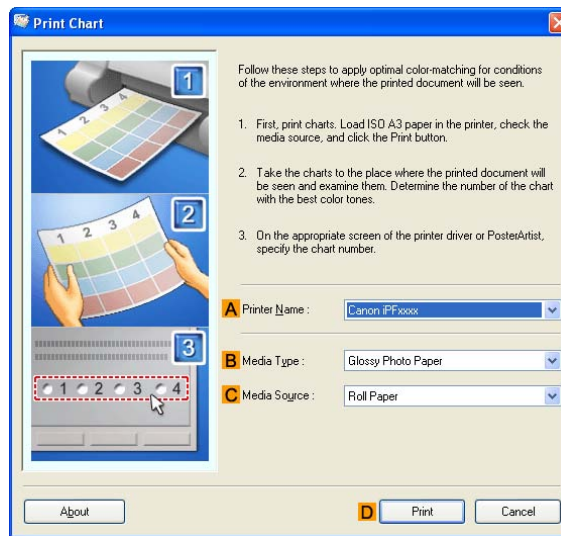

- Check the settings and click **Print**.
The **Chart** is printed.

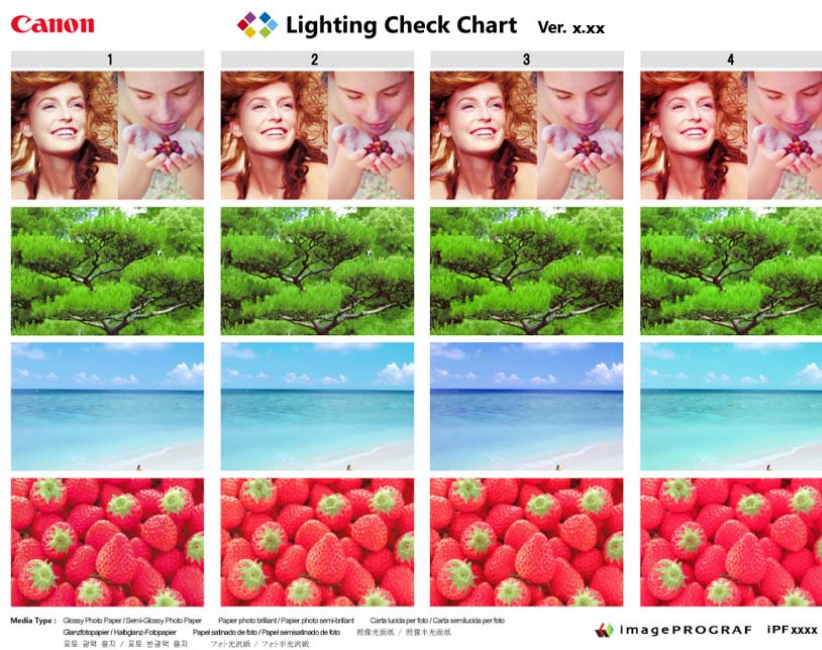

- In the viewing environment, determine the number of the set of images on the **Chart** in which all four vertical images have the best overall color tone.



Note

- Choose the number of the set of images in which the people, the blue of the sky, and the red of the strawberries look the most natural overall.

15. After confirming that **Ambient Light Matching Mode (Kyuanos)** is selected in **A Matching Mode**, select the number for the desired color tone on the chart in **E Chart Number**.

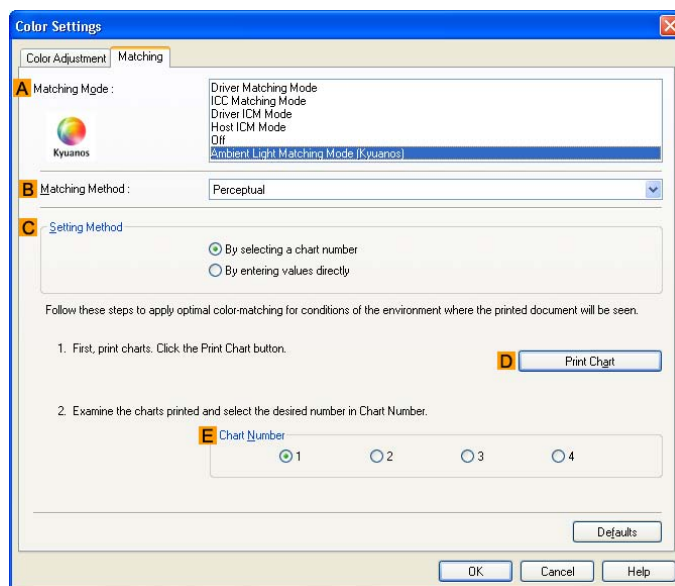

16. Click **OK**.
17. Confirm the print settings and start printing.

Printing in Colors Matching the Measured Ambient Light

Measure the light level in the viewing environment and enter the results in the printer driver before printing.



Important

- This function requires the Eye-One spectrophotometer. The Light Source Measure Tool must also be installed.
- You can install the Light Source Measure Tool from the User Software CD-ROM.
- For a list of supported Eye-One devices, refer to the manual provided with the Light Source Measure Tool.

1. Using the Eye-One spectrophotometer and the Light Source Measure Tool, determine the **Lighting Source Type** and **Color Temperature** in the viewing environment.



Note

- For detailed instructions on Eye-One and the Light Source Measure Tool, refer to the provided instructions.

2. Choose **Print** in the application menu.
3. Select the printer in the dialog box, and then display the printer driver dialog box. (→P.473)
4. Make sure the **Main** sheet is displayed.

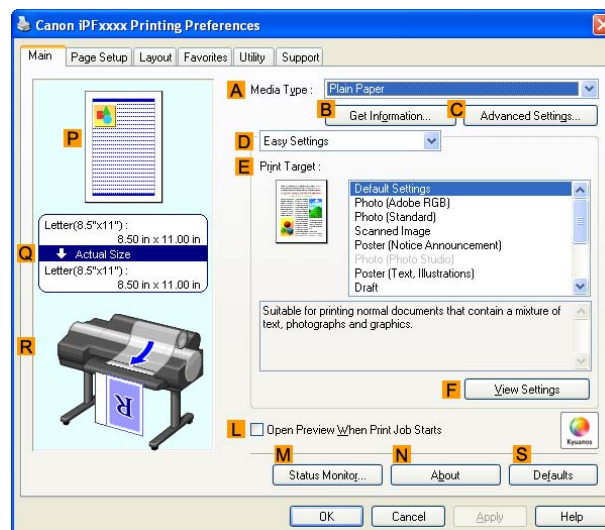

5. In the **A Media Type** list, select the type of paper that is loaded (for example, Glossy Photo Paper).



Important

- **Ambient Light Matching Mode (Kyanos)** may not be available, depending on the type of paper used. For details, see "Types of Paper". (→P.108)

6. Click **D** **Advanced Settings** to switch the print mode.

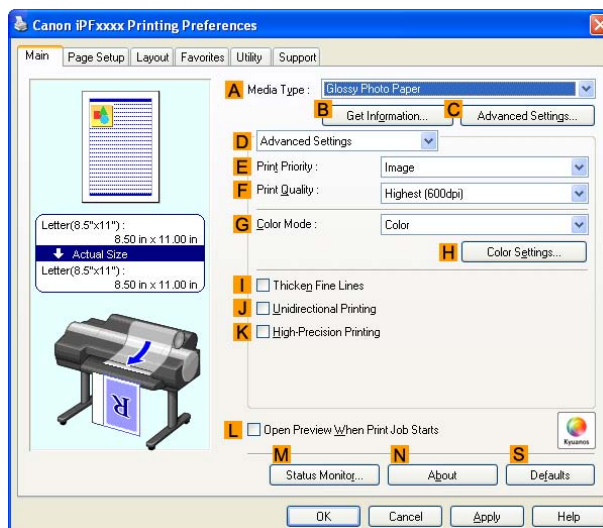

7. In **F** **Print Quality**, click **Highest** or **High**.



Important

- Ambient Light Matching mode is only available when the **F** **Print Quality** is set to **Highest** or **High**.

8. Click **Color** in the **G** **Color Mode** list.

9. Click **H** **Color Settings** to display the **Color Settings** dialog box.

10. Click the **Matching** tab to display the **Matching** sheet.

11. Click **Ambient Light Matching Mode (Kyuanos)** in the **A** **Matching Mode** list.

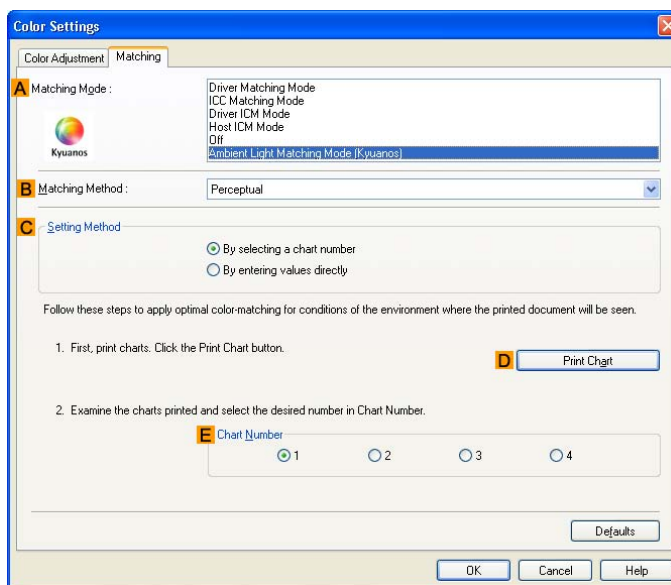

12. Select **By entering values directly in **C** Setting Method.**

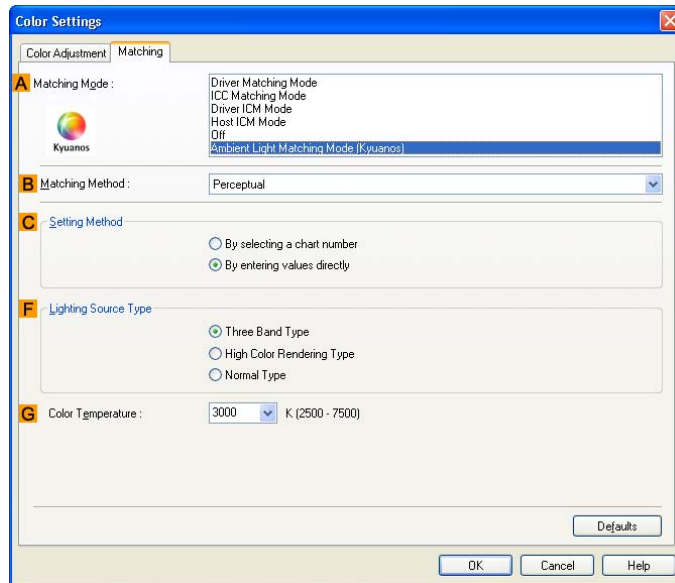

13. Select the **F Lighting Source Type and **G** Color Temperature determined in step 1.**

14. Click **OK.**

15. Confirm the print settings and start printing.

Accessing the Printer Driver Dialog Box from Applications (Windows)

1. Choose **Print** from the **File** menu to display the dialog box for printing conditions.
2. Select the printer, and then display the printer driver dialog box.



Note

- The dialog box for specifying printing conditions varies depending on the source application. In some cases, when you select the printer, a sheet for configuring the printer driver is added to the dialog box. In the following case, click **Preferences**.

■ Example: Print dialog box displayed by the application software

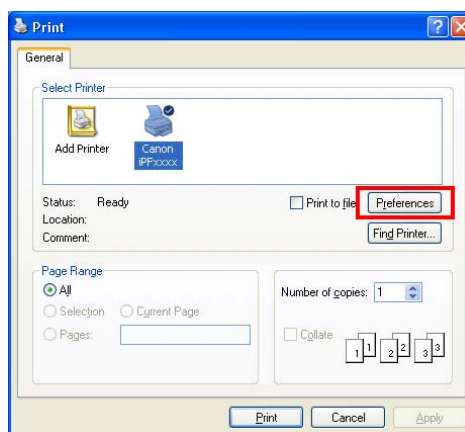

Six sheets of print settings are displayed by the printer driver: **Main**, **Page Setup**, **Layout**, **Favorites**, **Utility**, and **Support**.

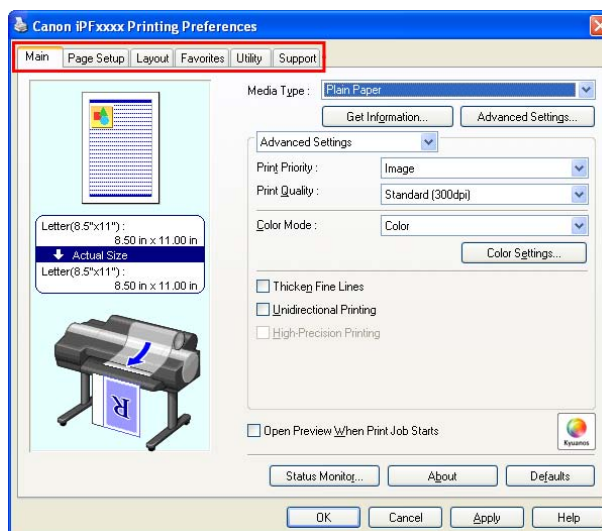

Note

- The titles of dialog boxes may vary depending on the application, and sheets other than these six sheets may be displayed.



Important

- If you access the printer driver dialog box from the source application, changes you make to the settings will only apply temporarily to that application. Because these are sizes you specify temporarily in the printer driver, the sizes will not be available after you exit the application.
- You can also access the printer driver dialog box from the Windows system menu. see “Accessing the Printer Driver Dialog Box from the Operating System Menu (Windows)”. (→P.149)

Ink Tanks

☐ Ink Tank

An Ink Tank that can be used in the printer is labeled with a white letter “H” in a black circle on the side. When purchasing an Ink Tank, make sure an “H” is printed on the label, along with the following Ink Tank part numbers.

- Y Ink Tank PFI-101Y
 - PC Ink Tank PFI-101PC
 - C Ink Tank PFI-101C
 - PGY Ink Tank PFI-103PGY
 - GY Ink Tank PFI-103GY
 - BK Ink Tank PFI-103BK
 - PM Ink Tank PFI-101PM
 - M Ink Tank PFI-101M
 - MBK Ink Tank PFI-103MBK
 - R Ink Tank PFI-101R
 - G Ink Tank PFI-101G
 - B Ink Tank PFI-101B
- 130 ml per color

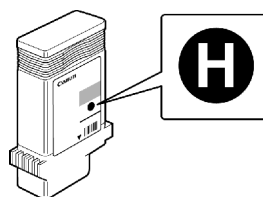

Note

- For instructions on replacing Ink Tank, see “Replacing Ink Tanks”. (→P.614)

Replacing Ink Tanks

Compatible Ink Tank

An Ink Tank that can be used in the printer is labeled with a white letter “H” in a black circle on the side. Request an Ink Tank with the same label when you purchase a new Ink Tank. For more information, see “Ink Tank”. (→P.613)

Precautions when handling an Ink Tank

Take the following precautions when handling an Ink Tank.



Caution

- For safety, keep an Ink Tank out of the reach of children.
- If ink is accidentally ingested, contact a physician immediately.



Important

- Before removing an Ink Tank from the pouch for installation, shake it gently seven or eight times. If you do not shake the Ink Tank, the ink may sediment, which may affect printing quality.
- Do not remove and shake an Ink Tank that has already been installed in the printer. Ink may leak out.
- Avoid dropping the Ink Tank after removing it from the pouch. Otherwise, ink may leak and cause stains.
- There may be ink around the ink holes of Ink Tank you remove. Handle an Ink Tank carefully during replacement. The ink may stain clothing.
- We recommend using up an Ink Tank in the course of printing within six months after breaking the seal. Using an old Ink Tank may affect the printing quality.
- Do not remove the Ink Tank if the printer is not used for a long period (a month or more). Ink remaining in the printer may become clogged and cause of printing problems.
- Coverage may be uneven if you replace the ink during a print job.

Replacing an Ink Tank

1. Make sure no print jobs are in progress.

You can replace Ink Tank if the Display Screen indicates the printer is **Online** or **Offline**, or if messages advise you to check the amount of ink left or replace the Ink Tank.

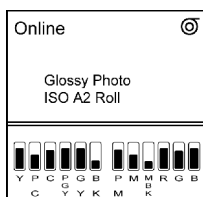

If a message prompts you to replace the Ink Tank, press the **OK** button. Steps 2 and 3 are unnecessary in this case. Go to step 4 and remove the Ink Tank.

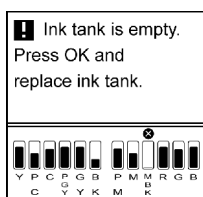

Do not remove an Ink Tank during initialization immediately after turning on the printer, or during printing or printhead cleaning.



Note

- Ink Tank replacement is possible even when print jobs are being canceled or if paper is being fed.

2. Press the **Menu** button to display **MAIN MENU**.

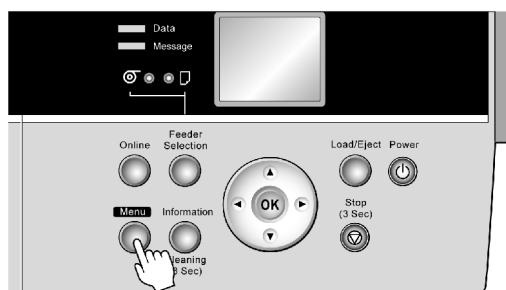

3. Press **▲** or **▼** to select **Rep. Ink Tank**, and then press the **▶** button.

4. Press **▲** or **▼** to select **Yes**, and then press the **OK** button.

A message on the Display Screen advises you to open the Ink Tank Cover. Next, remove the Ink Tank.

5. Open the Ink Tank Cover and check the Ink Lamp.
The Ink Lamp flashes quickly if there is no ink left.

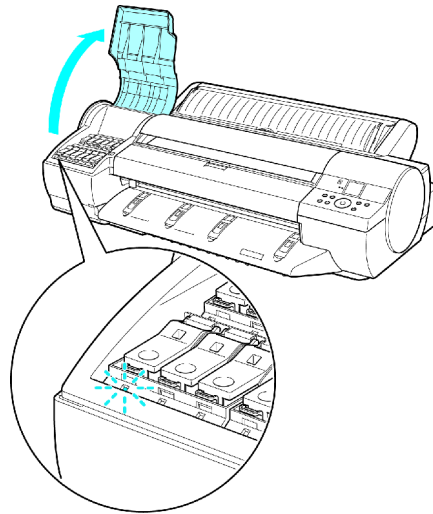

6. Press the tip of the Ink Tank Lock Lever of the color for replacement and lift the Ink Tank Lock Lever to open it.

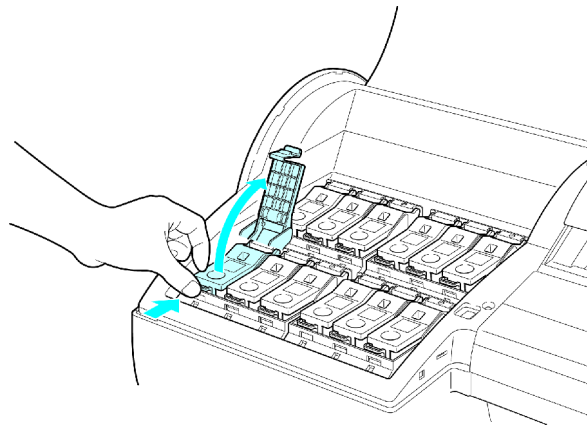

7. Hold the empty Ink Tank by the grip to remove it, and press the **OK** button.

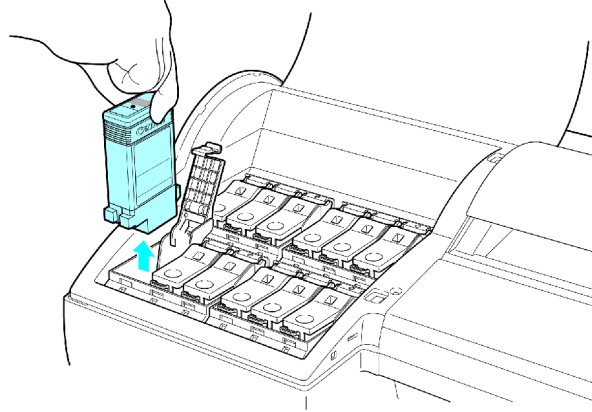

Note

- If there is still some ink left in the Ink Tank you removed, store the ink tank with the ink holes (a) facing up. Otherwise, ink may leak and cause stains. Put the Ink Tank in a plastic bag and seal it.

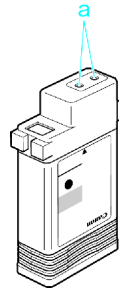

- Dispose of used Ink Tank according to local regulations.

8. Before opening the pouch, shake the Ink Tank gently seven or eight times. Agitate the ink in the Ink Tank by slowly turning the Ink Tank upside-down and right side up several times.

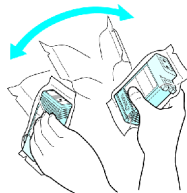

Note

- If you do not shake the Ink Tank, the ink may sediment, which may affect printing quality.

9. Open the pouch and remove the Ink Tank.

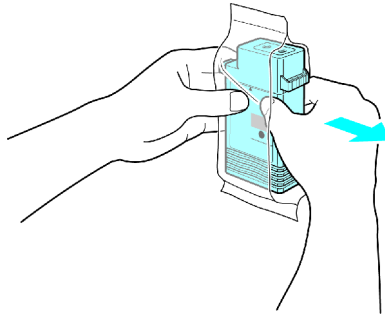

Note

- Never touch the ink holes or metal contacts. This may cause stains, damage the Ink Tank, and affect printing quality.
- Avoid dropping the Ink Tank after removing it from the pouch. Otherwise, ink may leak and cause stains.
- Do not remove and shake an Ink Tank that has already been installed in the printer. Ink may leak out.

10. Press the **OK** button and insert the Ink Tank into the holder facing as shown in the figure, with the ink holes down.

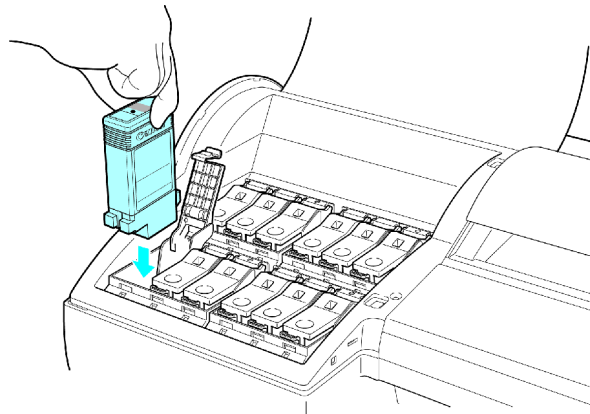

Important

- Ink Tank cannot be loaded in the holder if the color or orientation is wrong. If the Ink Tank does not fit in the holder, do not force it into the holder. Make sure the color of the Ink Tank Lock Lever matches the color of the Ink Tank, and check the orientation of the Ink Tank before reloading it.

11. Close the Ink Tank Lock Lever until it clicks.

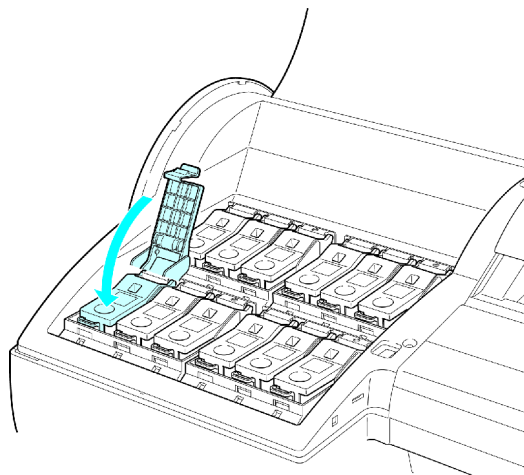

12. Make sure the Ink Lamp is lit in red.

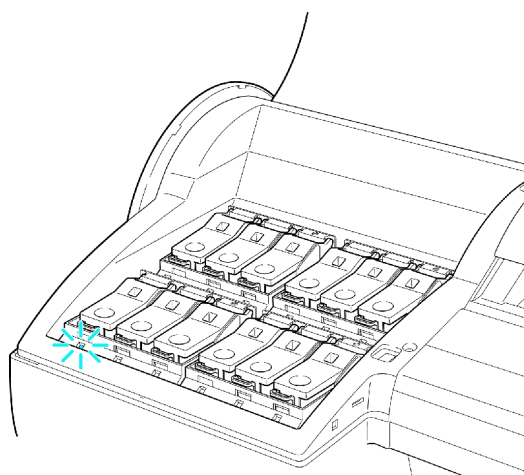

Note

- Ink Lamp flashes when there is little ink left.

13. Close the Ink Tank Cover.

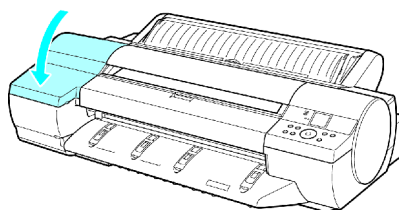

The printer returns to the mode before replacement of Ink Tank.

☐ Checking Ink Tank Levels

On the Display Screen, you can check how much ink is left in the Ink Tank.

The Display Screen indicates the remaining ink levels, unless a message is displayed.

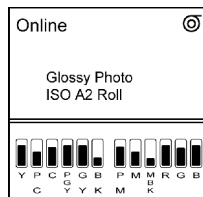

During messages, press the **Information** button to view the ink levels on the Display Screen.

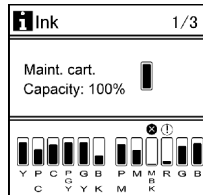

These levels shown on the Display Screen correspond to the inks identified by the Color Label on the bottom of the Display Screen.

These symbols may be displayed above the ink level: “!” if ink is low, “x” if no ink is left, and “?” if you have deactivated ink level detection.

The remaining ink level is indicated as shown below.

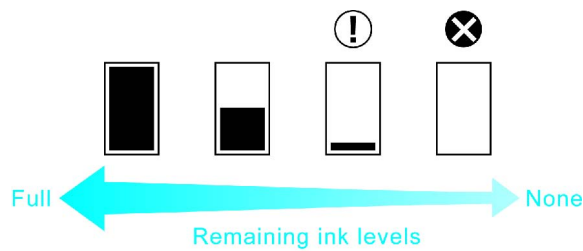

If the Display Screen indicates to replace the Ink Tank, replace the Ink Tank. If a message is displayed indicating to check the remaining ink levels, or after tasks that consume a lot of ink such as large-format printing or head cleaning, check the remaining levels and replace Ink Tank as needed. (→P.614)

When to Replace Ink Tanks

Replace or prepare to replace Ink Tank in the following situations.

If a message for checking the ink is shown on the Display Screen

When there is little ink left, the **Message lamp** is lit and **Ink Level: Check** is shown on the Display Screen. You can continue to print, but prepare to replace the Ink Tank. (→P.620)

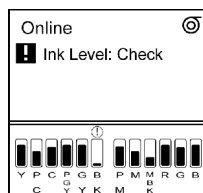

Before print jobs and maintenance that consume a lot of ink

If little ink is left, there may not be enough for large-format printing, head cleaning, and maintenance, which require a lot of ink. In this case, replace or prepare to replace the Ink Tank before maintenance.

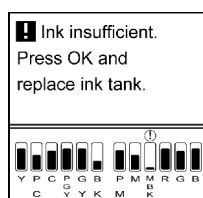

If a message for ink replacement is shown on the Display Screen

When ink runs out, the **Message lamp** flashes, a message regarding Ink Tank replacement is shown on the Display Screen, and printing is disabled. Replace the Ink Tank at this point.

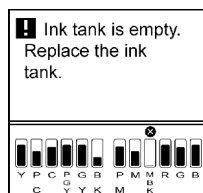

Printheads

Printhead

This is a replacement Printhead for the printer.

- Printhead PF-03

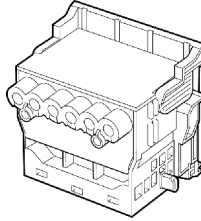

Note

- For instructions on replacing the Printhead, see “Replacing the Printhead”. (→P.625)

Checking the Print Quality

If printing is faint or streaked in different colors, make sure the Printhead nozzles are clear by printing a test pattern to check the nozzles.

For instructions, see “Checking for Nozzle Clogging”. (→P.623)

Improving the Print Quality

If printing is faint or streaked in different colors, make sure the Printhead nozzles are clear by printing a test pattern to check the nozzles. Clean the Printhead if the printed test pattern was faint.

For instructions on cleaning the Printhead, see “Cleaning the Printhead”. (→P.624)

☐ Checking for Nozzle Clogging

If printing is faint or streaked in different colors, make sure the Printhead nozzles are clear by printing a test pattern to check the nozzles.



Note

- You can specify a number of pages in the printer's **Noz. Check Freq.** menu for automatic nozzle checking every time you finish printing that quantity. (→P.49)

- Load unused paper.
 - Loading and Printing on Rolls (→P.80)
 - Loading and Printing on Sheets in the Paper Feed Slot (→P.85)
- Press the **Menu** button to display **MAIN MENU**.

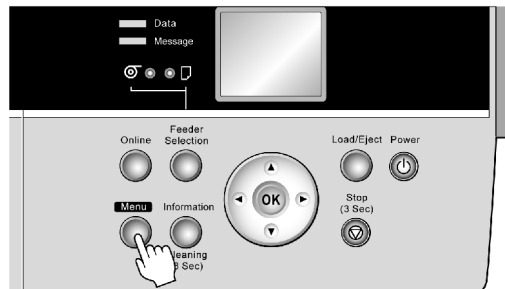

- Press **▲** or **▼** to select **Test Print**, and then press the **▶** button.
 - Press **▲** or **▼** to select **Nozzle Check**, and then press the **▶** button.
 - Press **▲** or **▼** to select **Yes**, and then press the **OK** button.
- The printer goes online and prints a test pattern.
- Check the printing results.

If the horizontal lines are not faint or incomplete, the nozzles are clear.

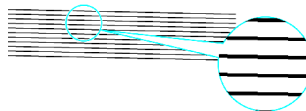

If some sections of the horizontal lines are faint or incomplete, the nozzles for those colors are clogged.

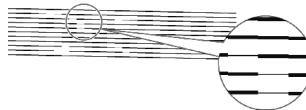

If horizontal lines are faint or incomplete, follow the steps below and check again for nozzle clogging.

- Clean the Printhead. (→P.624)
- Print a test pattern to check the nozzles.



Note

- If you repeat these steps several times but the horizontal lines are still faint or incomplete, contact your Canon dealer.

Cleaning the Printhead

Cleaning the Printhead may help clear nozzles that are clogged.



Note

- You can specify a number of pages in the printer's **Noz. Check Freq.** menu for automatic nozzle checking and cleaning every time you finish printing that quantity. (→P.49)
- You can start **Head Cleaning A** by holding down the **Information** button for three seconds or more.
- Printhead cleaning is not possible if POP Board (1.5 mm [0.06 in] thick) is loaded in the Front Paper Feed Slot. Remove the paper before cleaning.

Cleaning the Printhead

1. Press the **Menu** button to display **MAIN MENU**.

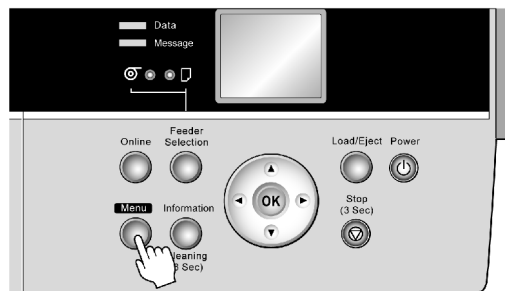

2. Press **▲** or **▼** to select **Head Cleaning**, and then press the **►** button.
3. Press **▲** or **▼** to select the type of cleaning, and then press the **OK** button.

- **Head Cleaning A**

Use **Head Cleaning A** if printing is faint or contains foreign substances. This method of cleaning consumes the least amount of ink. It takes about four minutes to complete.

- **Head Cleaning B**

Use **Head Cleaning B** if no ink comes out of the printhead, or if **Head Cleaning A** does not solve the problem. It takes about five minutes to complete.

The printhead is cleaned, and the printer goes online.

4. Print a test pattern to check the nozzles, and determine whether cleaning has cleared the nozzles. (→P.623)



Note

- If printing does not improve after **Head Cleaning A**, try **Head Cleaning B**. If this does not solve the problem, repeat **Head Cleaning B** two or three times. If this still does not improve printing, the Printhead may have reached the end of its useful life. Contact your Canon dealer.



Caution

- Do not remove the Maintenance Cartridge or Ink Tanks during cleaning.

Replacing the Printhead

When to replace the Printhead

This printer uses two Printheads.

Replace one or both Printheads in the following situations.

- If the printing quality does not improve even after two cycles of **Head Cleaning B** from the printer menu
Replace both Printheads, one at a time.
- If the Display Screen indicates **Open top cover and replace the left printhead.**
Replace the left Printhead.
- If the Display Screen indicates **Open top cover and replace the right printhead.**
Replace the right Printhead.
- If your Canon dealer has advised you to replace the Printhead
Replace the Printhead that your dealer advised you to replace.

Compatible Printhead

For information on the compatible Printhead, see “Printhead”. (→P.622)

Precautions when handling the Printhead

Take the following precautions when handling the Printhead.



Caution

- For safety, keep the Printhead in a place inaccessible for children.
- If ink is accidentally ingested, contact a physician immediately.
- Do not touch the Printhead immediately after printing. The Printhead becomes extremely hot, and there is a risk of burns.



Important

- Avoid dropping or shaking the Printhead. Otherwise, ink may leak and cause stains.
- There may be ink around the nozzles of the Printhead you remove. Handle the Printhead carefully during replacement. The ink may stain clothing.
- Do not open the Printhead pouch until immediately before installation. After removing the Printhead from the pouch, install it right away. If the Printhead is left after the pouch is opened, the nozzles may dry out, which may affect printing quality.
- If you need to store a Printhead temporarily before installation, do not keep the nozzles and metal contacts (→P.629) facing down. If the nozzles or metal contacts are damaged, it may affect the printing quality.
- Never attempt to take apart or modify a Printhead. This may damage the printer.
- Never touch the Printhead nozzles or the metal contacts. This may cause printing problems.

Replacing the Printhead

Follow the steps below to replace the Printhead. Failure to follow this procedure may cause ink leak from the Printhead, which may cause stains.



Note

- Prepare a new Ink Tank when ink levels are low.
- Your hands may become dirty during Printhead replacement. Use the gloves provided with the new Printhead for replacement.
- Choose **On** in **Auto Print** to have the printer automatically adjust the Printhead alignment after replacement of the Printhead. (→P.49)

1. If the roll is not ejected because of the cutting method selected, cut it manually and remove it. (→P.421)
2. Clean inside the Top Cover. (→P.640)
3. Press the **Menu** button to display **MAIN MENU**.

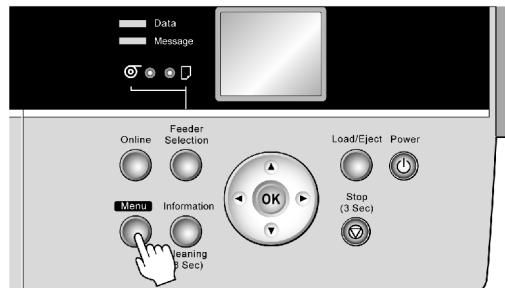

4. Press ▲ or ▼ to select **Maintenance**, and then press the ► button.
5. Press ▲ or ▼ to select **Replace P.head**, and then press the ► button.
6. Press ▲ or ▼ to select the Printhead for replacement, and then press the ► button.
7. Press ▲ or ▼ to select **Yes**, and then press the **OK** button.

Select **Printhead L** to replace the Printhead L or select **Printhead R** to replace the Printhead R. Be sure to specify the correct printhead.

Ink is now filled.

After about three minutes, a message is shown on the Display Screen instructing you to open the Top Cover.

8. Open the Top Cover.

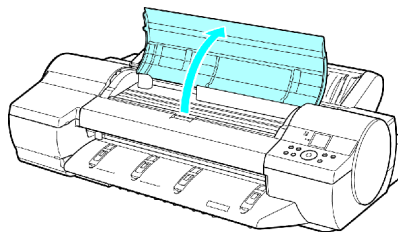

Instructions are now shown on the Display Screen regarding Printhead replacement.

- 9.** If the Printhead Fixer Cover or Printhead Fixer Lever is dirty, use a damp cloth that you have wrung out completely to wipe it clean.

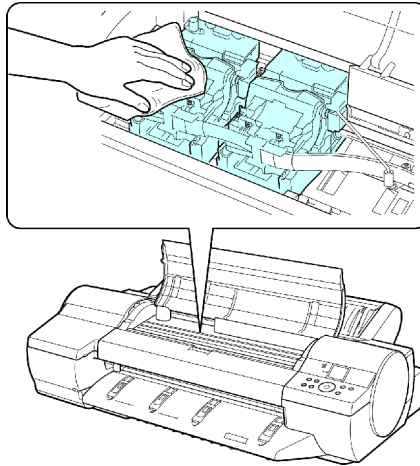

Important

- Never touch the Linear Scale (a) or Carriage Shaft (b).

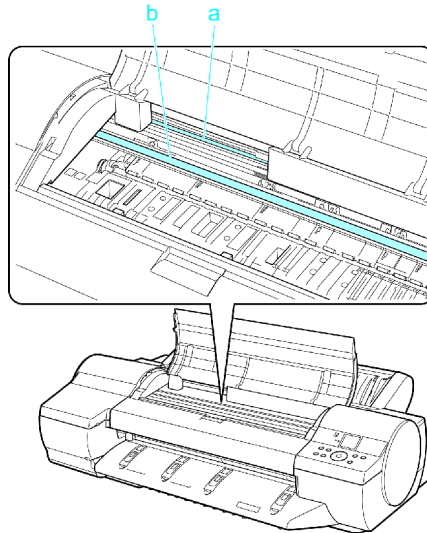

- Never touch the metal contacts of the Carriage. This may damage the printer.

- 10.** Pull the Printhead Fixer Lever forward all the way to open it completely.

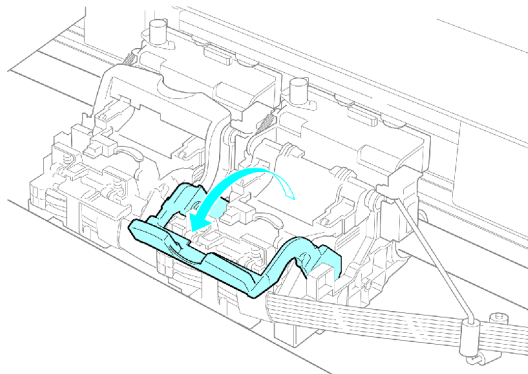

11. Pull up the Printhead Fixer Cover to open it completely.

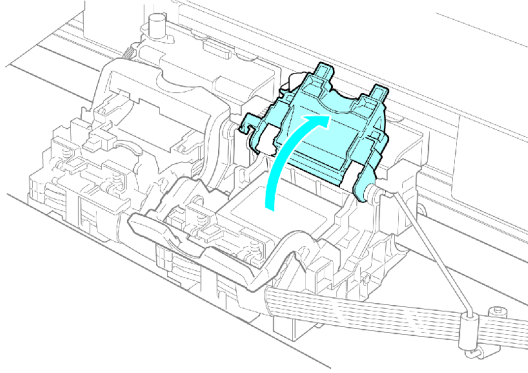

12. Remove the used Printhead.

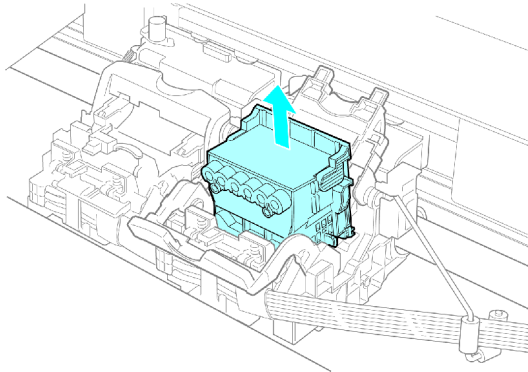

Caution

- When replacing the Printhead immediately after printing, wait a few minutes before replacing it. The metal parts of the Printhead become hot during printing, and there is a risk of burns from touching these parts.



Note

- Dispose of the used Printhead in accordance with local regulations.

13. Holding the new Printhead by the grips (a), remove it from the case.

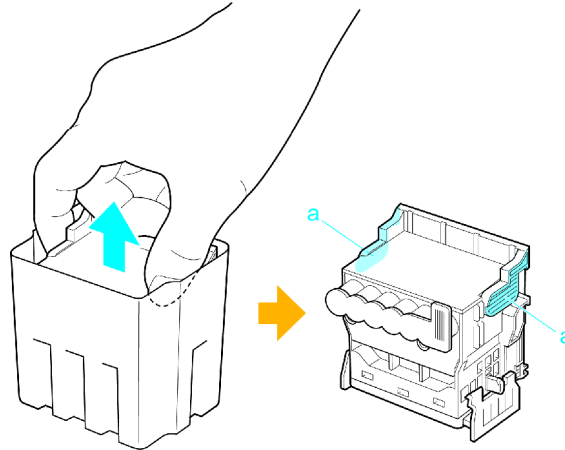

Important

- When handling the Printhead, always hold it by the grips (a). Never touch the nozzles (b) or the metal contacts (c). This may damage the Printhead and affect printing quality.

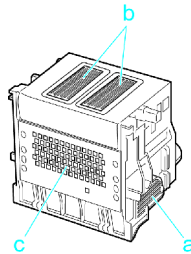

14. While firmly holding the Printhead you have removed, use your other hand to remove the orange Safety Cap 1 (a). Squeeze the grips (c) of Safety Cap 2 (b) and pull it down to remove it.

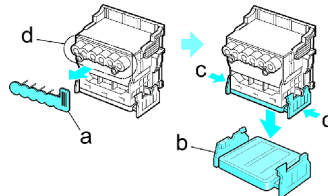

Important

- Safety Cap 1 (a) may be coated with ink to protect the Printhead. Be careful not to touch areas other than the grips.
- Never touch the ink supply section (d). This may cause printing problems.
- The inside surface of Safety Cap 2 (b) is coated with ink to protect the nozzles. Handle it carefully to avoid touching the nozzles or spilling ink. Spilled ink may cause stains. The Printhead contains ink to protect the nozzles. If this ink is accidentally spilled, it may stain the printer or surrounding area. We recommend removing the Safety Cap 2 (b) on top of the Printhead package or safely out of the way. Wipe off any spilled ink with a dry cloth. This ink is non-toxic.
- Do not reattach the Safety Cap or protective material. Dispose of these materials in accordance with local regulations.

15. With the nozzles facing down and the metal contacts toward the back, insert the Printhead into the Carriage. Making sure that the metal contacts do not touch the Carriage, carefully push the printhead firmly into the carriage.

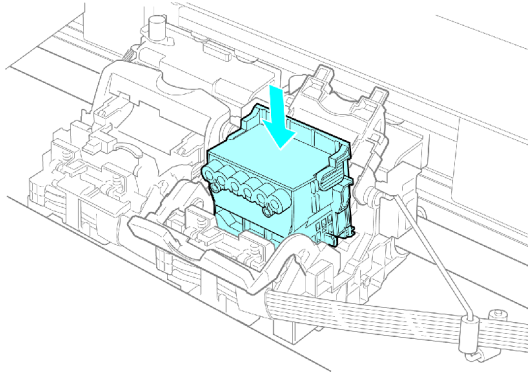

16. Pull the Printhead Fixer Cover down toward the front to lock the Printhead in place.

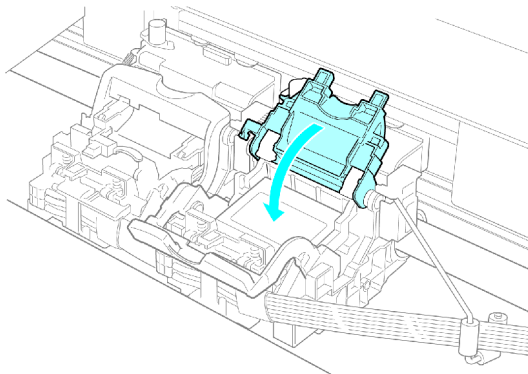

17. Push the Printhead Fixer Lever toward the back of the printer until it clicks.

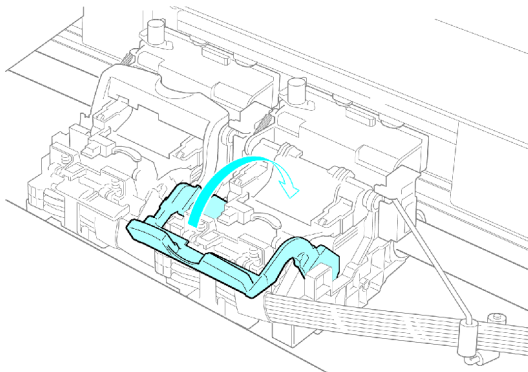

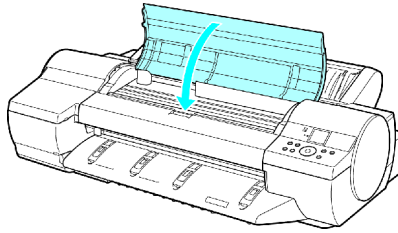
18. Close the Top Cover.

Ink now fills the system.

After about ten minutes, the Printhead alignment will be automatically adjusted, and the printer will go online.

If no paper has been loaded, a message is displayed requesting you to load paper.

**Important**

- Never remove an Ink Tank while the system is filling with ink.
- If **Auto Print** is **Off** in the printer menu, the Printhead alignment will not be adjusted. In this case, adjust the alignment after Printhead replacement by accessing **Auto Head Adj.** in **Advanced Adj.** (→P.584)

Maintenance Cartridge

☐ Maintenance Cartridge

This is a replacement Maintenance Cartridge for the printer.

- Maintenance Cartridge MC-16

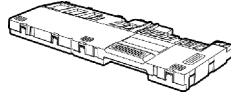

Note

- For instructions on replacing the Maintenance Cartridge, see “Replacing the Maintenance Cartridge”. (→P.632)

☐ Replacing the Maintenance Cartridge

Compatible Maintenance Cartridge

For information on the compatible Maintenance Cartridge, see “Maintenance Cartridge”. (→P.632)

Precautions when handling the Maintenance Cartridge

Take the following precautions when handling the Maintenance Cartridge.



Caution

- For safety, keep the Maintenance Cartridge out of the reach of children.
- If ink is accidentally ingested, contact a physician immediately.



Important

- Do not remove the Maintenance Cartridge except to replace it.
- To prevent ink from leaking from a used Maintenance Cartridge, avoid dropping the cartridge or storing it at an angle. Otherwise, ink may leak and cause stains.
- Ink adheres to the top of the Maintenance Cartridge after it has been used. Handle the Maintenance Cartridge carefully during replacement. The ink may stain clothing.
- Do not install a used Maintenance Cartridge in another printer.

Replacing the Maintenance Cartridge

1. Make sure no print jobs are in progress.

You can replace the Maintenance Cartridge if the Display Screen indicates the printer is **Offline** or if messages advise you to replace the Maintenance Cartridge.

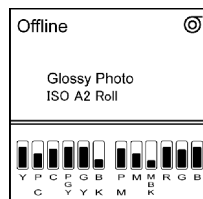

If a message prompts you to replace the Maintenance Cartridge, press the **OK** button. Steps 2 and 3 are unnecessary in this case. Go to step 4 and remove the Maintenance Cartridge.

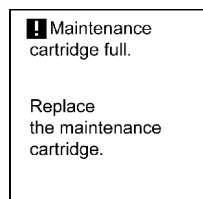

Do not replace the Maintenance Cartridge during initialization immediately after turning on the printer, during Printhead cleaning, or while ink is being filled.

If you pause printing to replace the Maintenance Cartridge, it may cause the printed images to be blurry.

2. Press the **Menu** button to display **MAIN MENU**.

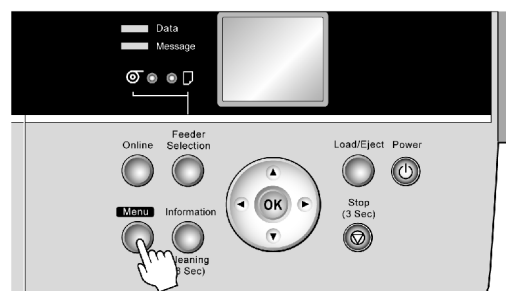

3. Press **▲** or **▼** to select **Maintenance**, and then press the **▶** button.
4. Press **▲** or **▼** to select **Repl. maint cart**, and then press the **▶** button.
5. Press **▲** or **▼** to select **Yes**, and then press the **OK** button.
6. Remove the Ejection Guide.

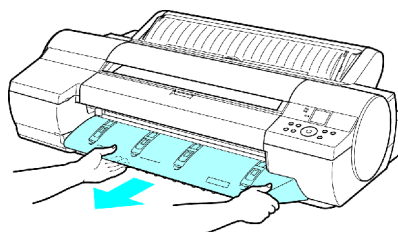

7. Hold the handle (a) of the used Maintenance Cartridge and pull out the cartridge. Grasp the handles on both sides (b) and keep the cartridge level as you remove it.

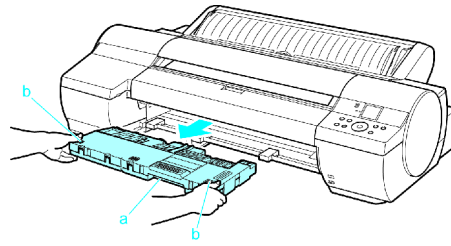

Important

- Used Maintenance Cartridge is heavy. Always grasp the cartridge handles on both sides firmly and keep the cartridge level during removal and storage. If you drop a used Maintenance Cartridge or store it at an angle, ink may leak and cause stains.
- The remaining Maintenance Cartridge capacity is recorded on each printer. Do not install a used Maintenance Cartridge in another printer.

8. Open the plastic bag of the new Maintenance Cartridge and remove the packaging material. Holding the handles on both sides (a), remove the cartridge.

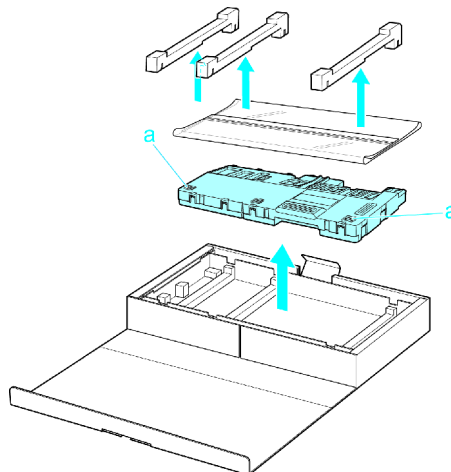

Important

- Never touch the metal contacts (a). This may damage the Maintenance Cartridge.

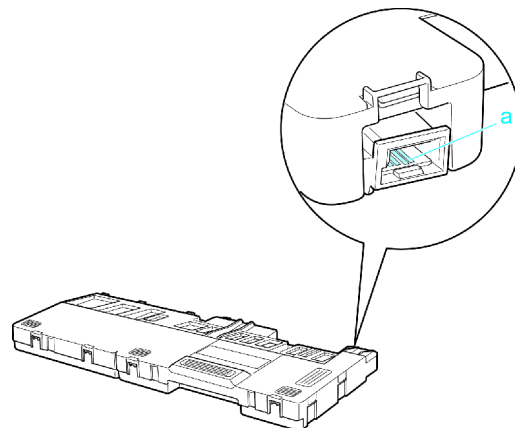

- 9.** Keeping the used Maintenance Cartridge level, put it in the plastic bag that was in the box, as shown.

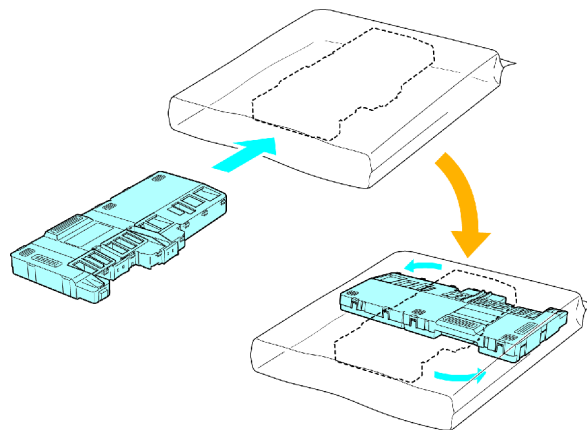

- 10.** Expel air in the plastic bag and seal the zipper. Fold the plastic bag in half.

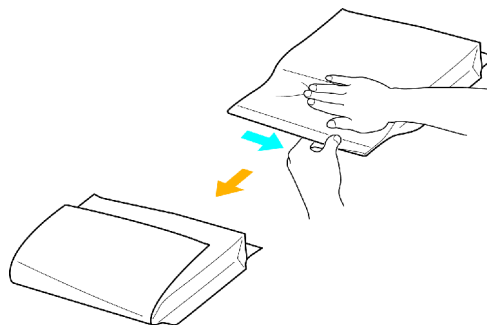

- 11.** Put the used Maintenance Cartridge and packaging material in the box for storage, just like the new Maintenance Cartridge was, keeping it level.

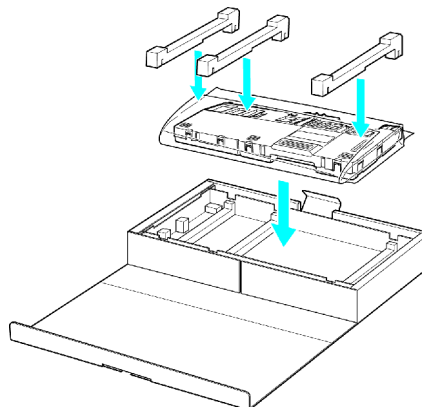

Important

- Always put the used Maintenance Cartridge back in the box and store the box on a flat surface. Otherwise, ink may leak and cause stains.
- In accordance with its active and ongoing policy to protect the environment, Canon collects used Maintenance Cartridge. Follow the instructions provided with the new Maintenance Cartridge that describe how to process the used Maintenance Cartridge.

12. Holding the handles on both sides of the new Maintenance Cartridge (a), insert it completely, keeping it level.

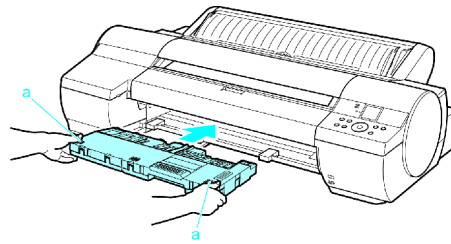

13. Hold the Ejection Guide on both sides by the near end. Aligning the Ejection Guide with the guides (a), insert it into the printer until it locks in place.

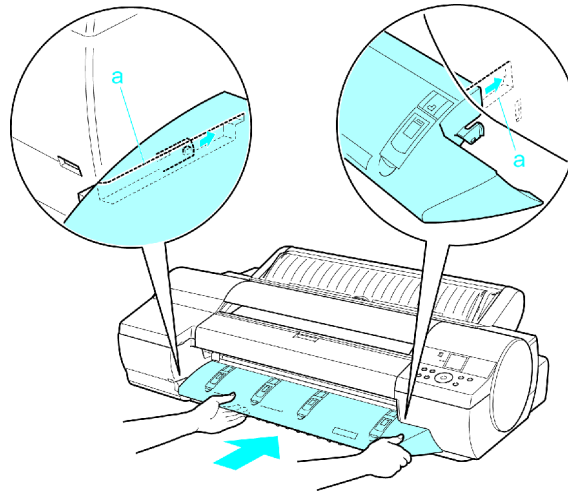

14. Press the **OK** button.

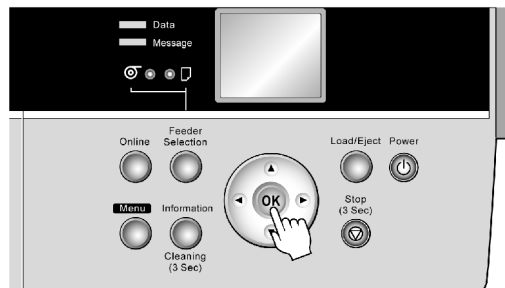

The printer returns to the mode before replacement of the Maintenance Cartridge. If a message is displayed advising you to replace the Maintenance Cartridge, printing is not possible. Make sure that the Maintenance Cartridge is installed correctly. If a print job was in progress when the Maintenance Cartridge was replaced, printing is resumed.



Important

- Do not remove the Maintenance Cartridge during about the first five seconds after the printer goes back online. This may damage the Maintenance Cartridge.
- If you replace the Maintenance Cartridge when the printer is off, do not remove the Maintenance Cartridge during about the first five seconds after you turn the printer on again after replacement. This may damage the Maintenance Cartridge.

☐☐☐ Checking the Remaining Maintenance Cartridge Capacity

The Maintenance Cartridge absorbs excess ink from borderless printing, printhead cleaning, and other processes. You can confirm the remaining capacity of the Maintenance Cartridge by checking the Maintenance Cartridge capacity shown on the Display Screen.

Press the **Information** button to display the remaining capacity of the Maintenance Cartridge on the Display Screen.

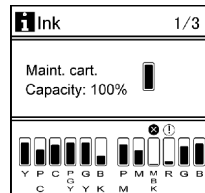

If the Display Screen indicates to replace the Maintenance Cartridge, replace the Maintenance Cartridge. If a message is displayed indicating to check the remaining capacity of the Maintenance Cartridge, or before tasks that deplete much of the capacity such as head cleaning or preparations to move the printer, check the remaining Maintenance Cartridge capacity and replace the Maintenance Cartridge as needed. (→P.632)

☐ When to Replace the Maintenance Cartridge

Replace or prepare to replace the Maintenance Cartridge in the following situations.

If a message for checking the Maintenance Cartridge is shown on the Display Screen

When the Maintenance Cartridge capacity is low, the **Message lamp** is lit and **Prepare for maint cart replacement.** is displayed. You can continue to print, but check the remaining Maintenance Cartridge capacity and prepare to replace the Maintenance Cartridge with a new one. (→P.637)

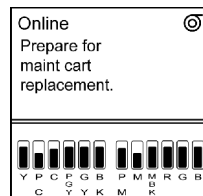

When much of the Maintenance Cartridge capacity is depleted

Printhead cleaning, Printhead replacement, and preparations to transfer the printer deplete much of the Maintenance Cartridge capacity. (In particular, preparing to move the printer depletes a lot of the capacity.) To check the remaining Maintenance Cartridge capacity, press the **Information** button. Replace the Maintenance Cartridge and perform related maintenance as needed.

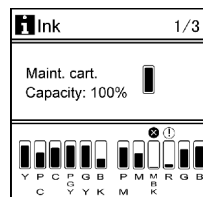

If a message for the Maintenance Cartridge replacement is shown on the Display Screen

When the Maintenance Cartridge is full, the **Message lamp** flashes and a message to replace the Maintenance Cartridge is shown on the Display Screen. Printing is disabled, and you cannot replace the Printhead or transfer the printer. Replace the Maintenance Cartridge with a new one.

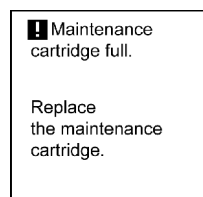

Cleaning the Printer

☐ Cleaning the Printer Exterior

Clean the printer regularly to maintain better printing quality and help prevent problems.

About once a month, clean the printer exterior.

1. Turn the printer off. (→P.19)
2. Unplug the power cord from the outlet.

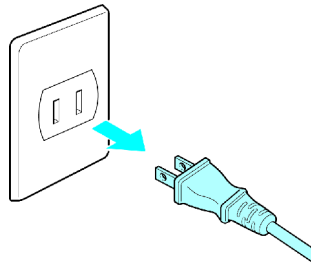

Caution

- Always turn off the printer and unplug the power cord before cleaning or maintenance. Accidentally leaving the printer on poses a risk of injury if you touch moving parts inside the printer.

3. Using a damp cloth that you have wrung out completely, wipe the exterior surfaces of the printer. Dry the surfaces with a dry cloth.

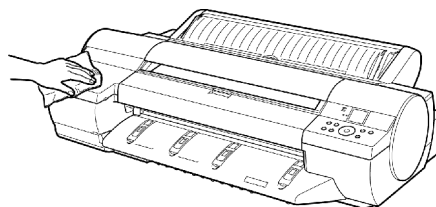

Caution

- Never use flammable solvents such as alcohol, benzene, or thinner. If these substances come into contact with electrical components inside the printer, there is a risk of fire or electrical shock.



Important

- If the Ejection Guide is dirty, it may soil the edge of the paper when the paper is cut. We recommend cleaning the Ejection Guide even if it does not appear dirty, because it may actually be covered with paper dust.

4. Plug the power cord into the outlet.

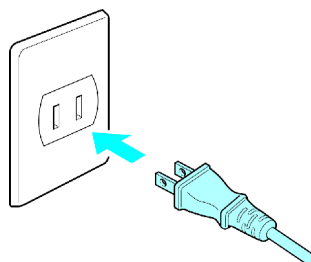

■ ■ ■ Cleaning Inside the Top Cover

Clean inside the Top Cover about once a month to maintain better printing quality and help prevent problems. Also clean inside the Top Cover in the following situations to ensure optimal operation.

- If the printed surface or the underside of paper is dirty after printing
- After you have used up a roll
- After borderless printing
- After printing on small paper
- After printing on paper that generates a lot of cutting debris
- If you have replaced the roll
- After printing on paper that generates a lot of paper dust



Important

- If the Platen inside the Top Cover becomes dirty, it may soil the underside of paper. We recommend always cleaning the Platen after borderless printing or printing on small paper.
- If the Ejection Guide is dirty, it may soil the edge of the paper when the paper is cut. We recommend cleaning the Ejection Guide even if it does not appear dirty, because it may actually be covered with paper dust.

1. Press the **Menu** button to display **MAIN MENU**.

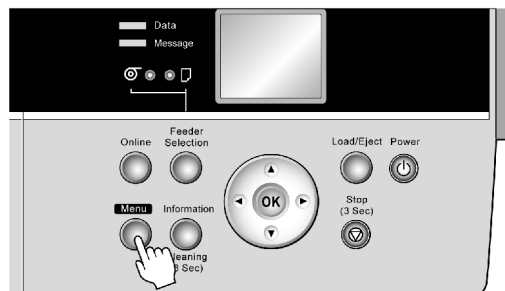

2. Press ▲ or ▼ to select **Maintenance**, and then press the ► button.
3. Press ▲ or ▼ to select **Clean Platen**, and then press the ► button.
4. Press ▲ or ▼ to select **Yes**, and then press the **OK** button.
5. Open the Top Cover.

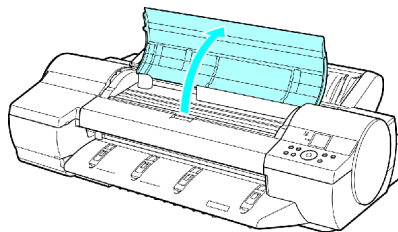

6. If paper dust has accumulated in the Vacuum holes (a) on the Platen or in the Borderless Printing Ink Grooves (b), use the Cleaning Brush, provided with the printer, to wipe it away.

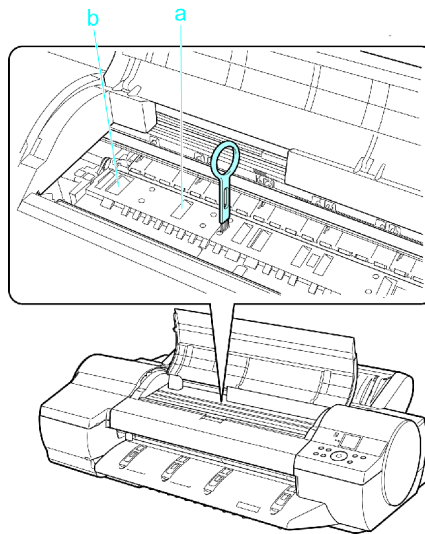
**Note**

- If the Cleaning Brush is dirty, rinse it in water.

7. Using a damp cloth that you have wrung out completely, wipe inside the Top Cover to clean it. Wipe away any ink residue on the Platen as a whole, the Paper Retainer, and the Borderless Printing Ink Grooves.

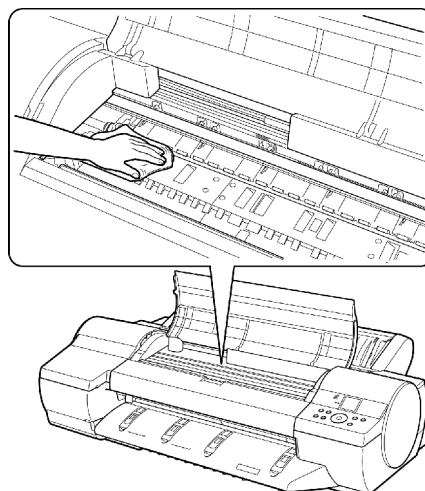



Important

- Do not use a dry cloth to wipe inside the Top Cover. This may create a static charge, which may attract dust and affect the printing quality.
- Never use flammable solvents such as alcohol, benzene, or thinner. If these substances come into contact with electrical components inside the printer, there is a risk of fire or electrical shock.
- Never touch the Linear Scale (a) or Carriage Shaft (b).

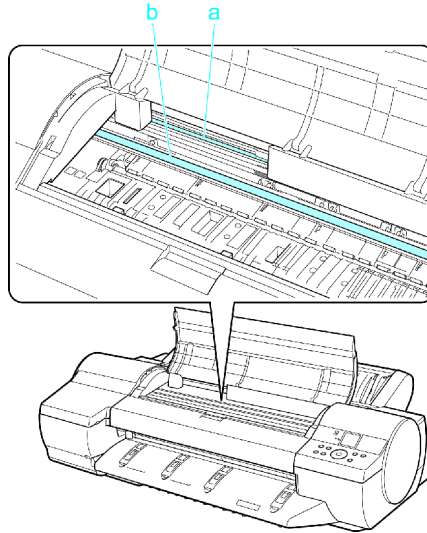

8. Close the Top Cover.

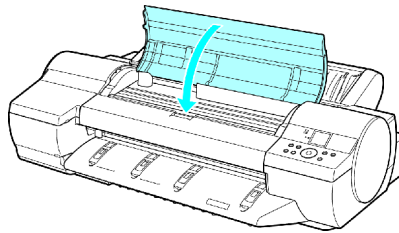

☐ Cleaning the Paper Retainer

Clean the Paper Retainer about once a month to maintain better printing quality and help prevent problems. Also clean the Paper Retainer in the following situations to ensure the printer offers a comfortable working environment.

- If the printed surface or the underside of paper is dirty after printing
- After printing on small paper



Caution

- During cleaning, use a type of paper that does not generate much dust from cutting, such as Plain Paper. It may affect printing quality if you use film or other media that are more likely to generate debris when cut, or that have a surface finish that may come off.

1. Turn the printer off. (→P.19)
2. Unplug the power cord from the outlet.

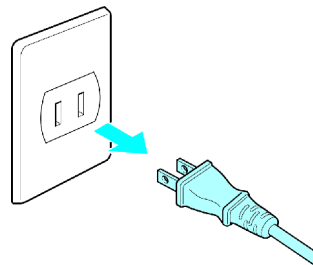

Caution

- Always turn off the printer and unplug the power cord before cleaning and maintenance. Accidentally leaving the printer on poses a risk of injury if you touch moving parts inside the printer.

3. Remove the Roll Feed Unit. (→P.147)
4. Fold a sheet of Plain Paper two or three times (a) and insert it under the Paper Retainer (b) behind the printer to wipe the entire surface of the Paper Retainer clean.

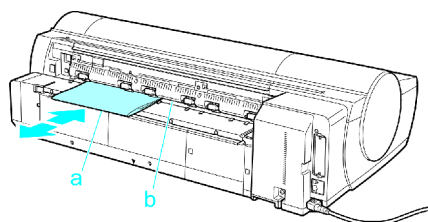

5. Reinstall the Roll Feed Unit. (→P.148)
6. Plug the power cord into the outlet.

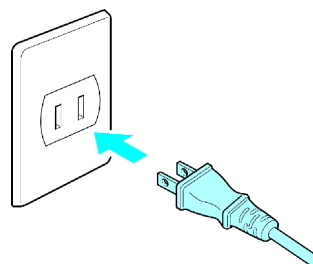

Cleaning Spurs Used in Paper Feeding

If white dots about 1 mm (0.039 in) apart appear on printed documents in the direction paper is fed, clean the spurs.

During spur cleaning, a Cleaning sheet fed from the Top Paper Feed Slot is repeatedly advanced and retracted to clean the spurs (a).

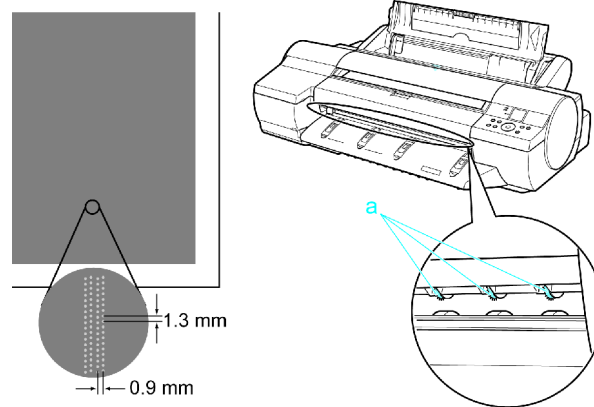

Note

- Use the provided Cleaning sheet for spur cleaning.
- If the spurs are quite soiled, executing cleaning once may not be enough to clean them completely. Execute cleaning again if one time is not effective.
- If a roll is loaded, rewind the roll before this procedure. (→P.146)



Important

- Do not fold the Cleaning sheet.
- Do not use a frayed Cleaning sheet or Cleaning sheet that has become very dirty.
- If the Cleaning sheet is warped, straighten it before use.
- To cancel cleaning, press the **Stop** button.

1. Press the **Menu** button to display **MAIN MENU**.

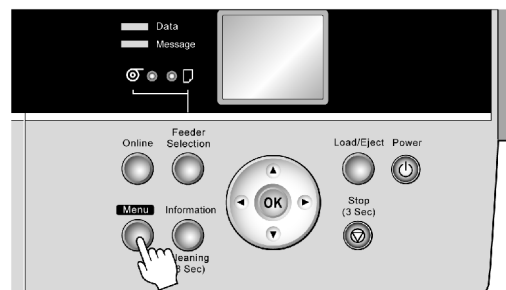

2. Press **▲** or **▼** to select **Maintenance**, and then press the **▶** button.

3. Press **▲** or **▼** to select **Spur Cleaning**, and then press the **▶** button.

4. Press **▲** or **▼** to select **Yes**, and then press the **OK** button.

- 5.** Open the Paper Tray Cover (a).

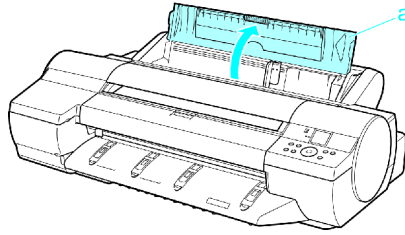

- 6.** Squeeze the Width Guide (a) and slide it all the way to the left.

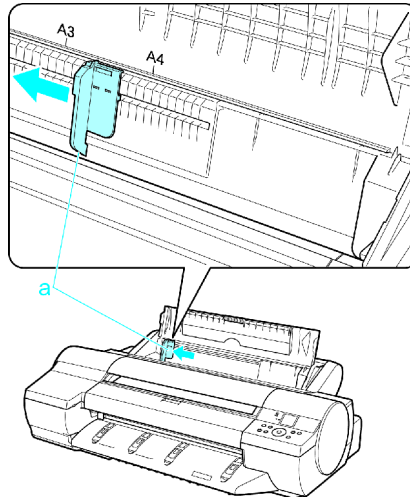

- 7.** Remove the Cleaning sheet from the pouch.
The pouch is used to store the Cleaning Sheet, so keep it in a safe place.
- 8.** Insert the long side of the Cleaning sheet in the Top Paper Feed Slot in the position to be cleaned.
Insert the Cleaning sheet gently until it stops.

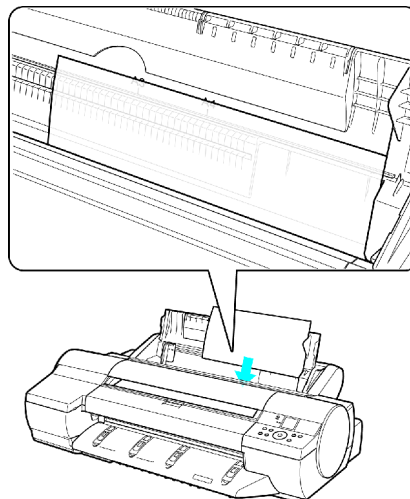

Cleaning the Printer



Note

- If the width of the paper used when soiling occurred is wider than the Cleaning sheet, insert the sheet in different positions as you perform cleaning.

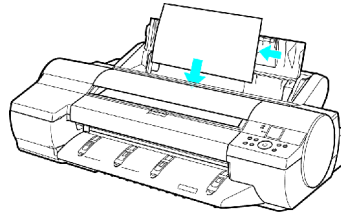

9. Press the **OK** button to start cleaning.

Cleaning takes about a minute and a half.

10. **Pull out the cleaning sheet and press OK.** is shown on the Control Panel. At this point, pull out the Cleaning sheet and press the **OK** button.

11. Put the Cleaning Sheet back in the pouch.

12. Close the Paper Tray Cover (a).

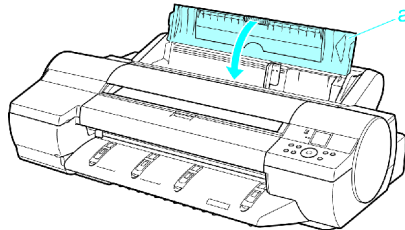

Cleaning the Printhead

Cleaning the Printhead may help clear nozzles that are clogged.



Note

- You can specify a number of pages in the printer's **Noz. Check Freq.** menu for automatic nozzle checking and cleaning every time you finish printing that quantity. (→P.49)
- You can start **Head Cleaning A** by holding down the **Information** button for three seconds or more.
- Printhead cleaning is not possible if POP Board (1.5 mm [0.06 in] thick) is loaded in the Front Paper Feed Slot. Remove the paper before cleaning.

Cleaning the Printhead

1. Press the **Menu** button to display **MAIN MENU**.

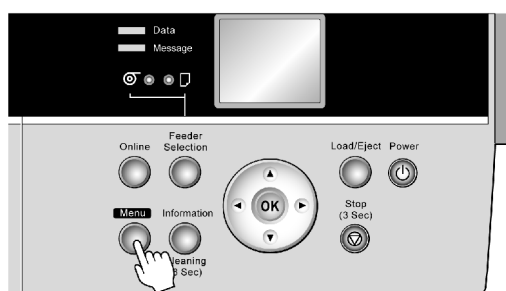

2. Press **▲** or **▼** to select **Head Cleaning**, and then press the **▶** button.
3. Press **▲** or **▼** to select the type of cleaning, and then press the **OK** button.

- **Head Cleaning A**

Use **Head Cleaning A** if printing is faint or contains foreign substances. This method of cleaning consumes the least amount of ink. It takes about four minutes to complete.

- **Head Cleaning B**

Use **Head Cleaning B** if no ink comes out of the printhead, or if **Head Cleaning A** does not solve the problem. It takes about five minutes to complete.

The printhead is cleaned, and the printer goes online.

4. Print a test pattern to check the nozzles, and determine whether cleaning has cleared the nozzles. (→P.623)



Note

- If printing does not improve after **Head Cleaning A**, try **Head Cleaning B**. If this does not solve the problem, repeat **Head Cleaning B** two or three times. If this still does not improve printing, the Printhead may have reached the end of its useful life. Contact your Canon dealer.



Caution

- Do not remove the Maintenance Cartridge or Ink Tanks during cleaning.

Other Maintenance

Preparing to Transfer the Printer

To protect the internal parts in transit, always follow the steps below before transferring the printer to a new location. Refer to the Quick Start Guide for details on packing the printer and installing it after transfer.



Note

- It is not possible to prepare the printer for transfer if the Display Screen prompts you to replace the Maintenance Cartridge or check the remaining capacity. Replace the Maintenance Cartridge before transfer preparations. (→P.632)
- Do not tilt the printer in transit. Ink inside the printer may leak and cause stains. If it is necessary to stand the printer up or tilt it, contact your Canon dealer.

1. Remove the paper.

- Rolls
 1. Removing Rolls from the Roll Feed Unit (→P.122)
 2. Removing Rolls From the Roll Holder (→P.118)
- Sheet
 1. Removing Sheets from the Top Paper Feed Slot (→P.164)
 2. Removing Heavyweight Paper from the Front Paper Feed Slot (→P.165)

2. Press the **Menu** button to display **MAIN MENU**.

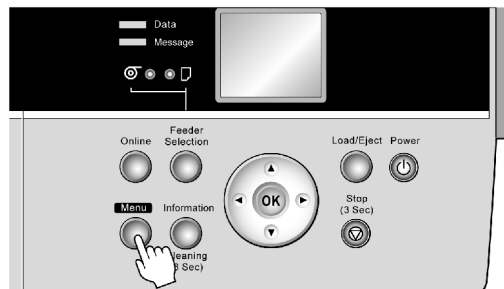

3. Press ▲ or ▼ to select **Maintenance**, and then press the ► button.

4. Press ▲ or ▼ to select **Move Printer**, and then press the ► button.

5. Press ▲ or ▼ to select **Yes**, and then press the **OK** button.

The printer now starts preparing for transfer.

If a message is shown on the Display Screen requesting you to open the Ink Tank Cover, follow the procedure starting with step 6.

6. Open the Ink Tank Cover.

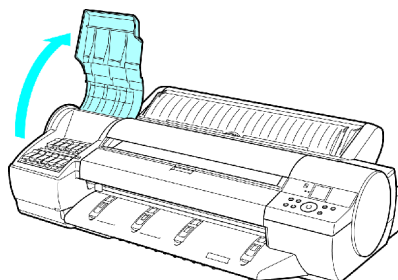

7. Open the Ink Tank Lock Lever and remove every Ink Tank.

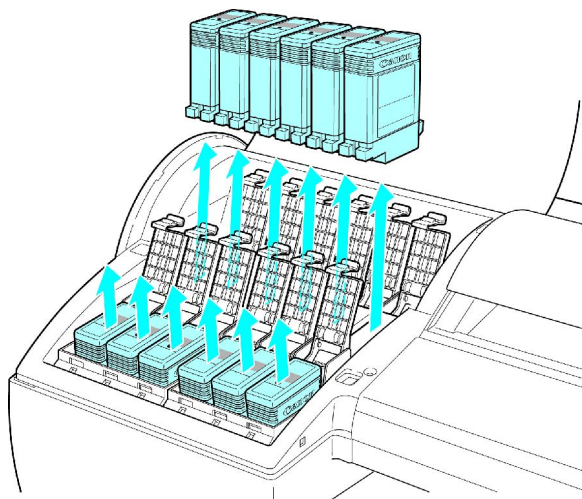

Put the Ink Tank in a plastic bag and seal it.



Note

- Store the Ink Tank you removed with the ink holes (a) facing up. Otherwise, ink may leak and cause stains.

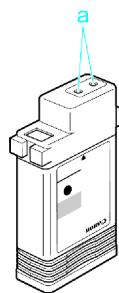

8. Close every Ink Tank Lock Lever, and close the Ink Tank Cover.

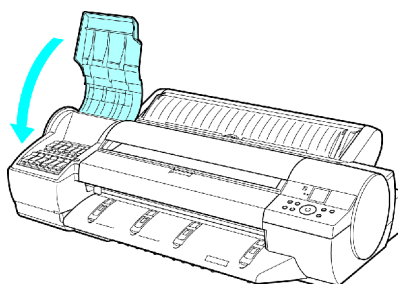

At this point, ink is drawn out from inside the tubes.



Important

- Do not remove the Maintenance Cartridge during this process.

When the suction is finished, **Turn Power Off!!** is displayed.

9. Press the **Power** button and turn off the printer.



Important

- Turn off the printer before you unplug it. It may damage the printer if you unplug it before it is off and transfer it in that state. If you accidentally unplug the printer, plug it in again, reinstall the Ink Tanks, wait until the printer comes online, and follow this procedure again.

10. Disconnect the power cord and interface cable.

11. Open the Top Cover.

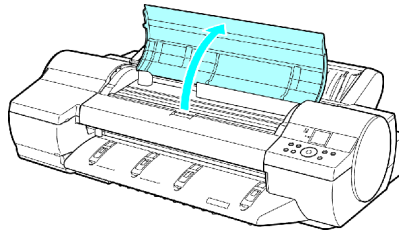

12. Grasp the Belt, insert it between the Belt Stopper, and affix the Belt Stopper to the Carriage Shaft.

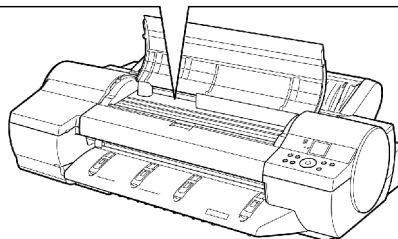
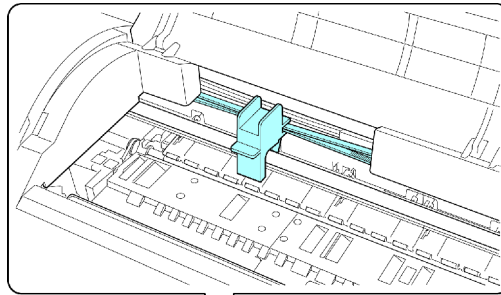

**Important**

- Never touch the Linear Scale (a) or Carriage Shaft (b).

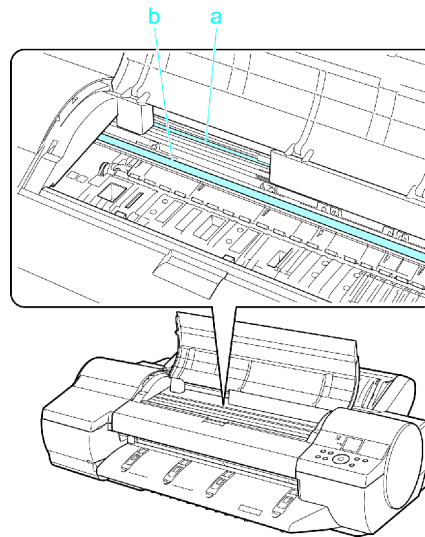
**Note**

- Here, the Belt Stopper is the one that was removed and stored after initial installation.

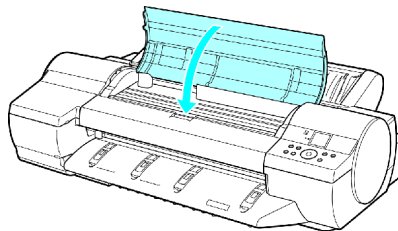
13. Close the Top Cover.**14.** Tape down printer covers to secure them, in the reverse order of tape removal during installation.**15.** Repack the Roll Holder, Holder Stopper, and printer in shipping materials, and then package them in a shipping box.

Updating the Firmware

Update the printer firmware to take advantage of new and improved printer functions.

Confirming the firmware version

1. Press the **Menu** button to display **MAIN MENU**.

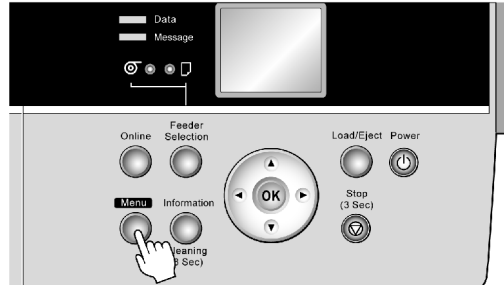

2. Press ▲ or ▼ to select **Information**, and then press ►.
3. Press ▲ or ▼ to select **System Info**, and then press the ► button.
The firmware version is displayed.

Updating the firmware

To obtain the latest firmware, visit the Canon website. If the firmware available online is newer than the installed firmware, update the printer firmware. For details on downloading and updating the firmware, visit the Canon website.

Troubleshooting

Frequently Asked Questions

☐☐☐ Frequently Asked Questions

This section presents frequently asked questions and answers. To view more detailed explanations, click the hyperlinks in the answer column.

Question	Answer
How do I print on a roll?	When printing on rolls, after loading the roll, specify the paper type and length, both on the Control Panel and in the printer driver. ⇒Loading and Printing on Rolls (→P.80)
How do I print manually?	When printing manually, specify the paper type and size in the printer driver, and then load the paper. ⇒Loading and Printing on Sheets in the Paper Feed Slot (→P.85)
How do I switch between printing on a roll and printing manually?	Press the Feeder Selection button to switch the paper source between the roll and a sheet. ⇒Selecting the Roll as the Paper Source (→P.115) ⇒Selecting the Sheet as the Paper Source (→P.154)
How do I change the paper type or size?	Specify the type and size of paper, both on the Control Panel and in the printer driver. <ul style="list-style-type: none"> • Specifying it in the Printer Driver ⇒Specifying Paper in the Printer Driver (→P.655) • Specifying it on the Control Panel <ul style="list-style-type: none"> Selecting the paper type ⇒Selecting the Paper Type (Roll) (→P.124) ⇒Selecting the Paper Type (Sheet) (→P.162) Selecting the Paper Size ⇒Specifying the Paper Length (Roll) (→P.125) ⇒Selecting the Paper Size (Sheet) (→P.163)
How do I cut the roll paper after printing?	You can wait until ink dries before cutting the roll, and you can cut rolls at a desired position. ⇒Specifying the Cutting Method for Rolls (→P.129)
How do I print without borders?	Borderless printing is possible on rolls. You can also specify borderless printing in the printer driver by adjusting the original size to match the paper size. Borderless printing is not supported on sheets. ⇒Borderless Printing on Paper of Equivalent Size (→P.297) ⇒Borderless Printing by Resizing Originals to Fit the Roll Width (→P.299) ⇒Borderless Printing at Actual Size (→P.279)

Frequently Asked Questions

Question	Answer
How do I print an A4 original enlarged on A2 paper?	<p>In the printer driver, you can adjust the original image to match the paper size or width, or you can specify enlargement or reduction before printing as desired.</p> <ul style="list-style-type: none"> ⇒Resizing Originals to Match the Paper Size (→P.244) ⇒Resizing Originals to Fit the Roll Width (→P.245) ⇒Resizing Originals by Entering a Scaling Value (→P.246)
How do I print without wasting paper?	<p>To conserve paper, you can specify in the printer driver to rotate originals 90 degrees or to print without top and bottom margins.</p> <ul style="list-style-type: none"> ⇒Conserving Roll Paper by Rotating Originals 90 Degrees (→P.395) ⇒Conserving Roll Paper by Printing Originals Without Top and Bottom Margins (→P.396)
How do I print without wasting all the blank space on the right side when printing an A4-sized original at A3 size?	<p>By specifying to rotate originals 90 degrees in the printer driver, you can print at A4 size to fill the width of A3 paper.</p> <ul style="list-style-type: none"> ⇒Conserving Roll Paper by Rotating Originals 90 Degrees (→P.395)
How do I print in landscape (or portrait) orientation?	<p>You can print originals that are in landscape (or portrait) orientation automatically enlarged to fit the roll width. This is an easy way to create vertical or horizontal banners.</p> <ul style="list-style-type: none"> ⇒Printing Vertical or Horizontal Banners (Large-Format Printing) (→P.330)
How do I print on a custom paper size?	<p>You can specify custom sizes temporarily in the printer driver.</p> <ul style="list-style-type: none"> ⇒Printing on Non-Standard Paper Sizes (→P.331)
How do I register custom paper sizes?	<p>You can add desired sizes (Custom Media Sizes) in the Size Options dialog box of the printer driver.</p> <ul style="list-style-type: none"> ⇒Printing on Non-Standard Paper Sizes (→P.331)
How do I print lines thicker?	<p>By specifying Thicken Fine Lines in the printer driver, you can print fine lines thicker to make them easier to see.</p> <ul style="list-style-type: none"> ⇒Giving Priority to Particular Graphic Elements and Colors for Printing (→P.173)
How do I modify how colors are printed?	<p>To compensate for changes in color from individual variation among Printheads or from the printing environment and to ensure better color consistency, execute color calibration.</p> <ul style="list-style-type: none"> ⇒Using Color Calibration to Adjust Colors (→P.600) <p>You can adjust colors even further in the printer driver before printing.</p> <ul style="list-style-type: none"> ⇒Adjusting the Color in the Printer Driver (→P.184)
How do I use printer driver settings again in subsequent jobs?	<p>By saving settings information in a favorite, you can apply the settings again before printing anytime as needed.</p> <ul style="list-style-type: none"> ⇒Using Favorites (→P.421)

Question	Answer
How do I use the printer in combination with a Color imageRUNNER ?	The printer can be used for automatic enlargement and printing of scanned originals from a Color imageRUNNER . ⇒Printing Enlargements of Scanned Originals from a Color imageRUNNER (→P.247)
How do I print enlargements of scanned originals from a Color imageRUNNER ?	By using Color imageRUNNER Enlargement Copy (iR enlargement copy), you can automatically print enlargements of scanned originals from a Color imageRUNNER . ⇒Printing Enlargements of Scanned Originals from a Color imageRUNNER (→P.247)

☐☐☐ Specifying Paper in the Printer Driver

If you replace the paper, complete the printer driver settings for the paper type and size.

For instructions on configuring paper settings in the printer driver, refer to the following topics, as appropriate for your computer and operating system.

- Specifying Paper in the Printer Driver (Windows) (→P.93)
- Specifying Paper in the Printer Driver (Mac OS X) (→P.95)
- Specifying Paper in the Printer Driver (Mac OS 9) (→P.97)

Printing does not start

☐ The Data lamp on the Control Panel does not light up

Cause	Corrective Action
The printer is not on.	Make sure the power cord is securely plugged in, all the way. Press the Power button to turn the printer on.
The printer is not selected in the printer driver. (The printer is in Sleep mode.)	In Windows, select the printer by clicking Select Printer or Printer in the printing dialog box and try printing again.
	In Mac OS X, select the printer by clicking Printer Setup Utility (or Print Center) and try printing again.
	In Mac OS 9, select the printer in Chooser and try printing again.
The print job is paused. (The printer is in Sleep mode.)	In Windows, restart the print job as follows. <ol style="list-style-type: none"> 1. Select the printer icon in the Printers and Faxes (or Printers) window. 2. Clear Pause Printing in the File menu to restart the print job.
	In Mac OS X, restart the print job as follows. <ol style="list-style-type: none"> 1. Open the Printer Setup Utility (or the Print Center). 2. Select the printer, and then Start Jobs in the Printers menu to restart the print job.
	In Mac OS 9, restart the print job as follows. <ol style="list-style-type: none"> 1. Open imagePROGRAF Printmonitor . 2. Choose Resume Printing in the File menu to restart the print job.

☐ The Printer Does Not Respond Even if Print Jobs are Sent

Cause	Corrective Action
The printer is offline.	Press the Online button on the Control Panel to bring the printer online.

☐ The Display Screen indicates the system is filling with ink

Cause	Corrective Action
When the printer was turned off previously, some cleaning operation was terminated.	Wait until the system has been filled with ink. This process may take about ten minutes.

Cannot print over a network

Cannot connect the printer to the network

Cause	Corrective Action
<p>The Ethernet cable is not connected correctly to the printer's Ethernet port.</p>	<ol style="list-style-type: none"> 1. Make sure the printer is connected to the network with the correct Ethernet cable, and then turn the printer on. For instructions on connecting the cable, refer to the Quick Start Guide . 2. Make sure the Link indicator is lit. The Link indicator is green if the printer is connected via 100 Base-TX and orange if connected via 10Base-T. If the Link indicator is not lit, check the following points. <ul style="list-style-type: none"> • Make sure the hub is on. • Make sure the end of the Ethernet cable is connected correctly. Insert the Ethernet cable until it clicks and locks in place. • Make sure there is no problem with the Ethernet cable. If there is any problem, replace the Ethernet cable. • Check the communication mode with the hub. Although the printer normally detects the hub communication mode and transmission rate automatically (in auto negotiation mode), sometimes the hub settings cannot be detected. In this case, configure the connection method manually, specifying the communication mode in use. (→P.658)

Configuring the Communication Mode Manually

This topic gives instructions for configuring the communication mode manually.

1. Press the **Menu** button to display **MAIN MENU**.

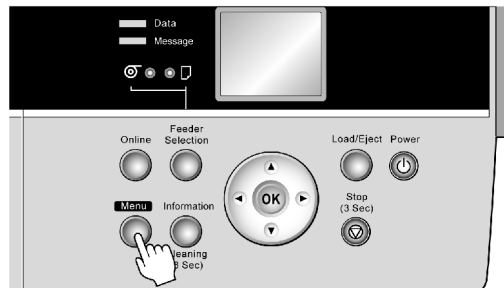

2. Press ▲ or ▼ to select **Interface Setup**, and then press ►.
3. Press ▲ or ▼ to select **Ethernet Driver**, and then press ►.
4. Press ▲ or ▼ to select **Auto Detect**, and then press ►.
5. Press ▲ or ▼ to select **Off**, and then press **OK**.
Return to the **Ethernet Driver** menu.
6. Press ▲ or ▼ to select **Comm.Mode**, and then press ►.
7. Press ▲ or ▼ to select the communication mode, and then press the **OK** button.
Return to the **Ethernet Driver** menu.
8. Press ▲ or ▼ to select **Ethernet Type**, and then press ►.
9. Press ▲ or ▼ to select the Ethernet type, and then press **OK**.
Return to the **Ethernet Driver** menu.
10. Press ▲ or ▼ to select **Spanning Tree**, and then press ►.
11. Press ▲ or ▼ to enable or disable spanning tree support, and then press **OK**.
Return to the **Ethernet Driver** menu.
12. Press the **Online** button.
After the confirmation message is displayed, press **OK**.
The printer will now restart.

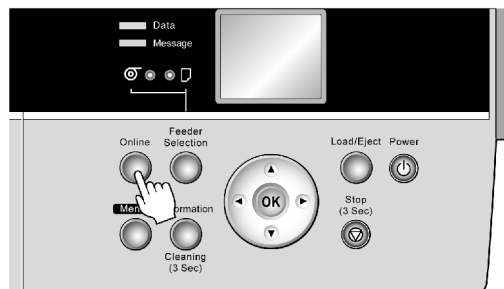

Cannot print over a TCP/IP network

Cause	Corrective Action
The printer's IP address is not configured correctly.	Make sure the printer's IP address is configured correctly. For details, see "Configuring the IP Address Using imagePROGRAF Device Setup Utility". (→P.471) or see "Configuring the IP Address Using the Printer Control Panel". (→P.551)
The printer's TCP/IP network settings are not configured correctly.	Make sure the printer's TCP/IP network settings are configured correctly. For details, see "Configuring the Printer's TCP/IP Network Settings". (→P.549)
The computer you are trying to print from is not configured correctly.	Make sure the computer's TCP/IP network settings are configured correctly. For details, see "Configuring the Printer Driver Destination (Windows)". (→P.567)

Cannot print over AppleTalk or Bonjour networks

Cause	Corrective Action
The AppleTalk protocol is not enabled on the printer.	Activate AppleTalk on the printer. For details, see "Configuring the Printer's AppleTalk Network Settings". (→P.572)
The computer you are trying to print from is not configured correctly.	Make sure the computer's AppleTalk settings are configured correctly. For details, see "Configuring the Destination for AppleTalk Network (Macintosh)". (→P.574) or see "Configuring the Destination for Bonjour Network (Macintosh)". (→P.582)
The computer and printer are not on the same network.	Due to the nature of Bonjour, you cannot print if the printer is on another network behind a router. Make sure the computer and printer are on the same network. For information about network settings, ask your network administrator.

Cannot print over a NetWare network

Cause	Corrective Action
The printer's NetWare settings are not configured correctly.	Make sure the printer's NetWare settings are configured correctly. In particular, make sure a valid frame type is selected. For details, see "Configuring the Printer's NetWare Network Settings". (→P.557)
The computer you are trying to print from is not configured correctly.	Make sure the computer's NetWare settings are configured correctly. For details, see "Configuring NetWare Network Settings". (→P.566)
The NetWare server and services are not configured correctly.	<p>Check the following points.</p> <ol style="list-style-type: none"> 1. Make sure the NetWare file server is running. 2. Make sure there is enough free disk space on the NetWare file server. Insufficient disk space may prevent you from processing large print jobs. 3. Start NWADMIN or PCONSOLE and confirm that the print service is configured correctly and the print queue is available. 4. If data transmission to a printer on another subnet fails, deactivate NCP burst mode in that printer's network protocol settings. 5. If the printer is used in queue server mode, specify "Other/Unknown" as the printer type.

The printer stops during a print job

■ An error message is shown on the Display Screen

Status	Corrective Action
An error message is displayed during printing.	Check the error message and take action as necessary. (→P.689)
The last portion of roll paper was used during a print job, and paper could not be advanced because the trailing edge is taped to the roll.	Remove the used roll and insert a new roll. (→P.122) (→P.118) (→P.80)

■ The printer ejects blank, unprinted paper

Status	Corrective Action
The leading edge of the roll paper was cut to straighten it.	This operation is normal. The printer cuts the leading edge of the roll to straighten it and ejects the scraps when Trim Edge First in the printer menu is On or when Trim Edge First is Automatic and the leading edge is slanted. The printer is ready to print after this initial preparation. When Off is selected under Trim Edge First , the edge is not cut and scraps are not removed.
The Printhead nozzles are clogged.	Print a test pattern to check the nozzles and make sure the Printhead is in good condition for printing. (→P.623) Clean the Printhead if the nozzles are clogged. (→P.624)
A print job was received from an incompatible printer driver.	Use the correct imagePROGRAF printer driver for the printer and try printing again.
The printer is damaged.	Contact your Canon dealer for assistance.

Problems with the printing quality

☐ Printing is faint

Cause	Corrective Action
You may be printing on the wrong side of the paper.	Print on the printing surface.
The Printhead nozzles are clogged.	Print a test pattern to check the nozzles and see if they are clogged. (→P.623)
Because the printer was left without Ink Tanks installed for some time, ink has become clogged in the ink supply system.	After the Ink Tank has been installed for 24 hours, run Head Cleaning B . (→P.624)
Paper is jammed inside the Top Cover .	Follow the steps below to remove the jammed piece of paper inside the Top Cover . 1. Press the Online button to bring the printer offline. 2. Open the Top Cover and make sure the Carriage is not over the Platen . 3. Remove any scraps of paper inside the Top Cover . 4. Close the Top Cover . For tips on clearing paper jams, refer to the following topics. • Clearing Jammed Roll Paper (→P.138) • Clearing Jammed Paper from the Tray (→P.166)
During borderless printing, the ink was not dry enough before cutting.	Specify a longer drying period in the printer menu, in Roll DryingTime in Paper Details . (→P.49)
Printing may be faint if Print Quality in Advanced Settings in the printer driver is set to Standard or Draft .	In Advanced Settings in the printer driver, choose Highest or High in Print Quality . (→P.173)

■ Paper rubs against the Printhead

Cause	Corrective Action
<p>The paper type as specified in the printer driver does not match the type loaded in the printer. (*1)</p>	<p>Load paper of the same type as you have specified in the printer driver. (→P.119) (→P.156)</p>
	<p>Make sure the same type of paper is specified in the printer driver as you have loaded in the printer.</p> <ol style="list-style-type: none"> 1. Hold down the Stop button for a second or more to cancel printing. 2. Change the paper type in the printer driver and try printing again.
<p>Paper has been loaded incorrectly, causing it to wrinkle.</p>	<p>Reload the paper. (→P.119) (→P.156)</p>
<p>The Printhead is set too low.</p>	<p>In Head Height , choose Automatic . (→P.588)</p>
<p>You are printing on heavyweight paper or paper that curls or wrinkles easily after absorbing ink.</p>	<p>When printing on Heavyweight Coated Paper or other paper-based media, choose a VacuumStrngth setting of Strong , or Strongest . If the paper is still scratched, try setting the Printhead level in Head Height to Highest . (→P.595) (→P.588)</p>
	<p>When printing on CAD Tracing Paper or other film-based media, choose a VacuumStrngth setting of Standard , Strong , or Strongest . If the paper is still scratched, try setting the Printhead level in Head Height to Highest . (→P.595) (→P.588)</p>
	<p>When printing on paper 0.1 mm (0.004 in) thin or thinner, choose a VacuumStrngth setting of Weakest . If the paper is still scratched, try setting the Printhead level in Head Height to Highest . (→P.595) (→P.588)</p>
	<p>If edges of the paper curl and become soiled when printing on rolls of glossy photo paper, in Media Detailed Settings in the printer driver, set Near End Margin to 20mm .</p>

*1: Always make sure the loaded paper matches the media type setting on the printer.

☐ The edges of the paper are dirty

Cause	Corrective Action
The Platen has become dirty after borderless printing or printing on small paper.	Open the Top Cover and clean the Platen . (→P.640)
The paper type as specified on the printer does not match the type specified in the printer driver.	Make sure the same paper type is specified on the printer as in the printer driver. (→P.124) (→P.162)
	Make sure the same paper type is specified in the printer driver as on the printer. 1. Hold down the Stop button for a second or more to cancel printing. 2. Change the paper type in the printer driver and try printing again.
The paper is wrinkled or warped.	Straighten out the wrinkles or curls and reload the paper. Do not use paper that has been printed on previously. (→P.119) (→P.156)
A cut line is printed because the function to reduce cutting dust has been activated.	If this function is not needed, deactivate CutDustReduct. through the printer menu. (→P.49)
The Printhead is set too low.	In Head Height , choose Automatic . (→P.588)
You are printing on heavyweight paper or paper that curls or wrinkles easily after absorbing ink.	When printing on Heavyweight Coated Paper or other paper-based media, choose a VacuumStrngth setting of Strong , or Strongest . If the paper is still scratched, try setting the Printhead level in Head Height to Highest . (→P.595) (→P.588)
	When printing on CAD Tracing Paper or other film-based media, choose a VacuumStrngth setting of Standard , Strong , or Strongest . If the paper is still scratched, try setting the Printhead level in Head Height to Highest . (→P.595) (→P.588)
	If edges of the paper curl and become soiled when printing on rolls of glossy photo paper, in Media Detailed Settings in the printer driver, set Near End Margin to 20mm .
The Ejection Guide is soiled.	Clean the Ejection Guide . (→P.639)

☐☐☐ The surface of the paper is dirty

Cause	Corrective Action
The Paper Retainer is soiled.	Clean the Paper Retainer . (→P.643)
You are using a paper that does not dry easily.	Specify a time of about a minute in Roll DryingTime .

☐☐☐ The back side of the paper is dirty

Cause	Corrective Action
The Platen has become dirty after borderless printing or printing on small paper.	Open the Top Cover and clean the Platen . (→P.640)
The Paper Retainer is soiled.	Clean the Paper Retainer . (→P.643)

☐☐☐ Banding in different colors occurs

Cause	Corrective Action
The roll is not loaded correctly in the Roll Feed Unit .	Remove the roll and reload it. (→P.119)
The paper feed amount is not adjusted correctly.	Adjust the feed amount. (→P.589)
Printing does not proceed smoothly because print jobs are interrupted during transmission.	Exit other applications and cancel other print jobs.
In the printer menu, Print Length is specified in Feed Priority .	To adjust the feed amount, specify Band Joint in Feed Priority in the printer menu. (→P.589)
The Printhead is out of alignment.	Adjust the Printhead alignment. (→P.584)
Streaks may occur if you set the Print Quality too low.	Choose a higher level of Print Quality in the Advanced Settings of the printer driver and try printing again. (→P.173)

☐☐☐ The contrast becomes uneven during printing

Cause	Corrective Action
The paper feed amount is out of adjustment.	Adjust the feed amount. (→P.589)
	Execute Fine Band Adj. during printing. (→P.589)

☐☐☐ Colors in printed images are uneven

Cause	Corrective Action
Line Drawing/Text is selected when printing images in many solid colors.	Specify Image in the printer driver.
You are printing on paper that curls easily.	Printed colors may appear uneven on the leading edge of paper that is susceptible to curling. Increase the level of vacuum holding the paper against the Platen or specify a margin of 20 mm (0.79 in) or more for the leading edge. (→P.595)
If you use Glossy Paper , art paper or Coated Paper , color shading may appear at the rear edges of the paper.	In Advanced Settings of the printer driver, choose Highest or High in Print Quality . (→P.173)
Printed colors may be uneven if you set the Print Quality too low.	Choose a higher level of Print Quality in the Advanced Settings of the printer driver. (→P.173)
Color may be uneven between dark and light image areas.	Select Unidirectional Printing in the Advanced Settings of the printer driver.
When using Borderless Printing, the edge of the paper is cut during printing. Thus, ink density may not be even at the edges.	Specify No in Auto Cut in the printer driver before printing. In this case, the paper can be printed without borders on the left and right sides only. Cut the printed document ejected from the printer, then use scissors to cut away the edges on the top and bottom.
	Choose a higher level of Print Quality in the Advanced Settings of the printer driver. (→P.173)
The Printhead is out of alignment.	Adjust the Printhead alignment. (→P.584)
Drying documents stacked on each other may cause uneven colors.	To avoid uneven colors, we recommend drying each sheet separately.

Problems with the printing quality caused by the type of paper

For paper-specific troubleshooting tips to improve the printing quality, refer to the Paper Reference Guide. (→P.108)

Lines are misaligned

Cause	Corrective Action
The Printhead alignment is not adjusted.	Adjust the Printhead alignment. (→P.584) (→P.586)

The length of printed images is inaccurate

Cause	Corrective Action
In the printer menu, Band Joint is specified in Feed Priority .	To ensure the feed amount matches the paper size, select Print Length in Feed Priority in the printer menu and enter the amount for adjustment in Adjust Length . You can adjust the feed amount in 0.02% increments. (→P.49)

Documents are printed in monochrome

Cause	Corrective Action
In the Advanced Settings of the printer driver, Monochrome or Monochrome (Photo) , is specified in Color Mode .	In the Advanced Settings of the printer driver, specify Color in Color Mode and try printing again.
The Printhead nozzles are clogged.	Print a test pattern to check the color ink nozzles and see if they are clogged. (→P.623)

Printed colors are inaccurate

Cause	Corrective Action
Color adjustment has not been activated in the Advanced Settings of the printer driver.	In the Advanced Settings of the printer driver, access Color Settings in Color Mode to adjust colors.
Colors have not been adjusted on the computer or monitor.	Refer to the computer and monitor documentation to adjust the colors.
	Adjust the settings of the color management software, referring to the software documentation as needed.
The Printhead nozzles are clogged.	Print a test pattern to check the nozzles and see if they are clogged. (→P.623)
In the printer driver, Application Color Matching Priority is not selected.	Click Special Settings on the Layout sheet of the printer driver and select Application Color Matching Priority in the dialog box.
There may be a slight difference in how colors are printed after you replace the Printhead because of individual variation among Printheads .	Execute color calibration.
Printhead characteristics gradually change through repeated use, and colors may change.	Execute color calibration.
Color may change slightly even on the same model of printer if you use a different version of the firmware or printer driver, or when you print under different settings or in a different printing environment.	Follow these steps to prepare the printing environment. 1. Use the same version of firmware or printer driver. 2. Specify the same value for all settings items. 3. Execute color calibration.
The region selection of the Media Configuration Tool was changed when you reinstalled the printer driver. If you change the region selection of the Media Configuration Tool , region-specific paper information originally registered on the printer before installation will be deleted. If the information of paper you used for color calibration is deleted, such color calibration can no longer be applied to any type of paper.	Perform color calibration again using paper supported in the newly selected region and compatible with color calibration.

Image Edges are Blurred or White Banding Occurs

Cause	Corrective Action
The Platen suction is too strong.	Set VacuumStrength to Weakest . (→P.595)
The Printhead is set too high.	Lower the Printhead . (→P.588)

Documents are printed crooked

Cause	Corrective Action
Skew Skew Check Lv. has been set to Loose or Off .	Choose Standard in Skew Check Lv. .
Width Detection has been set to Off .	Choose On in Width Detection .

White dots about 1 mm (0.039 in) apart appear on printed documents, in the direction paper is fed.

Cause	Corrective Action
The media type setting is incorrect.	After you select the correct media type, clean the parts used in paper feeding (spurs). (→P.162) (→P.124) (→P.644)
Parts used in paper feeding (spurs) are soiled.	Clean the Spurs. (→P.644)

Immediately After Borderless Printing, the Trailing Edge Margin is Soiled During Regular Printing

Cause	Corrective Action
Depending on your printing environment, after borderless printing in which the leading and trailing edge of the roll is cut automatically, any ink adhering to the cutter unit may rub off on the next printed document.	Follow these steps to set the Between Pages setting of Drying Time in a range of 30 seconds to 3 minutes before borderless printing. 1. On the Main sheet of the printer driver, click Settings in Media Type . 2. Select the ink drying time in the Between Pages list of Drying Time .

Roller marks are left across the trailing edge of paper

Cause	Corrective Action
A document was removed after printing from the Front Paper Feed Slot without pressing the Load/Eject button.	Following the instructions, press the Load/Eject button, remove the paper, and then press the OK button.
	Wipe away any soiling on the rollers. (→P.640) (→P.643)

Line thickness is not uniform (Windows)

Cause	Corrective Action
In the Special Settings dialog box of the Windows printer driver, Fast Graphic Process is selected.	<p>Open the printer driver's Properties dialog box from Print in the application software's File menu, and try printing following the steps below.</p> <ol style="list-style-type: none"> 1. Remove the check from Open Preview When Print Job Starts in the Main sheet. 2. Remove the check from Page Layout in the Layout sheet. 3. Click the Special Settings button in the Layout sheet to open the Special Settings dialog box, and remove the check from Fast Graphic Process .

Installation problems

☒ The IEEE 1394 Driver Cannot Be Installed Correctly

In Windows, the device interface driver may not be installed correctly in some cases if you connected the IEEE 1394 cable before installing the printer driver.

If so, reinstall the IEEE 1394 device interface driver and the printer driver as follows.



Important

- This procedure is based on an example for Windows XP. The name of the wizard may be different in other operating systems.

1. Right-click **My Computer** and choose **Properties** to display the **System Properties** window.
2. On the **Hardware** sheet, click **Device Manager** to display the **Device Manager** window.
3. Right-click **Other Devices** icon and choose **Properties**.
4. On the **Driver** sheet, click **Update Driver** to start the **Hardware Update Wizard** (or the **Upgrade Device Driver Wizard**.)
5. Follow the instructions on the screen.
6. When the window is displayed to choose the source for driver installation, select the CD-ROM drive. Insert the User Software CD-ROM provided with the printer and follow the instructions on the screen.
The device/interface driver is installed.
The device is detected, and the **New Hardware Wizard** (or **Add New Hardware Wizard**) is started.
7. Follow the instructions on the screen.
8. When the window is displayed to choose the source for driver installation, select the printer driver folder.
Choose the CD-ROM drive > **Driver** > **WinXP_2K** > **Driver**, and click **OK**. (For Windows 2000/Windows XP/Windows Server 2003)
9. Follow the instructions on the screen.
The printer driver is installed.

Removing Installed Printer Drivers

Follow the steps below to remove installed printer drivers and utilities.

Removing printer drivers (Windows)

Remove the printer driver as follows.



Note

- In Windows 2000/Windows XP/Windows Server 2003/Windows Vista, you must log on with administrative rights such as “Administrator” account.

1. From the Windows **start** menu, select **Programs > Canon Printer Uninstaller > imagePROGRAF Printer Driver Uninstaller** to display the **Delete Printer** window.
2. Select the printer in the list and click **Delete**.
3. Click **Yes** in the **Warning** message dialog box.
4. Make sure that the printer has been removed from the list, and click **Exit**.

Removing Printer Drivers and imagePROGRAF Printmonitor (Macintosh)

Remove the printer driver or imagePROGRAF Printmonitor as follows.

1. Insert the User Software CD-ROM provided with the printer in the CD-ROM drive.
2. Start the printer driver installer included in the User Software CD-ROM.
For Mac OS X, open **OS X** and double-click **iPF Driver Installer X**.
For Mac OS 9, open **OS 9** and double-click **iPF Driver Installer 9**.
3. In the upper-left menu, choose **Uninstall**, and click **Uninstall**.
4. Follow the instructions on the screen to remove the printer driver or imagePROGRAF Printmonitor.

Removing imagePROGRAF Status Monitor (Windows)

Remove imagePROGRAF Status Monitor as follows.

1. From the Windows **start** menu, select **Programs > imagePROGRAF Status Monitor > Uninstaller (imagePROGRAF Status Monitor)** to start the wizard.
2. In the wizard window, click **Delete**, and then click **Next**.
3. Follow the instructions on the screen to remove imagePROGRAF Status Monitor.

Removing imagePROGRAF Device Setup Utility (Windows)

Remove imagePROGRAF Device Setup Utility as follows.

1. From the Windows **start** menu, select **Programs > imagePROGRAF Device Setup Utility > Uninstaller (imagePROGRAF Device Setup Utility)** to start the wizard.
2. In the wizard window, click **Delete**, and then click **Next**.
3. Follow the instructions on the screen to remove imagePROGRAF Device Setup Utility.

Clearing jammed paper

Clearing Jammed Roll Paper

If paper from a roll becomes jammed, **Paper jam.** is shown on the Display Screen of the Control Panel. Remove the jammed paper as follows.



Note

- For instructions on removing a paper jam from a roll if the scrap of paper remains in the Paper Feed Slot, see “Clearing Jammed Paper (Paper Feed Slot)”. (→P.142)

1. Open the Roll Paper Unit Cover. Use a store-bought cutter or the like to cut the paper of the loaded roll.

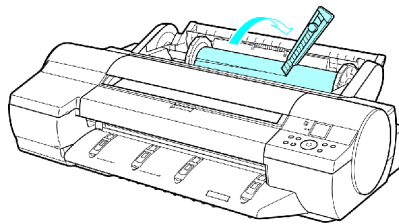

Caution

- When cutting paper, be careful to avoid scratching the printer.

2. Press **Load/Eject** button.

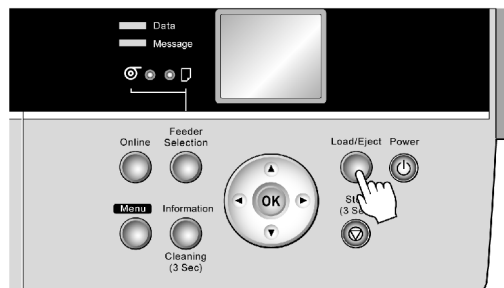

3. Remove the jammed paper.

- If paper is jammed inside the Top Cover

1. Open the Top Cover and move the Carriage to the side.

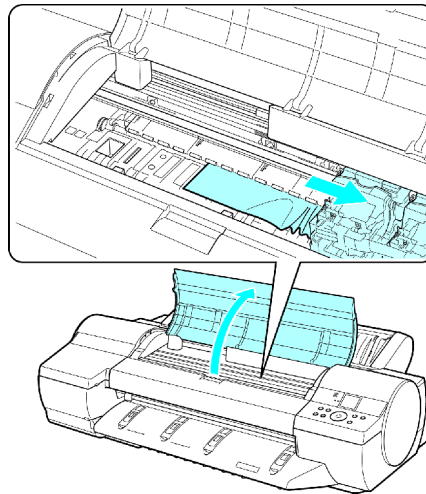

2. Clear any jammed paper from inside the Top Cover.

After removing the paper, make sure there are no other scraps of paper in the printer.

3. Close the Top Cover.

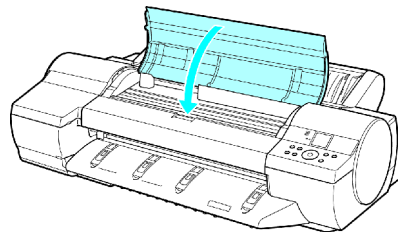

Important

- Do not touch the Linear Scale (a) or Carriage Shaft (b).

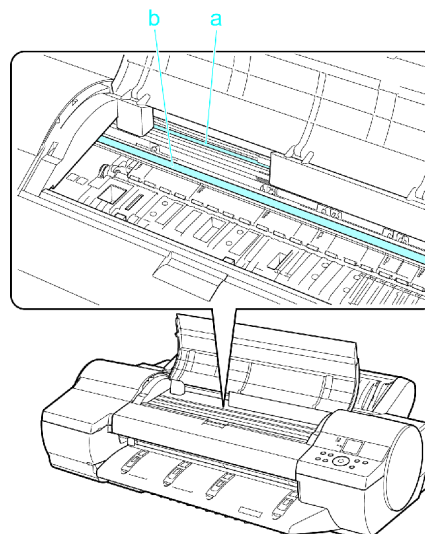

Clearing jammed paper

- If paper from a roll is jammed by the Paper Feed Slot

1. Open the Roll Paper Unit Cover.

2. Remove the jammed paper from the Paper Feed Slot.

After removing the paper, make sure there are no other scraps of paper in the printer. If paper is jammed deep in the Paper Feed Slot (→P.677), remove the Roll Feed Unit and clear the paper jam.

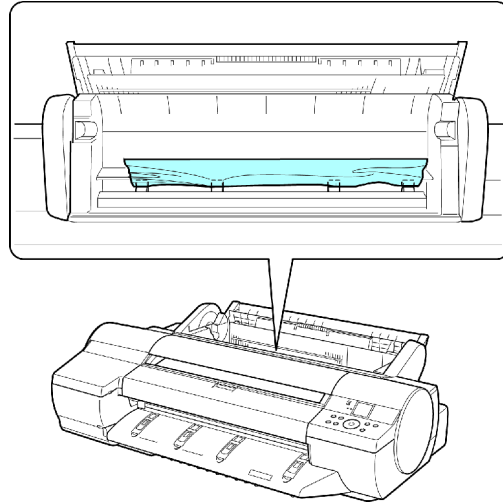

- If the paper is jammed by the Ejection Guide

Remove the jammed paper from the Output Tray.

After removing the paper, make sure there are no other scraps of paper in the printer.

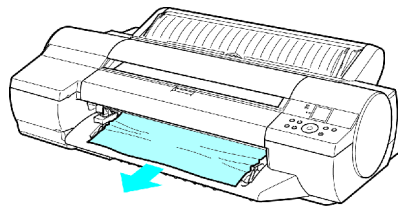

4. Press **OK**.

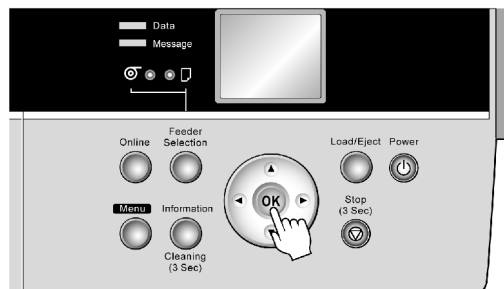

If paper is jammed deep in the Paper Feed Slot, remove the Roll Feed Unit and clear the paper jam as follows.

- 1.** Turn off the printer and remove the Roll Feed Unit from the printer. (→P.147)
- 2.** Remove the jammed paper from the Paper Feed Slot.

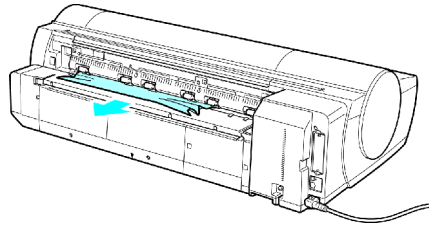

After removing the paper, make sure there are no other scraps of paper in the printer.

- 3.** Install the Roll Feed Unit on the printer again. (→P.148)

☐ Clearing Jammed Paper (Paper Feed Slot)

Follow these steps to remove any scraps left in the Paper Feed Slot after you clear jammed sheets or roll paper.

1. Press the **Feeder Selection** button to activate the **Cut Sheet lamp**.
2. Press the **Load/Eject** button.
A screen is displayed for paper type selection.
3. Select POP Board and press the **OK** button.
A screen is displayed for paper size selection.
4. Select the desired size and press the **OK** button.
Instructions for feeding POP Board are shown on the Control Panel, but instead of following them, follow this procedure to remove the jammed paper.
5. Open the Top Cover.
6. Fold an A4 sheet lengthwise four times and insert it through the gap of the Back Cover. Push the scrap out toward the Platen.

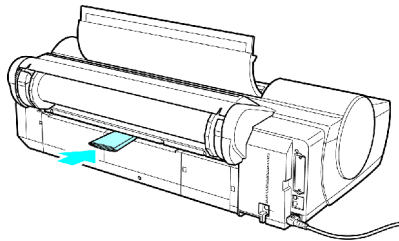

7. Remove the scrap when it is pushed out onto the Platen.
8. If any scraps remain inside the Paper Feed Slot, repeat steps 6 and 7.
9. Close the Top Cover.
10. Turn the printer off. (→P.19)

Clearing Jammed Paper from the Tray

If a sheet loaded manually becomes jammed, **Paper jam.** is shown on the Display Screen of the Control Panel. Remove the jammed paper as follows.

1. Press Load/Eject.

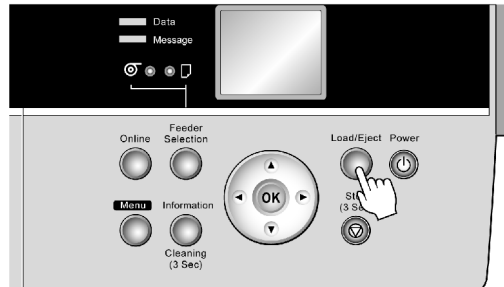

2. Remove the jammed paper.

- If paper is jammed inside the Top Cover

1. Open the Top Cover and move the Carriage to the side manually.

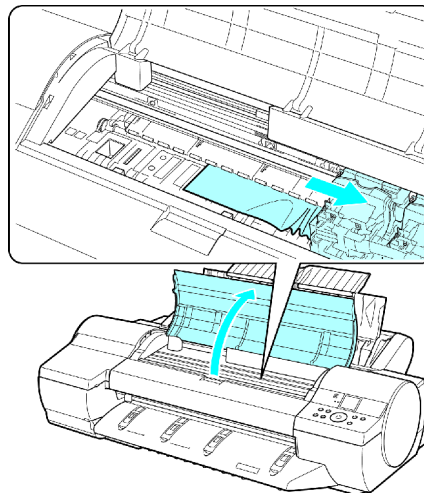

2. Clear any jammed paper from inside the Top Cover.

After removing the paper, make sure there are no other scraps of paper in the printer.

3. Close the Top Cover.

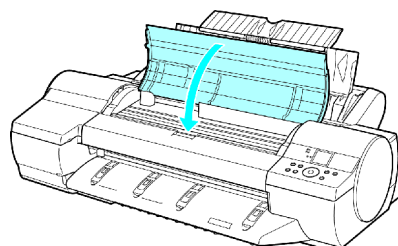

Clearing jammed paper



Important

- Do not touch the Linear Scale (a) or Carriage Shaft (b).

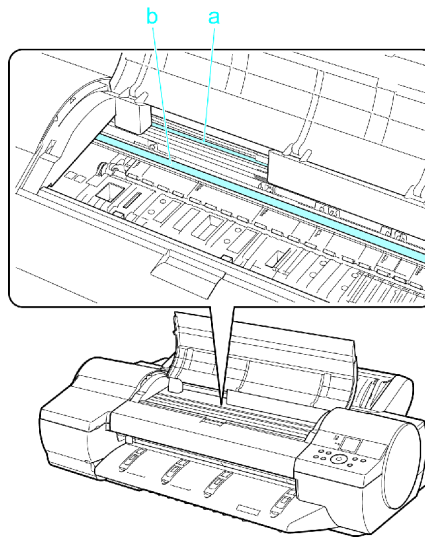

- If paper is jammed by the Paper Feed Slot of the Top Paper Feed Slot
Remove the jammed paper from the Paper Feed Slot.
After removing the paper, make sure there are no other scraps of paper in the printer. If paper is jammed deep in the Paper Feed Slot (→P.681), remove the Roll Feed Unit and clear the paper jam.

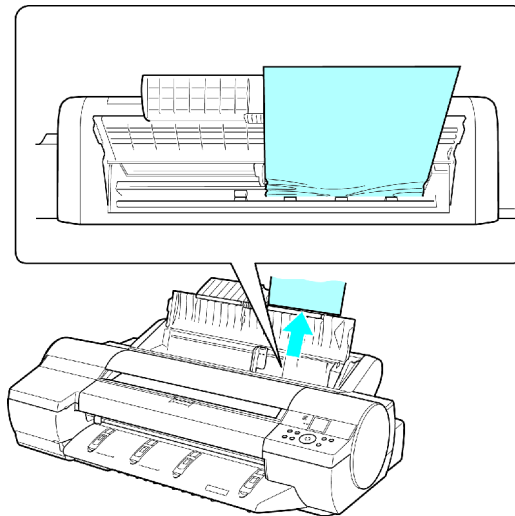

- If the paper is jammed by the Ejection Guide
Remove the jammed paper from the Output Tray.
After removing the paper, make sure there are no other scraps of paper in the printer.

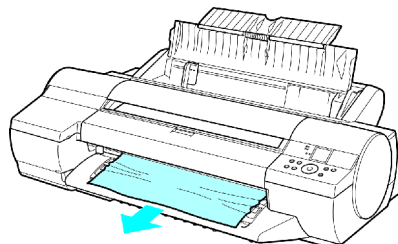

- If paper is jammed in the back of the printer
Remove the jammed paper from the back.
After removing the paper, make sure there are no other scraps of paper in the printer.

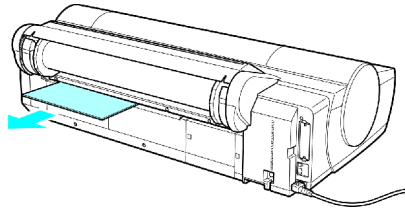

3. Press **OK** button.

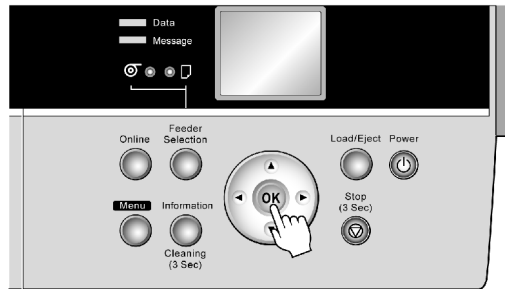

If paper is jammed deep in the Paper Feed Slot, remove the Roll Feed Unit and clear the paper jam as follows.

- 1.** Turn off the printer and remove the Roll Feed Unit from the printer.
(→P.147)
- 2.** Remove the jammed paper from the Paper Feed Slot.

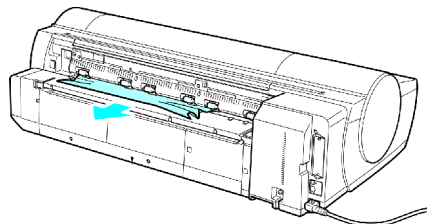

After removing the paper, make sure there are no other scraps of paper in the printer.

- 3.** Install the Roll Feed Unit on the printer again.
(→P.148)

If the Printer makes a strange sound

☰ If the Printer Makes a Strange Sound

The following sounds do not indicate a problem with the printer.

- There is a sound of vacuum from the Platen
To prevent paper from rising, paper is held against the Platen by suction from Vacuum holes under it.
- Roll paper makes a fluttering sound during printing
There may be a fluttering sound when large paper is advanced.
- If you suddenly hear the tone for cleaning operations
At regular intervals, for printer maintenance, cleaning operations will begin automatically, even if the printer is in Sleep mode.

In other cases, contact your Canon dealer.

Other problems

☐ The printer consumes a lot of ink

Cause	Corrective Action
Many full-page color images are printed.	In print jobs such as photos, images are filled with color. This consumes a lot of ink. This does not indicate a problem with the printer.
Head Cleaning B is used often.	Head Cleaning B consumes a lot of ink. This does not indicate a problem with the printer. Unless the printer has been moved or stored for a long period or you are troubleshooting Printhead problems, we recommend not performing Head Cleaning B , to the extent possible.
You have just finished initial installation, when more ink is consumed to fill the system.	After initial installation or at the first-time use after transfer, ink flows into the system between the Ink Tank and Printhead , which may cause the ink level indicators to drop to 80%. This does not indicate a problem with the printer.

☐ A message to check the Maintenance Cartridge is not cleared after you replace the Maintenance Cartridge

Cause	Corrective Action
The printer has not detected the new Maintenance Cartridge .	Remove the new Maintenance Cartridge you have just installed and insert it again firmly.
	Restart the printer.

☐ Paper is not cut straight

Cause	Corrective Action
The paper is bent or curled at the cut position.	Straighten out any curling by the edges of the paper.
Paper rises by the ends of the cut position before it is cut.	Reload the paper correctly.

☐ Paper cannot be cut

Cause	Corrective Action
The printed document became caught on a foreign object by the Output Tray , which lifted the document. The Cutter passed under the paper.	Remove the foreign object by the Output Tray to enable the printer to eject the printed document, keeping it level.
In the printer driver, No or Print Cut Guideline is specified in Auto Cut .	Specify Yes in Auto Cut in the printer driver.
In MAIN MENU , Eject or Manual is specified in Cutting Mode .	Specify Automatic in Cutting Mode in MAIN MENU .

☐☐☐ Depression on the leading edge is left

Cause	Corrective Action
Keeping a roll in the printer for a long time without printing on it may leave a depression on the leading edge.	When printing quality is most important, we recommend setting TrimEdge Reload to On or Automatic so that the paper edge is automatically cut before printing.

☐☐☐ Roller marks are left across the trailing edge of paper

Cause	Corrective Action
A document was removed after printing from the Front Paper Feed Slot without pressing the Load/Eject button.	Following the instructions, press the Load/Eject button, remove the paper, and then press the OK button.
	Wipe away any soiling on the rollers. (→P.640) (→P.643)

☐☐☐ The printer does not go on

Cause	Corrective Action
The printer is unplugged.	Plug the power cord into the outlet, and then turn on the printer.
The specified voltage is not supplied.	Check the voltage of the outlet and breaker. For information on the specified voltage, see "Specifications". (→P.72)

☐☐☐ Roll paper cannot be inserted into the Paper Feed Slot

Cause	Corrective Action
The roll paper is warped.	Straighten out curls and reload the roll.
The roll was pulled out by force when it had been advanced before printing, and this action closed the Paper Feed Slot .	Hold down the Load/Eject button for a while and reload the roll.

☐☐☐ Cannot Load Sheets

Cause	Corrective Action
The paper source selection is incorrect.	Press the Feeder Selection button to activate the Cut Sheet lamp .

■ Ink level detection

Ink level detection will be deactivated if you load ink tanks once emptied.

Ink level detection

Ink Tanks (→P.613) specified for this printer feature an ink level detection function to prevent the ink from running out during printing, which prevents printer damage.

This function will not work correctly if you use refill ink tanks. As a result, printing stops. Thus, before using refill ink tanks, you must cancel the ink level detection.

Printing with the ink level detection canceled may lead to printer damage and printing problems. Canon Inc. is not liable for any damage that may occur as a result of refilling ink.



Caution

- After ink level detection has been disabled, this function cannot be reactivated for the currently loaded Ink Tank. To use ink level detection again, replace the Ink Tank with a new ink tank specified for use with the printer.
- Repeatedly removing and inserting an Ink Tank may damage the connection between the Ink Tank and the printer, which may cause ink leakage from the Ink Tank and damage the printer.

Disabling Ink Level Detection

1. On the Display Screen, a message indicates that the ink level cannot be detected.

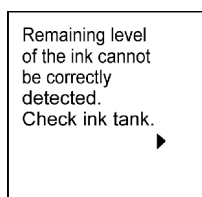

2. Press ▲ or ▼ to select **Information**, and then press the **OK** button.

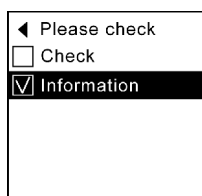

A confirmation message is shown on the Display Screen about disabling ink level detection.

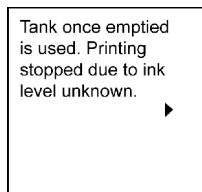

3. Press ► and check the message on the Display Screen.

4. Press ▲ or ▼ to select **Yes**, and then press the **OK** button.

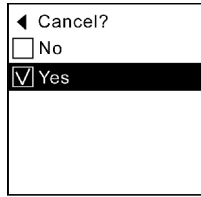

A confirmation message is shown on the Display Screen.

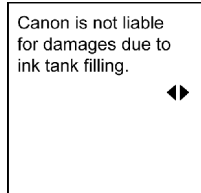

5. Press ▲ or ▼ to select **Yes**, and then press the **OK** button.

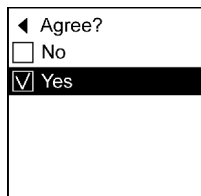

A confirmation message about updating ink information is shown on the Display Screen.

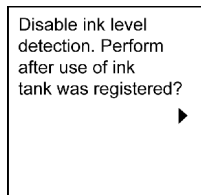

6. Press ▲ or ▼ to select **Yes**, and then press the **OK** button.

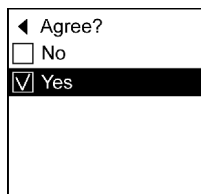

Ink level detection is now disabled, and the printer goes online.

Error Message

Responding to Messages

Responding to Error Messages

Warning messages

Warning messages are shown on lines 2-4 of the Display Screen.

Although warning messages do not prevent printer operation, you should check the message and take the appropriate action. (→P.689)

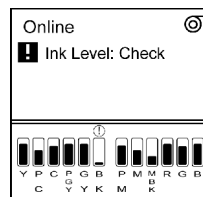

Error messages (if action can be taken)

Error messages are indicated on the Display Screen if you must respond before the printer can resume operation.

Check the message and take the appropriate action. (→P.689)

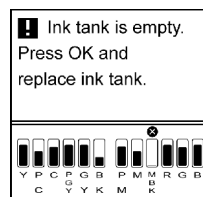

Error messages (if no action can be taken)

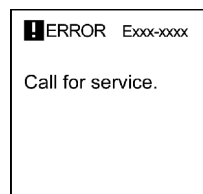

In the following situations, turn off the printer and wait at least three seconds before restoring power.

If the message is still displayed, write down the error code and message, turn off the printer, and contact your Canon dealer for assistance.

- The error message is displayed with the following instructions: **Turn off printer, wait, then turn on again.**
- “ERROR” is displayed, followed by the error code and **Call for service.**

Other Messages

These messages do not prevent printer operation. Check the information on the Display Screen and take action as necessary. Messages requiring special attention are as follows:



Note

- Messages are also displayed in imagePROGRAF Status Monitor (Windows) or **imagePROGRAF Printmonitor** (Macintosh).

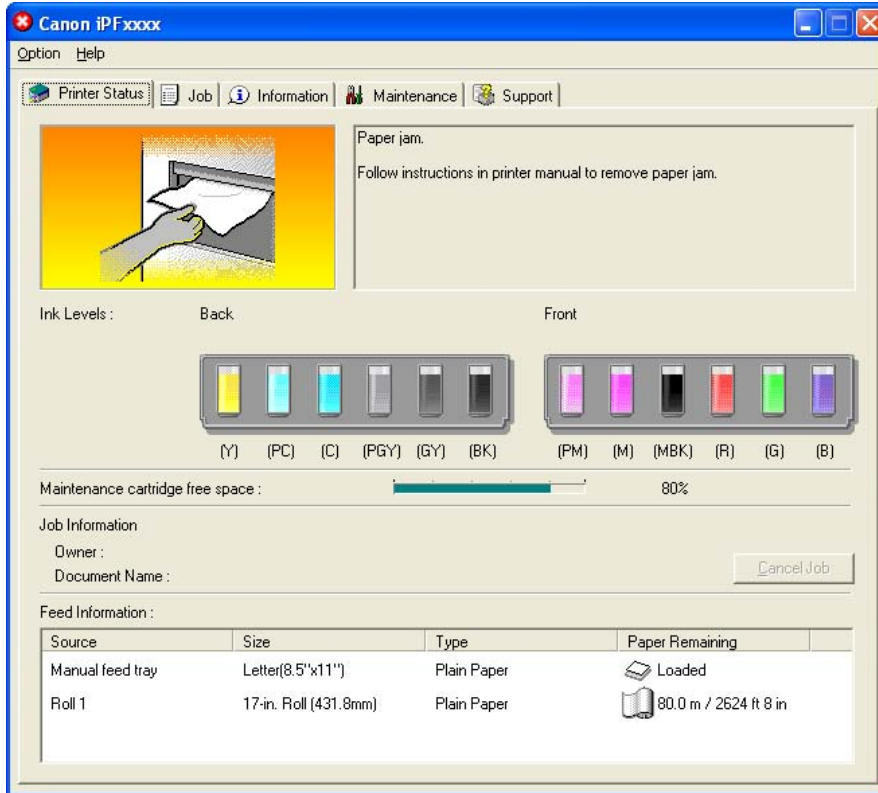

Error Messages

Warning messages

Warning messages are shown on lines 2-4 of the Display Screen.

Although warning messages do not prevent printer operation, you should check the message and take the appropriate action.

- **GARO Wxxxx** (x represents a number) (→P.709)
- **Ink Level: Check** (→P.701)
- **End of paper feed.** (→P.698)
- **Prepare for parts replacement.** (→P.709)
- **Parts replacement time has passed.** (→P.709)
- **Problem with Printhead x** (x is L, R, or LR) (→P.707)
- **Prepare for maint cart replacement.** (→P.708)
- **Paper Mismatch** (→P.691)
- **Papr Size Mismatch** (→P.692)
- **Papr Type Mismatch** (→P.691)

Error messages (if action can be taken)

Check the message and take the appropriate action.

- **Ink tank is empty.** (→P.703)
- **Ink insufficient.** (→P.702)
- **No ink tank loaded.** (→P.701)
- **Ink tank error.** (→P.703)
- **Top cover is open.** (→P.709)
- **Sheet printing is selected.** (→P.694)
- **Cannot calibrate.** (→P.705)
- **Cannot feed paper.** (→P.695)
- **Insufficient paper for job** (→P.693)
- **Use another paper.** (→P.704)
- **This paper cannot be used.** (→P.692)
- **Cannot print as specified.** (→P.704)
- **Manual printing is selected, but a roll is loaded.** (→P.695)
- **Wrong paper feed slot for this paper type.** (→P.695)
- **Cannot adjust band.** (→P.704)
- **Unknown file.** (→P.709)
- **Borderless printng not possible.** (→P.696)
- **x printhead error** (x is Left or Right) (→P.707)
- **x printhead needs cleaning.** (x is Left or Right) (→P.706)
- **PHeads: wrong pos.** (→P.706)
- **Cannot adjust printhead.** (→P.705)
- **Multi-sensor error** (→P.710)
- **Maintenance cartridge problem.** (→P.708)
- **Maintenance cartridge full.** (→P.708)
- **No maintenance cartridge.** (→P.708)
- **No Maintenance Cartridge capacity.** (→P.708)
- **Paper Mismatch** (→P.691)
- **Paper jam.** (→P.699)
- **Paper loaded askew.** (→P.697)

Responding to Messages

- **Papr Size Mismatch** (→P.692)
- **Paper size not detected.** (→P.697)
- **Papr Type Mismatch** (→P.691)
- **Cannot feed paper.** (→P.698)
- **Cannot cut paper.** (→P.699)
- **Cannot detect papr** (→P.698)
- **Roll printing is selected.** (→P.694)
- **Roll printing is selected, but sheets are loaded.** (→P.694)
- **The roll is empty.** (→P.700)
- **Roll feed unit err** (→P.700)
- **No Roll Feed Unit.** (→P.700)

Error messages (if no action can be taken)

- **Hardware error. xxxxxxxx-xxxx** (x represents a letter or number) (→P.710)
- **ERROR Exxx-xxxx** (x represents a letter or number) (→P.709)

Other Messages

These messages do not prevent printer operation. Check the information on the Display Screen and take action as necessary. Messages requiring special attention are as follows:

- **Remaining level of the ink cannot be correctly detected.** (→P.703)
- **Excessive temperature or humidity.** (→P.705)
- **Cannot execute this command. Use other paper.** (→P.704)

Messages regarding paper

■ ■ ■ Paper Mismatch

Cause	Corrective Action
You printed a test pattern for printer adjustment on several sheets, but sheets of different types or sizes of paper were used.	When printing a test pattern, use sheets of the same type and size of paper.

■ ■ ■ Paper Type Mismatch

Cause	Corrective Action
The paper type as specified on the printer does not match the type specified in the printer driver.	Make sure the same type of paper is specified on the printer as in the printer driver. (→P.80) (→P.85)
	Follow these steps to ensure the paper type matches on the printer and in the printer driver. 1. Hold down the Stop button for a second or more to cancel printing. 2. Either change the type of paper specified in the printer driver settings or replace the loaded paper and change the paper type setting on the printer.
	Press the Online button to resume printing. However, this may cause a paper jam or printing problem.

*Printing will continue if you have set **Detect Mismatch** to **Warning** or **None**.

■ ■ ■ Paper Size Mismatch

Cause		Corrective Action
The paper size as specified on the printer does not match the size specified in the printer driver.	If you have selected Fit Roll Paper Width in the printer driver settings and Warning in Detect Mismatch in the printer menu:	Printing resumes after the warning message is displayed. However, note that this error may cause paper jams and affect the printing quality. Try printing again after adjusting the paper size as specified in the printer driver and the size specified on the printer so that they match.
	If you have selected Fit Roll Paper Width in the printer driver settings and Pause in Detect Mismatch in the printer menu:	Follow the steps below to ensure the paper size matches on the printer and in the printer driver. 1. Hold down the Stop button for a second or more to cancel printing. 2. Load paper of the same size as you have specified in the printer driver. 3. Change the paper size in the printer driver and try printing again.
		Press the Online button to resume printing. However, this may cause a paper jam or printing problem.

■ ■ ■ This paper cannot be used.

Check supported paper sizes.

Cause	Corrective Action
The loaded paper is too large for the printer.	Load paper of the correct size. (→P.113)
The loaded paper is too small for the printer.	Load paper of the correct size. (→P.113)
Paper has been loaded that is too small to print the test pattern for printhead adjustment or nozzle checking.	Load unused paper A4/Letter-sized or larger. More than one sheet may be required depending on the adjustment.

Insufficient paper for job

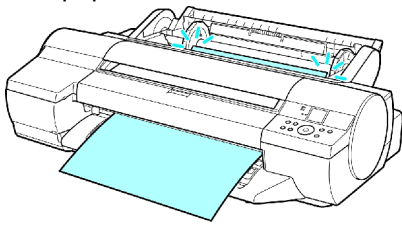
Cause	Corrective Action
<p>The printer has received a print job longer than the amount of roll paper left.</p> 	<p>Follow the steps below to replace the roll.</p> <ol style="list-style-type: none"> 1. Remove the roll. (→P.122) (→P.118) 2. Load a roll with enough paper left. (→P.116) (→P.119) 3. If no barcode was printed on the roll, specify the paper type. (→P.124) 4. Select the paper length, unless a barcode was printed on the roll and you have deactivated automatic detection of the remaining roll paper. (→P.125) <p>Hold down the Stop button for a second or more to cancel printing.</p> <p>Press the Online button to resume printing. However, the roll paper may run out during the print job and you may not be able to print all of the document.</p>

Roll printing is selected, but sheets are loaded.

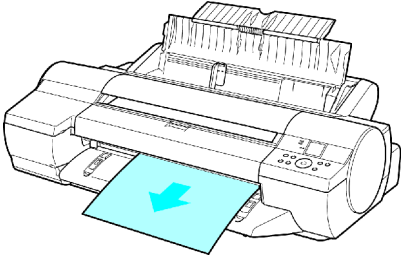
Cause	Corrective Action
<p>A print job for rolls was received when a sheet is loaded.</p> 	<p>Press the OK button and remove the sheet. (→P.164) Load a roll and try printing again. (→P.80)</p> <p>Hold down the Stop button for a second or more to cancel printing.</p>

Roll printing is selected.

Cause	Corrective Action
<p>You have attempted to print a test print sheet or other printer status information on a roll, but no roll is loaded.</p>	<p>Load a roll and try printing again.</p> <p>To print on a sheet instead, hold the Stop button for more than a second to cancel printing, load a sheet, and then print. (→P.85)</p>

Sheet printing is selected.

Cause	Corrective Action
<p>You have attempted to print a test print sheet or other printer status information on a sheet, but no sheet is loaded.</p>	<p>Load a sheet and try printing again.</p> <p>To print on a roll instead, hold the Stop button for more than a second to cancel printing, load a roll, and then print. (→P.80)</p>

Wrong paper feed slot for this paper type.

Cause	Corrective Action
The Paper Feed Slot where paper is loaded does not match the Paper Feed Slot specified as the paper source.	Try printing again after changing the settings in the printer driver so that the Paper Feed Slot where paper is loaded matches the Paper Feed Slot specified as the paper source. (→P.85)

Manual printing is selected, but a roll is loaded.

Cause	Corrective Action
A print job for manually printing on sheets was sent when a roll is loaded.	Hold down the Stop button for a second or more to cancel printing.
	Load paper of the type and size you have specified in the printer driver. (→P.85)
	Hold down the Stop button for a second or more to cancel printing. Change the printer driver settings to match the roll already loaded, and then try printing again.

Cannot feed paper.

Cause	Corrective Action
The paper has come out of the printer.	Remove the paper, press the Load/Eject button, and reload the paper.
A paper jam has occurred.	Press the Load/Eject button, remove the jammed paper, and reload paper.
	If the error occurs again, turn off the printer and wait a while before restoring power.

❏ Borderless printing not possible.

Check roll width and spacers.

Cause	Corrective Action
The paper is loaded askew.	Insert the paper and Spacer for Borderless Printing firmly all the way into the printer.
	When using A1 or A2 rolls, attach the Spacer for Borderless Printing before loading the roll. (→P.144)
	When using sizes other than A1 or A2, remove the Spacer for Borderless Printing before loading the roll. (→P.144)
The paper loaded is not compatible with borderless printing.	Load paper compatible with borderless printing and try printing again. Paper you can use for borderless printing is restricted to particular types of paper and rolls of particular widths. For information on types of paper compatible with borderless printing, refer to the Paper Reference Guide . (→P.108)
Because paper expands or contracts depending on the environment of use, it may become narrower or wider than the supported width for borderless printing.	Use each type of paper only where the recommended environmental conditions are met. For details on environmental conditions for various paper, see the Paper Reference Guide . (→P.108)

Check supported paper.

Cause	Corrective Action
The print job received specifies a type or width of paper that is not compatible with borderless printing.	Follow these steps to change the settings of the print job to enable borderless printing. 1. Hold down the Stop button for a second or more to cancel printing. 2. Make sure the correct printer driver for the printer is selected and try printing again. For information on types of paper compatible with borderless printing, refer to the Paper Reference Guide . (→P.108)
	If you press the Online button and continue printing, the document will be printed with a border.

⌘ Paper loaded askew.

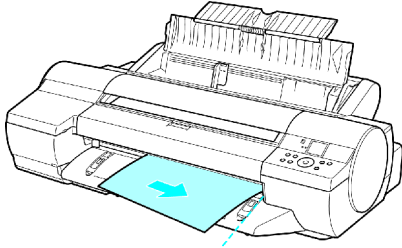
Cause	Corrective Action
Paper has been loaded askew. 	Follow these steps to reload a roll. 1. Remove the crooked paper. 2. Press the Load/Eject button and reload the roll. (→P.119) Follow these step to reload a sheet. 1. Remove the crooked paper. 2. Press the Load/Eject button and reload the sheet. (→P.156)



Note

- To disable this message (if it is displayed repeatedly despite reloading paper, for example), choose **Off** or **Loose** in the **Skew Check Lv.** setting of the printer menu. However, this may cause jams if paper is crooked when printed. Also, the Platen may become soiled, which may soil the back of the next document when it is printed.

⌘ Paper size not detected.

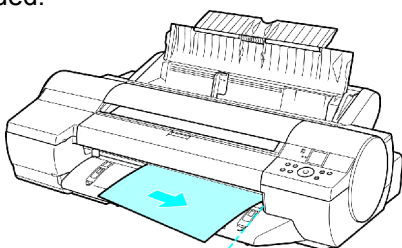
Cause	Corrective Action
Paper has been loaded askew, or warped paper has been loaded. 	Reload paper straight, in the correct position. (→P.119) (→P.156)

Cannot detect paper

Cause	Corrective Action
The paper has come out of the printer.	Remove the paper that has come out of the printer, press the Load/Eject button, and reload the paper. (→P.80) (→P.85)
A paper jam occurred in the printer.	Remove the jammed paper, press the Load/Eject button, and reload paper. (→P.138) (→P.166)
The roll cannot be correctly detected.	Rewind the roll manually until the paper caught in the rollers is completely out of the rollers. Press the Load/Eject button and reload the roll.

End of paper feed.

Cause	Corrective Action
You are pressing the ▲ button on the Control Panel and trying to rewind the roll to the edge.	Release the ▲ button.

Cannot feed paper.

Cause	Corrective Action
The sheet cannot be fed correctly.	Reload the sheet straight, in the correct position. (→P.156)

■ Paper jam.

Cause	Corrective Action
A paper jam occurred in the printer during printing.	Press the Load/Eject button and remove the jammed paper. (→P.138) (→P.166)
You have loaded and printed on a roll when sheets are selected as the paper source on the Control Panel .	Press the Load/Eject button, remove the roll, and load a sheet. Otherwise, select the roll as the media source on the Control Panel and reload the roll.

■ Cannot cut paper.

Cause	Corrective Action
There are sheets left on the Ejection Guide .	Remove the paper.
There is a foreign object by the Output Tray , obstructing the Cutter Unit .	Remove the foreign object.
You are not using the printer under the recommended environmental conditions for the paper.	Use the printer only where the recommended environmental conditions for the paper are met. Note that various environmental conditions are recommended for various types of paper. For details on the recommended environmental conditions for paper, see "Types of Paper". (→P.108)
You are using paper that is not compatible with automatic cutting.	Cut the roll manually. (→P.129)
The Cutter Unit stops in the middle of cutting.	Move the Cutter Unit to the left, and then remove the roll paper. If the roll cannot be cut using the Cutter Unit , cut the roll manually. (→P.129)
In other cases, the Cutter Unit may be damaged.	Contact your Canon dealer for assistance.

■ ■ ■ The roll is empty.

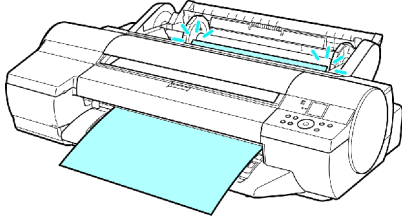
Cause	Corrective Action
<p>There is no more paper left on the roll.</p> 	<p>Follow the steps below to replace the used roll with a new roll of the same type and size.</p> <ol style="list-style-type: none"> 1. Remove the roll. (→P.122) (→P.118) 2. Load the new roll. (→P.119) 3. If no barcode was printed on the roll, specify the paper type. (→P.124) 4. If no barcode was printed on the roll, specify the paper length. (→P.125)

■ ■ ■ Roll feed unit err

Cause	Corrective Action
<p>The Roll Feed Unit is not working.</p>	<p>Turn off the printer, remove the Roll Feed Unit momentarily, and then reinstall it. (→P.147) (→P.148)</p>
	<p>If the message is still displayed after you do this, contact your Canon dealer for assistance.</p>

■ ■ ■ No Roll Feed Unit.

Cause	Corrective Action
<p>The printer has received a print job that specifies rolls, but the Roll Feed Unit is not installed.</p>	<p>Install the Roll Feed Unit and resend the print job. (→P.148)</p>

Messages regarding ink

☐ Ink Level: Check

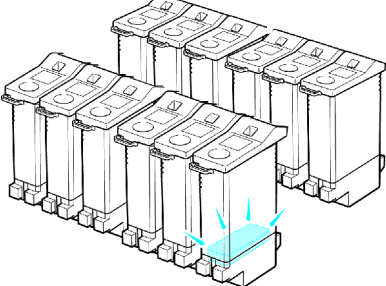
Cause	Corrective Action
<p data-bbox="172 418 411 448">Not much ink is left.</p> 	<p data-bbox="826 418 1458 551">Prepare a new Ink Tank . We recommend replacing the Ink Tank with a new Ink Tank at this point if you plan to print large-format or high-quantity jobs.</p>

☐ No ink tank loaded.

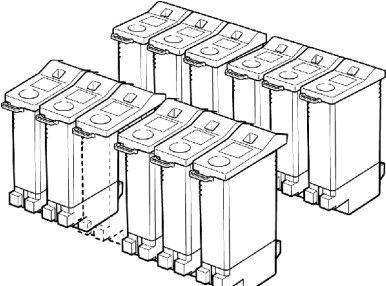
Cause	Corrective Action
<p data-bbox="172 909 756 972">There is no Ink Tank of the indicated color in the printer.</p> 	<p data-bbox="826 909 1166 972">Load or reload the Ink Tank . (→P.614)</p>
<p data-bbox="172 1299 624 1328">There is a problem with the Ink Tank .</p>	<p data-bbox="826 1299 1203 1361">Replace it with a new Ink Tank . (→P.614)</p>

Ink insufficient.

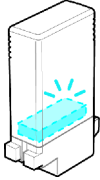
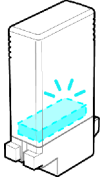
Cause	Corrective Action
<p>The ink level is low, so you cannot clean the Printhead .</p> 	<p>Press the OK button and replace the Ink Tank that is low with a new Ink Tank . (→P.614)</p>
<p>The ink level is low, so there may not be enough ink to finish printing.</p> 	<p>Press the OK button and replace the Ink Tank that is low with a new Ink Tank . (→P.614)</p> <p>You can print until the ink runs out by pressing the Online button. However, if the ink runs out during printing, the following situation will occur depending on the position of the leading edge when it passes through the printer.</p> <ol style="list-style-type: none"> 1. Ink tank is empty. is displayed and printing stops. Press the Stop button to cancel printing, or press the OK button, replace the ink tank that is low with a new one, and continue printing. However, note that because printing is paused, colors may be slightly different. (→P.614) 2. Ink tank empty. Canceling printing of this page. is displayed and printing stops. After the paper is ejected, press the OK button and replace the ink tank that is low with a new one. (→P.614)

■ Ink tank is empty.

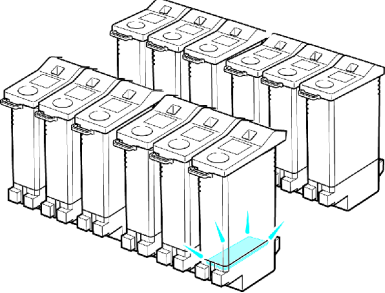
Cause	Corrective Action
<p data-bbox="169 271 403 297">There is no ink left.</p> 	<p data-bbox="823 271 1430 367">Open the Ink Tank Cover and replace the Ink Tank for which the Ink Lamp is flashing. (→P.614)</p>

■ Ink tank error.

Cause	Corrective Action
<p data-bbox="169 763 679 790">The Ink Tank in the printer is incompatible.</p>	<p data-bbox="823 763 1430 826">Load an Ink Tank specified for use with the printer. (→P.614)</p>

■ Remaining level of the ink cannot be correctly detected.

Cause	Corrective Action
<p data-bbox="169 994 778 1057">Ink level detection cannot work correctly if you use refill ink tanks.</p>	<p data-bbox="823 994 1453 1093">The refill ink tank can no longer be used. See the section “Ink level detection” and take the appropriate action. (→P.685)</p>

Messages regarding printing or adjustment

Use another paper.

Cause	Corrective Action
The Printhead and feed amount cannot be adjusted when highly transparent film is loaded.	For automatic Printhead adjustment, we recommend using a type of paper that you often use, other than film. (→P.584)
	Adjust the feed amount manually. (→P.592)

Cannot execute this command. Use other paper.

Cause	Corrective Action
The loaded paper cannot be used for color calibration.	Load paper compatible with color calibration.*1 See "Paper Reference Guide ." (→P.108)

*1: Always make sure the loaded paper matches the media type setting on the printer. Adjustment cannot be completed correctly unless the setting value matches the loaded paper.

Cannot print as specified.

Press Load/Eject and replace paper with A4/LTR (vertical) or larger

Cause	Corrective Action
The loaded paper is too small.	Press the Load/Eject button and switch to paper A4/Letter, vertical, or larger.

Press Load/Eject and replace roll with 10 in. wide or larger roll.

Cause	Corrective Action
The loaded paper is too small.	Press the Load/Eject button and load a roll at least 10 inches (254 mm) wide.

Cannot adjust band.

Cause	Corrective Action
The Printhead nozzles are clogged.	Follow the steps below to check the nozzles. 1. Print a test pattern to check the nozzles. (→P.623) 2. Clean the Printhead if the nozzles are clogged. (→P.624)
Highly transparent film is loaded that cannot be used for feed amount adjustment.	Adjust the feed amount manually. (→P.592)

Cannot adjust printhead.

Cause	Corrective Action
The Printhead nozzles are clogged.	Follow the steps below to check the nozzles. 1. Print a test pattern to check the nozzles. (→P.623) 2. Clean the Printhead if the nozzles are clogged. (→P.624)
Highly transparent film is loaded that cannot be used for Printhead adjustment.	We recommend using a type of paper that you often use, other than film, for Printhead adjustment. (→P.584)

Excessive temperature or humidity.

Cause	Corrective Action
The temperature or humidity where the printer is installed is out of the acceptable range for printer operation.	Press the Stop button and stop printing. Use the printer in an environment that meets the requirements for the operating environment. Note that various environmental conditions are also recommended for various types of paper. For details on the recommended environmental conditions for paper, see "Paper Reference Guide ." (→P.108)
	Press the OK button and complete color calibration. However, calibration may not be completed successfully.

Cannot calibrate.

Cause	Corrective Action
The paper for printing a test pattern for adjustment is soiled. Otherwise, colored paper is loaded.	Load unused paper compatible with color calibration. (→P.108)
The printed test pattern is faint.	Take steps to remedy the faint printing. (→P.663)
Direct sunlight or strong lighting may be shining on the printer and causing the sensor to malfunction.	Take steps to ensure the printer is not used when exposed to direct sunlight or strong lighting.

Messages regarding printheads

Cannot adjust printhead.

Cause	Corrective Action
The Printhead nozzles are clogged.	Follow the steps below to check the nozzles. 1. Print a test pattern to check the nozzles. (→P.623) 2. Clean the Printhead if the nozzles are clogged. (→P.624)
Highly transparent film is loaded that cannot be used for Printhead adjustment.	We recommend using a type of paper that you often use, other than film, for Printhead adjustment. (→P.584)

Cannot adjust band.

Cause	Corrective Action
The Printhead nozzles are clogged.	Follow the steps below to check the nozzles. 1. Print a test pattern to check the nozzles. (→P.623) 2. Clean the Printhead if the nozzles are clogged. (→P.624)
Highly transparent film is loaded that cannot be used for feed amount adjustment.	Adjust the feed amount manually. (→P.592)

x printhead needs cleaning. (x is Left or Right)

Cause	Corrective Action
The Printhead nozzles are clogged.	Specify Printhead cleaning options. (→P.624) If the message is still displayed after you execute Head Cleaning B two or three times, contact your Canon dealer for assistance.

PHeads: wrong pos.

Cause	Corrective Action
The left Printhead is installed in the right position and vice versa.	Turn off the printer and wait at least three seconds before restoring the power. If the message is displayed again, contact your Canon dealer for assistance.

Problem with Printhead x (x is L, R, or LR)

Cause	Corrective Action
The Printhead nozzles are becoming clogged.	If printing is faint, clean the Printhead . (→P.624)

x printhead error (x is Left or Right)

Cause	Corrective Action
An incompatible Printhead has been installed.	Install a Printhead specified for use with the printer. If “Printhead L” is displayed, install the Printhead L ; if “Printhead R” is displayed, install the Printhead R . (→P.625)
There is a problem with the Printhead .	Open the Top Cover . If the Carriage is over the Platen , replace the Printhead with a new one. If “Printhead L” is displayed, replace the Printhead L ; if “Printhead R” is displayed, replace the Printhead R . (→P.625)
	If, after opening the Top Cover , you see that the Carriage is not over the Platen , follow the steps below. <ol style="list-style-type: none"> 1. Close the Top Cover and press the Online button. 2. If “Printhead L” is displayed, install the Printhead L ; if “Printhead R” is displayed, install the Printhead R . (→P.625)

Messages regarding the maintenance cartridge

⚡ No maintenance cartridge.

Cause	Corrective Action
The Maintenance Cartridge is not installed.	Install the Maintenance Cartridge . (→P.632)

⚡ Prepare for maint cart replacement.

Cause	Corrective Action
The Maintenance Cartridge is almost full.	You can continue to print, but prepare a new Maintenance Cartridge to use when the message for replacement is displayed.

⚡ No Maintenance Cartridge capacity.

Cause	Corrective Action
The Maintenance Cartridge cannot absorb enough ink for Printhead cleaning or other operation.	After confirming that the printer has stopped operating, replace the Maintenance Cartridge . (→P.632)

⚡ Maintenance cartridge full.

Cause	Corrective Action
The Maintenance Cartridge is full.	After confirming that the printer has stopped operating, replace the Maintenance Cartridge . (→P.632)

⚡ Maintenance cartridge problem.

Cause	Corrective Action
An incompatible or used Maintenance Cartridge has been installed.	Install an unused Maintenance Cartridge specified for use with the printer. (→P.632)

Other Messages

■ ■ ■ GARO Wxxxx (x represents a number)

Cause	Corrective Action
There is a problem with the print job.	Try printing again, using the correct printer driver.
	It is also possible to continue printing in this state. However, you may not be able to obtain the desired printing results.

■ ■ ■ Top cover is open.

Cause	Corrective Action
The printer has detected that the Top Cover is open.	Open the Top Cover fully, remove any foreign objects, and close the Top Cover again.
	If the error occurs again, turn off the printer and wait a while before restoring power.

■ ■ ■ ERROR Exxx-xxxx (x represents a letter or number)

In the following situations, turn off the printer and wait at least three seconds before restoring power. If the message is still displayed, write down the error code and message, turn off the printer, and contact your Canon dealer for assistance.

- “ERROR” is displayed, followed by the error code and **Call for service**.

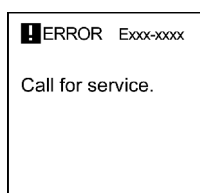

■ ■ ■ Unknown file.

Cause	Corrective Action
Invalid data format.	Check the print job and resend it.

■ ■ ■ Prepare for parts replacement.

Cause	Corrective Action
It is almost time to replace consumables for which service is required.	If Parts replacement time has passed. is displayed, you can continue to use the printer for some time. Contact your Canon dealer for assistance.

■ ■ ■ Parts replacement time has passed.

Cause	Corrective Action
It is past the recommended time to replace consumables for which service is required.	Contact your Canon dealer for assistance.

☐☐☐ Multi-sensor error

Cause	Corrective Action
Direct sunlight or strong lighting may be shining on the printer and causing the sensor to malfunction.	Take steps to ensure the printer is not used when exposed to direct sunlight or strong lighting.
The performance of a sensor inside the printer may be impaired.	Contact your Canon dealer for assistance.

☐☐☐ Roll feed unit err

Cause	Corrective Action
The Roll Feed Unit is not working.	Turn off the printer, remove the Roll Feed Unit momentarily, and then reinstall it. (→P.147) (→P.148)
	If the message is still displayed after you do this, contact your Canon dealer for assistance.

☐☐☐ No Roll Feed Unit.

Cause	Corrective Action
The printer has received a print job that specifies rolls, but the Roll Feed Unit is not installed.	Install the Roll Feed Unit and resend the print job. (→P.148)

☐☐☐ Hardware error. xxxxxxxx-xxxx (x represents a letter or number)

In the following situations, turn off the printer and wait at least three seconds before restoring power. However, keep the printer off and remove the roll if the last portion of roll paper was used during a print job and paper could not be advanced because the trailing edge is taped to the roll. If tape and the Belt Stopper have not been removed from inside the Top Cover, turn off the printer, open the Top Cover, and remove the tape and Belt Stopper before restoring power.

If the message is still displayed, write down the error code and message, turn off the printer, and contact your Canon dealer for assistance.

- The error message is displayed with the following instructions: **Turn off printer, wait, then turn on again.**

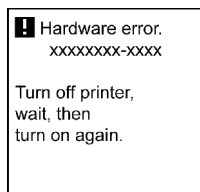

Index

A

- A message to check the Maintenance Cartridge is not cleared after you replace the Maintenance Cartridge.....683
- About This User Manual..... 1
- Accessing the Printer Driver Dialog Box from Applications (Mac OS 9).....535
- Accessing the Printer Driver Dialog Box from Applications (Mac OS X) 511
- Accessing the Printer Driver Dialog Box from Applications (Windows) 473, 611
- Accessing the Printer Driver Dialog Box from the Operating System Menu (Windows)..... 149, 475
- Additional Settings Pane (Mac OS 9).....528
- Additional Settings Pane (Mac OS X)505
- Adjusting Color on the Trailing Edge of Sheets.....598
- Adjusting the Color in the Printer Driver 184
 - Color Adjustment 184
 - Color Mode..... 184
 - Gray Tone Adjustment..... 187
 - Matching..... 185
- Adjusting the feed amount.....589
- Adjusting the Feed Amount Automatically589
 - Adjusting the feed amount during printing.....591
- Adjusting the Feed Amount Manually592
 - Adjusting the feed amount during printing.....594
- Adjusting the Measurement Scale for Better Accuracy.....596
- Adjusting the Printhead584
- Adjusting the Printhead Alignment Automatically ...584
- Adjusting the Printhead Alignment Manually586
- Adjusting the Printhead Height.....588
- Adjusting the Vacuum Strength595
- An error message is shown on the Display Screen662
- Attaching Accessories to the Roll Holder 144
 - Attaching the Spacer for Borderless Printing ... 145
 - Mounting the 3-Inch Paper Core Attachment ... 144
 - Removing the 3-Inch Paper Core Attachment.. 144
 - Removing the Spacer for Borderless Printing .. 145

B

- Back9
- Banding in different colors occurs666
- Basic Environmental Performance77
 - Packaging materials77
 - Printer.....77
- Basic Printing Workflow.....80
- Borderless Printing297
- Borderless Printing at Actual Size279, 301
 - Borderless Printing279, 301
 - Borderless Printing Method279, 301
 - Print Image with Actual Size.....280, 302
- Borderless Printing at Actual Size (Mac OS 9)286, 308
- Borderless Printing at Actual Size (Mac OS X).....283, 305
- Borderless Printing at Actual Size (Windows)281, 303
- Borderless Printing by Resizing Originals to Fit the Roll Width299
 - Borderless Printing299
 - Borderless Printing Method299
 - Scale to fit Roll Paper Width.....300
- Borderless Printing by Resizing Originals to Fit the Roll Width (Mac OS 9).....317
- Borderless Printing by Resizing Originals to Fit the Roll Width (Mac OS X)314
- Borderless Printing by Resizing Originals to Fit the Roll Width (Windows)312
- Borderless Printing by Resizing Originals to Match the Paper Size (Mac OS 9)326
- Borderless Printing by Resizing Originals to Match the Paper Size (Mac OS X)323
- Borderless Printing by Resizing Originals to Match the Paper Size (Windows)321
- Borderless Printing on Paper of Equivalent Size....297
 - Borderless Printing297
 - Borderless Printing Method297
 - Fit Media Size.....298
- Borderless printing not possible.696
 - Check roll width and spacers.696
 - Check supported paper.696
- By selecting color tones on Charts before printing (Windows)604

- C**
- Canceling print jobs 99
 - Canceling Print Jobs from Mac OS 9 105
 - Canceling background print jobs 105
 - Canceling foreground print jobs 106
 - Canceling Print Jobs from Mac OS X 103
 - Canceling Print Jobs from the Control Panel 99
 - Canceling Print Jobs from Windows 101
 - Cannot adjust band. 704, 706
 - Cannot adjust printhead. 705, 706
 - Cannot calibrate. 705
 - Cannot connect the printer to the network 657
 - Cannot cut paper. 699
 - Cannot detect paper 698
 - Cannot execute this command. Use other paper. .. 704
 - Cannot feed paper 695, 698
 - Cannot Load Sheets 684
 - Cannot print as specified 704
 - Cannot print over a NetWare network 661
 - Cannot print over a network 657
 - Cannot print over a TCP/IP network 659
 - Cannot print over AppleTalk or Bonjour networks .. 660
 - Carriage 13
 - Centering originals 378
 - Checking for Nozzle Clogging 623
 - Checking Ink Tank Levels 620
 - Checking the Layout Before Printing 495
 - Preview (Macintosh) 495
 - Checking the Layout Before Printing (Mac OS X) .. 496
 - Checking the Print Quality 622
 - Checking the Remaining Maintenance Cartridge Capacity 637
 - Choosing a Paper for Printing 172
 - If the paper type is not listed for selection 172
 - Media type 172
 - Choosing the Document Type and Printing Conditions (Mac OS 9) 195
 - Choosing the Document Type and Printing Conditions (Mac OS X) 192
 - Choosing the Document Type and Printing Conditions (Windows) 190
 - Cleaning Inside the Top Cover 640
 - Cleaning Spurs Used in Paper Feeding 644
 - Cleaning the Paper Retainer 643
 - Cleaning the Printer 639
 - Cleaning the Printer Exterior 639
 - Cleaning the Printhead 624, 647
 - Cleaning the Printhead 624, 647
 - Clearing jammed paper 674
 - Clearing Jammed Paper (Paper Feed Slot) ... 142, 678
 - Clearing Jammed Paper from the Tray 166, 679
 - Clearing Jammed Roll Paper 138, 674
 - Color adjustment 600
 - Color Settings Pane: Color (Mac OS 9) 537
 - Color Adjustment pane: color 537
 - Matching pane 539
 - Object Adjustment dialog box 538
 - Color Settings Pane: Color (Mac OS X) 512
 - Color Adjustment pane: color 512
 - Matching pane 513
 - Color Settings Pane: Monochrome (Mac OS 9) 540
 - Color Adjustment pane: monochrome 540
 - Object Adjustment dialog box 541
 - Color Settings Pane: Monochrome (Mac OS X) 514
 - Color Adjustment pane: monochrome 514
 - Color Settings Sheet: Color (Windows) 477
 - Color Adjustment : color 477
 - Light Source Check Tool 482
 - Matching sheet: Ambient Light Matching Mode (Kyuanos) 481
 - Matching sheet: Driver Matching Mode 479
 - Matching sheet: ICC Matching Mode, Driver ICM Mode, and Host ICM Mode 480
 - Object Adjustment dialog box 478
 - Color Settings Sheet: Monochrome (Windows) 483
 - Color Adjustment : monochrome 483
 - Object Adjustment dialog box 484
 - Colors in printed images are uneven 667
 - Configuring NetWare Network Settings 566
 - Configuring the Communication Mode Manually ... 658
 - Configuring the Destination for AppleTalk Network (Macintosh) 574
 - Activating AppleTalk on the printer 574
 - Configuring the Destination (Mac OS 9) 575
 - Configuring the Destination (Mac OS X) 576
 - Configuring the Destination for Bonjour Network (Macintosh) 582
 - Configuring the Destination for TCP/IP Network (Macintosh) 578
 - Configuring the Destination (Mac OS 9) 578
 - Configuring the Destination (Mac OS X) 580
 - Configuring the IP Address on the Printer 547
 - Configuring the IP Address Using ARP and PING Commands 552

- Configuring the IP Address Using imagePROGRAF Device Setup Utility471, 571
- Configuring the IP Address Using the Printer Control Panel.....551
- Configuring the Printer Driver Destination (Macintosh).....573
- Configuring the Printer Driver Destination (Windows)567
- Configuring the Printer's AppleTalk Network Settings572
- Configuring the Printer's NetWare Network Settings557
- Configuring the Printer's TCP/IP Network Settings549
- Confirming Print Settings (Mac OS 9)518
- Checking a preview of the settings.....518
 - Checking a print preview519
- Confirming Print Settings (Mac OS X).....493
- Checking a preview of the settings.....493
 - Checking a print preview494
- Confirming Print Settings (Windows).....443
- Checking a preview of the settings.....443
 - Checking a print preview444
- Confirming the Print Image Before Printing485
- Conserving roll paper395
- Conserving Roll Paper by Printing Originals Without Top and Bottom Margins396
- No Spaces at Top or Bottom (Conserve Paper)396
- Conserving Roll Paper by Printing Originals Without Top and Bottom Margins (Mac OS 9)402
- Conserving Roll Paper by Printing Originals Without Top and Bottom Margins (Mac OS X).....399
- Conserving Roll Paper by Printing Originals Without Top and Bottom Margins (Windows)397
- Conserving Roll Paper by Rotating Originals 90 Degrees.....395
- Rotate Page 90 degrees (Conserve Paper)395
- Conserving Roll Paper by Rotating Originals 90 Degrees (Mac OS 9)409
- Conserving Roll Paper by Rotating Originals 90 Degrees (Mac OS X)406
- Conserving Roll Paper by Rotating Originals 90 Degrees (Windows).....404
- Control Panel.....15, 19
- Correcting Print Misalignment584
- Cutting Roll Paper After Printing.....421
- Automatic Cutting421
- Cutting Roll Paper After Printing (Mac OS 9)427
- Cutting Roll Paper After Printing (Mac OS X).....425
- Cutting Roll Paper After Printing (Windows).....424
- Cutting the Leading Edge of Roll Paper Automatically128
-
- ## D
-
- Depression on the leading edge is left684
- Detection of the Remaining Roll Paper127
- Device Settings Pane (Mac OS 9).....527
- Device Settings Sheet (Windows)462
- Digital Photo Front-Access.....472
- Documents are printed crooked670
- Documents are printed in monochrome668
-
- ## E
-
- Email Notification When Printing is Finished or Errors Occur556
- End of paper feed.....698
- Enhanced Printing Options.....172
- ERROR Exxx-xxxx (x represents a letter or number)709
- Error Message687
- Error Messages689
- Error messages (if action can be taken).....689
 - Error messages (if no action can be taken).....690
 - Other Messages690
 - Warning messages.....689
- Excessive temperature or humidity.....705
-
- ## F
-
- Favorites Sheet (Windows)459
- Feeding Paper from the Roll Feed Unit.....146
- Feeding Roll Paper Manually126
- Fine-Tuning Colors of Photos and Images (Mac OS 9)204
- Fine-Tuning Colors of Photos and Images (Mac OS X).....201
- Fine-Tuning Colors of Photos and Images (Windows)198
- Fine-Tuning Monochrome Settings When Printing Photos (Mac OS 9).....212
- Fine-Tuning Monochrome Settings When Printing Photos (Mac OS X)209
- Fine-Tuning Monochrome Settings When Printing Photos (Windows)207
- Finishing Pane (Mac OS 9)525
- Frequently Asked Questions653
- Front8

G

GARO Wxxxx (x represents a number)	709
Giving Priority to Particular Graphic Elements and Colors for Printing.....	173
Advanced Settings	173
Color Settings.....	175
Enhancing Printing Quality	176
Print Priority.....	173
Print Quality.....	174
Gray Adjustment Pane (Mac OS 9)	526
Gray Adjustment.....	526
Gray Adjustment Pane (Mac OS X).....	504
Gray Adjustment.....	504
Gray Adjustment Sheet (Windows)	458
Gray Adjustment.....	458

H

Handling Paper.....	107
Handling rolls.....	115
Handling sheets for paper feed slots.....	154
Hardware error. xxxxxxxx-xxxx (x represents a letter or number)	710
How to use this manual	1
HTML Version of the Manual for Printing.....	4

I

IEEE 1394 Expansion Board.....	71
If the Printer Makes a Strange Sound	682
Image Edges are Blurred or White Banding Occurs	670
imagePROGRAF Device Setup Utility.....	469
imagePROGRAF Printmonitor (Macintosh)....	510, 534
imagePROGRAF Status Monitor (Windows).....	468
Immediately After Borderless Printing, the Trailing Edge Margin is Soiled During Regular Printing	670
Improving the Print Quality	622
Initializing the Network Settings	548
Ink insufficient.....	702
Ink level detection.....	685
Disabling Ink Level Detection	685
Ink level detection.....	685
Ink Level: Check.....	701
Ink Tank	613
Ink Tank Cover (Inside).....	14
Ink tank error.	703
Ink tank is empty.....	703
Ink Tanks	613

Installation problems	672
Installing imagePROGRAF Device Setup Utility.....	470, 570
Installing the Roll Feed Unit	148
Insufficient paper for job	693
Introduction.....	1

L

Layout Sheet (Windows)	456
Line thickness is not uniform (Windows)	671
Lines are misaligned	668
Loading and Printing on Rolls	80
Loading and Printing on Sheets in the Paper Feed Slot	85
Loading Rolls in the Roll Feed Unit.....	119
Loading Rolls on the Roll Paper Holder	116
Loading Sheets Manually	156
Loading heavyweight paper in the Front Paper Feed Slot.....	158
Loading paper in the Top Paper Feed Slot.....	156

M

Mac OS 9	517
Mac OS X.....	492
Main Menu Operations	30
Accessing Menus	31
Executing menu commands	34
Specifying menu items	32
Specifying numerical values.....	33
Main Menu Settings.....	49
Adjust Printer.....	53
Information	58
Interface Setup	54
Maintenance.....	55
Media Menu.....	50
Paper Details.....	51
System Setup	56
Main Menu Settings (During Printing)	59
Information	60
Main Pane (Mac OS 9).....	521
Configuration using Advanced Settings.....	522
Configuration using Easy Settings	521
Main Pane (Mac OS X)	499
Configuration using Advanced Settings.....	500
Configuration using Easy Settings	499
Main Sheet (Windows)	450
Configuration using Advanced Settings.....	452
Configuration using Easy Settings	450

Maintenance	584
Maintenance Cartridge	632
Maintenance cartridge full.	708
Maintenance cartridge problem.	708
Making the Original Orientation Match the Paper Orientation	420
Mirror	420
Orientation	420
Rotate 180 degrees	420
Making the Original Orientation Match the Paper Orientation (Mac OS 9)	434
Making the Original Orientation Match the Paper Orientation (Mac OS X)	431
Making the Original Orientation Match the Paper Orientation (Windows)	429
Manual printing is selected, but a roll is loaded.	695
Media Detailed Settings Dialog Box (Mac OS 9)	153, 542
Media Detailed Settings Dialog Box (Mac OS X)	152, 515
Media Detailed Settings Dialog Box (Windows)	151, 486
Media Size Options Dialog Box (Windows)	487
Menu Structure	35
Main Menu	35
Main menu during printing	48
Submenus	47
Messages regarding ink	701
Messages regarding paper	691
Messages regarding printheads	706
Messages regarding printing or adjustment	704
Messages regarding the maintenance cartridge ...	708
Multi-sensor error	710

N

Network Environment	545
Network environment	546
System requirements	545
Network Setting	545
Network Setting (Macintosh)	572
Network Setting (Windows)	557
No ink tank loaded	701
No Maintenance Cartridge capacity	708
No maintenance cartridge.	708
No Roll Feed Unit	700, 710

O

Optional accessories	69
Other Maintenance	648
Other Messages	709
Other problems	683
Other useful settings	419
Output Stacker	169
Output Stacker Precautions	171

P

Page Setup Pane (Mac OS 9)	523
Page Setup Pane (Mac OS X)	501
Page Setup Sheet (Windows)	454
Paper	107
Paper Size	107
Paper Type	107
Paper cannot be cut	683
Paper Information on Printer Dialog Box (Mac OS X)	498
Paper Information on Printer Dialog Box (Windows)	446
Paper is not cut straight	683
Paper jam	699
Paper loaded askew.	697
Paper Mismatch	691
Paper rubs against the Printhead	664
Paper size not detected	697
Paper Sizes	113
Rolls	114
Sheets	113
Paprr Size Mismatch	692
Paprr Type Mismatch	691
Parts replacement time has passed.	709
PHeads: wrong pos.	706
Prepare for maint cart replacement	708
Prepare for parts replacement	709
Preparing to Transfer the Printer	648
Previewing Images Before Printing (Mac OS 9)	520
Previewing Images Before Printing (Mac OS X)	497
Previewing Images Before Printing (Windows)	445
Print Area	78
Rolls	79
Sheets	78
Print quality and color settings	172
Printed colors are inaccurate	669
Printer Driver Settings (Mac OS 9)	517
Printer Driver Settings (Mac OS X)	492

Index

Printer Driver Settings (Windows)	441	Printing from Photoshop	422
Printer Menu Operations	29	Using the Plug-in to Print.....	422
Printer Modes	21	Using the Printer Driver to Print.....	422
Menu mode, and state of the Control Panel.....	25	Printing from Windows	88
Mode transition.....	22	Printing in Colors Matching the Measured Ambient Light.....	608
Modes.....	21	Printing in Ideal Colors for Light in the Viewing Environment	188, 603
Offline, and state of the Control Panel	24	By selecting color tones on Charts before printing.....	188, 603
Online, and state of the Control Panel	23	Printing in Colors Matching the Measured Ambient Light	188, 603
Submenu mode, and state of the Control Panel.....	25	Printing is faint.....	663
Printer parts	8	Printing Large Posters (Mac OS 9)	359
Printer Specifications.....	72	Printing Large Posters (Windows).....	357
Printhead	622	Printing Line Drawings and Text (Mac OS 9).....	182, 220, 417
Printheads	622	Easy Settings	182
Printing Adobe RGB Images (Mac OS 9).....	531	Print Target	182
Printing Adobe RGB Images (Mac OS X).....	507	Print targets for line drawings and text.....	182
Printing Adobe RGB Images (Windows)	465	Printing Line Drawings and Text (Mac OS X).....	217, 414
Printing at full size	277	Printing Line Drawings and Text (Windows)	215, 412
Printing at Full Size (Mac OS 9)	295	Printing Line Drawings and Text (Windows, Mac OS X).....	181
Printing at Full Size (Mac OS X).....	292	Easy Settings	181
Printing at Full Size (Windows)	290	Print Target	181
Printing banners or at other non-standard sizes	330	Print targets for line drawings and text.....	181
Printing CAD Drawings.....	411	Printing Multiple Originals Next to Each Other	352
Printing does not start	656	Free Layout (Windows)	352
Printing Enlargements of Scanned Originals from a Color imageRUNNER.....	247	imagePROGRAF Free Layout (Macintosh).....	353
Printing Enlargements of Scanned Originals from a Color imageRUNNER (Mac OS X).....	250	Printing Multiple Originals Next to Each Other (Mac OS X).....	363
Completing the scanning settings on the Color imageRUNNER.	251	Printing Multiple Originals Next to Each Other (Windows)	361
Registering a hot folder on your computer	250	Printing Multiple Pages Continuously.....	354
Scanning the original and print an enlargement	251	Roll paper (banner)	354
Printing Enlargements of Scanned Originals from a Color imageRUNNER (Windows).....	248, 488	Printing Multiple Pages Continuously (Mac OS 9)	368
Completing the scanning settings on the Color imageRUNNER.	249, 489	Printing Multiple Pages Continuously (Mac OS X).....	366
Registering a hot folder on your computer	248, 488	Printing Multiple Pages Continuously (Windows)	365
Scanning the original and print an enlargement	249, 489	Printing Multiple Pages Per Sheet.....	355
Printing enlargements or reductions.....	244	Page Layout	355
Printing from Mac OS 9	91	Printing Multiple Pages Per Sheet (Mac OS 9)	375
Printing from the application software	92	Printing Multiple Pages Per Sheet (Mac OS X).....	372
Selecting the printer	91	Printing Multiple Pages Per Sheet (Windows).....	370
Printing from Mac OS X.....	89		
Printing from the application software	90		
Registering the printer	89		

- Printing Office Documents..... 183
- Easy Settings 183
 - Print Target..... 183
 - Print targets for office documents..... 183
- Printing Office Documents (Mac OS 9) 226
- Printing Office Documents (Mac OS X)..... 224
- Printing Office Documents (Windows)..... 222
- Printing on Non-Standard Paper Sizes 331
- Registering non-standard paper size in the printer driver 331
 - Specifying custom media sizes for temporary use..... 331
- Printing on Non-Standard Paper Sizes (Mac OS 9) 338
- Printing on Non-Standard Paper Sizes (Mac OS X)..... 336
- Printing on Non-Standard Paper Sizes (Windows) 332
- Printing by using Custom Media Size..... 334
 - Printing by using Custom Size 332
- Printing on Oversized Paper 277
- Oversize 277
- Printing Options Using Rolls and Sheets 87
- Paper Size..... 87
 - Printing Options Using Rolls and Sheets 87
 - Rolls and Sheets 87
- Printing Originals Centered on Rolls 378
- Centering originals relative to roll paper width .378
- Printing Originals Centered on Rolls (Mac OS 9) ... 385
- Printing Originals Centered on Rolls (Mac OS X) .. 382
- Printing Originals Centered on Rolls (Windows) 380
- Printing Originals Centered on Sheets 379
- Centering originals on sheets..... 379
- Printing Originals Centered on Sheets (Mac OS 9) 392
- Printing Originals Centered on Sheets (Mac OS X)..... 390
- Printing Originals Centered on Sheets (Windows) 388
- Printing Photos and Images (Mac OS 9)..... 179, 233
- Easy Settings 179
 - Print Target..... 179
 - Print targets for photos and images 179
- Printing Photos and Images (Mac OS X) 230
- Printing Photos and Images (Windows) 228
- Printing Photos and Images (Windows, Mac OS X) 177
- Easy Settings 177
 - Print Target..... 177
 - Print targets for photos and images 177
- Printing Photos in Monochrome 189
- Printing Photos in Monochrome (Mac OS 9)..... 241
- Printing Photos in Monochrome (Mac OS X) 238
- Printing Photos in Monochrome (Windows) 236
- Printing Posters in Sections 356
- Page Layout 356
- Printing procedure 80
- Printing Vertical or Horizontal Banners (Large-Format Printing) 330
- Fit Roll Paper Width 330
- Printing Vertical or Horizontal Banners (Large-Format Printing; Mac OS 9) 348
- Print the banner..... 350
 - Register a Custom Media Size..... 348
- Printing Vertical or Horizontal Banners (Large-Format Printing; Mac OS X)..... 345
- Print the banner..... 346
 - Register a Custom Page Size 345
- Printing Vertical or Horizontal Banners (Large-Format Printing; Windows) 341
- Creating the banner in the application..... 342
 - Printing the banner 342
 - Registering a Custom Media Size 341
- Printing With Watermarks..... 419
- Watermark..... 419
- Printing with Watermarks-COPY, FILE COPY, and so on (Mac OS 9) 438
- Printing with Watermarks-COPY, FILE COPY, and so on (Windows)..... 436
- Problem with Printhead x (x is L, R, or LR) 707
- Problems with the printing quality..... 663
- Problems with the printing quality caused by the type of paper 668

R

- Reducing Dust from Cutting Rolls 134
- Remaining level of the ink cannot be correctly detected..... 703
- Removing Heavyweight Paper from the Front Paper Feed Slot..... 165
- Removing Installed Printer Drivers..... 673
- Removing imagePROGRAF Device Setup Utility (Windows) 673
 - Removing imagePROGRAF Status Monitor (Windows) 673
 - Removing printer drivers (Windows) 673
 - Removing Printer Drivers and imagePROGRAF Printmonitor (Macintosh) 673
- Removing Rolls from the Roll Feed Unit 122
- Removing Rolls From the Roll Holder 118

Removing Sheets from the Top Paper Feed Slot ...	164	Roll Holder Set	70, 143
Removing the Roll Feed Unit	147	Roll paper cannot be inserted into the Paper Feed Slot	684
Replacing Ink Tanks	614	Roll Paper Unit Cover (Inside).....	12
Compatible Ink Tank.....	614	Roll printing is selected, but sheets are loaded.....	694
Precautions when handling an Ink Tank.....	614	Roll printing is selected.	694
Replacing an Ink Tank.....	615	Roller marks are left across the trailing edge of paper	671, 684
Replacing the Maintenance Cartridge	632		
Compatible Maintenance Cartridge.....	632	S	
Precautions when handling the Maintenance Cartridge.....	632	Selecting the Paper Size (Sheet)	163
Replacing the Maintenance Cartridge	633	Selecting the Paper Type (Roll).....	124
Replacing the Printhead	625	Selecting the Paper Type (Sheet).....	162
Compatible Printhead.....	625	Selecting the Roll as the Paper Source.....	115
Precautions when handling the Printhead.....	625	Selecting the Sheet as the Paper Source	154
Replacing the Printhead	626	Settings Summaries Dialog Box (Windows)	447
When to replace the Printhead.....	625	Sharing the Printer in Windows	568
Resizing Originals by Entering a Scaling Value.....	246	Sheet printing is selected.	694
Enlarged/Reduced Printing	246	Software	441
Scaling.....	246	Special Settings Dialog Box (Mac OS 9).....	543
Resizing Originals by Entering a Scaling Value (Mac OS 9)	257	Special Settings Dialog Box (Windows)	490
Resizing Originals by Entering a Scaling Value (Mac OS X).....	254	Specifications	72
Resizing Originals by Entering a Scaling Value (Windows)	252	Ink.....	74
Resizing Originals to Fit the Roll Width	245	Interface	73
Enlarged/Reduced Printing	245	Paper.....	75
Fit Roll Paper Width	245	Printer.....	72
Resizing Originals to Fit the Roll Width (Mac OS 9)	266	Printing performance	73
Resizing Originals to Fit the Roll Width (Mac OS X).....	263	Specifying NetWare Print Services.....	561
Resizing Originals to Fit the Roll Width (Windows)	261	Choosing the type of print services	561
Resizing Originals to Match the Paper Size	244	Using NWADMIN or PCONSOLE to set up the print server	562
Enlarged/Reduced Printing	244	Specifying NetWare Protocols.....	564
Fit Media Size.....	244	Specifying Paper in the Printer Driver	655
Resizing Originals to Match the Paper Size (Mac OS 9)	274	Specifying Paper in the Printer Driver (Mac OS 9) ..	97
Resizing Originals to Match the Paper Size (Mac OS X).....	271	Specifying Paper in the Printer Driver (Mac OS X) ..	95
Resizing Originals to Match the Paper Size (Windows)	269	Specifying Paper in the Printer Driver (Windows)	93
Responding to Error Messages.....	687	Specifying Printer-Related Information.....	554
Error messages (if action can be taken).....	687	Specifying the Cutting Method for Rolls	129
Error messages (if no action can be taken).....	687	Eject (waiting for ink to dry after printing)	130
Other Messages	688	Manual (when using media that cannot be cut using the Cutter Unit)	131
Warning messages.....	687	Paper Cutting (to have the roll cut at your specified position).....	133
Responding to Messages	687	Specifying the Ink Drying Time for Rolls.....	135
Roll feed unit err	700, 710	Mac OS 9	137
		Mac OS X.....	136
		Windows.....	135
		Specifying the Paper Length (Roll).....	125

Specifying the Printer's Frame Type.....	559
Specifying the frame type using imagePROGRAF Device Setup Utility	559
Specifying the frame type using the printer Control Panel.....	560
Stand	69
Status Print.....	62
Checking the information in the Status Print report	62
Printing Status Print Reports	62
Submenu Display	61
Information of the loaded paper	61
Printer information	61
Remaining Maintenance Cartridge capacity and ink levels.....	61
Support Pane (Mac OS X).....	506
Support Sheet (Windows)	461
Switching Modes	26
Switching the Printer Online/Offline.....	26
Switching to Menu Mode	28

T

The back side of the paper is dirty	666
The contrast becomes uneven during printing	667
The Data lamp on the Control Panel does not light up.....	656
The Display Screen indicates the system is filling with ink	656
The edges of the paper are dirty	665
The IEEE 1394 Driver Cannot Be Installed Correctly	672
The length of printed images is inaccurate.....	668
The printer consumes a lot of ink	683
The printer does not go on	684
The Printer Does Not Respond Even if Print Jobs are Sent.....	656
The printer ejects blank, unprinted paper	662
The printer stops during a print job.....	662
The roll is empty.	700
The surface of the paper is dirty.....	666
This paper cannot be used.....	692
Tiling and multiple pages per sheet.....	352
Top Cover (Inside)	10
Top cover is open.	709
Tray Feed Area.....	11
Troubleshooting.....	653
Turning the Printer On and Off	19
Turning the printer off	20
Turning the printer on	19

Types of Paper	108
Updating paper information	111
Viewing the Paper Reference Guide	108

U

Unknown file.....	709
Updating the Firmware	652
Confirming the firmware version.....	652
Updating the firmware	652
Use another paper.....	704
Using Color Calibration to Adjust Colors	600
Using Favorites	421
Favorites.....	421
Using Favorites (Mac OS 9)	529
Printing using the favorite.....	529
Registering a favorite	529
Using Favorites (Mac OS X).....	506
Using Favorites (Windows)	448
Printing using the favorite.....	449
Registering a favorite	448
Using PosterArtist to Compose Originals	423
Edit Using PosterArtist	423
Using PosterArtist to Compose Originals (Windows)	463
Using RemoteUI	555
Using the Output Stacker	169
Utility Pane (Mac OS X)	503
Utility Sheet (Windows)	460

V

Vents	18
View Settings Dialog Box for the Printing Application (Mac OS 9)	544
View Settings Dialog Box for the Printing Application (Mac OS X).....	516
View Settings Dialog Box for the Printing Application (Windows)	491
Viewing Videos of Explanations	3

W

When to Replace Ink Tanks.....	621
Before print jobs and maintenance that consume a lot of ink	621
If a message for checking the ink is shown on the Display Screen	621
If a message for ink replacement is shown on the Display Screen	621

Index

When to Replace the Maintenance Cartridge	638
If a message for checking the Maintenance Cartridge is shown on the Display Screen	638
If a message for the Maintenance Cartridge replacement is shown on the Display Screen ..	638
When much of the Maintenance Cartridge capacity is depleted.....	638
White dots about 1 mm (0.039 in) apart appear on printed documents, in the direction paper is fed.....	670
Windows.....	441
Wrong paper feed slot for this paper type.	695

X

x printhead error (x is Left or Right).....	707
x printhead needs cleaning. (x is Left or Right)	706

